

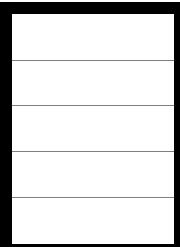

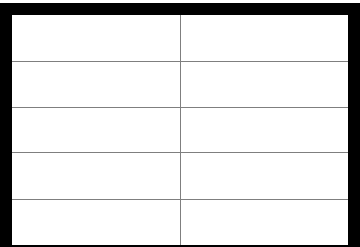

Grafomotricidad formas y cenefas

										

Grafomotricidad formas y cenefas



Grafomotricidad formas y cenefas

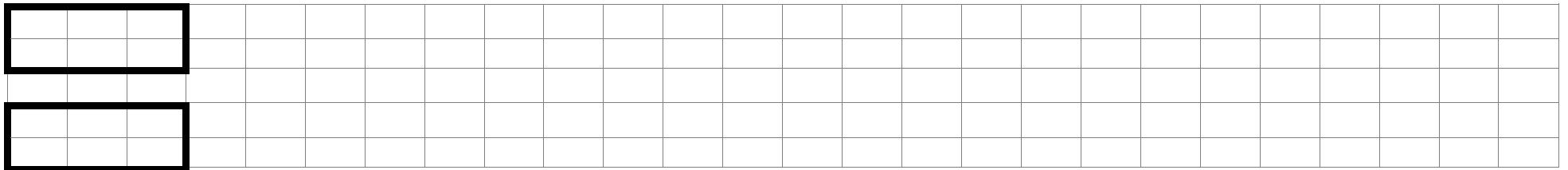
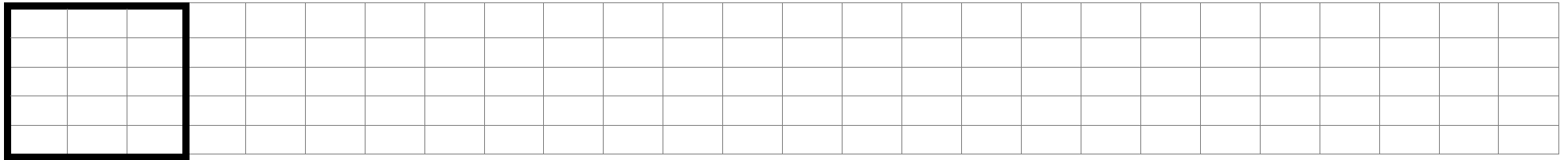
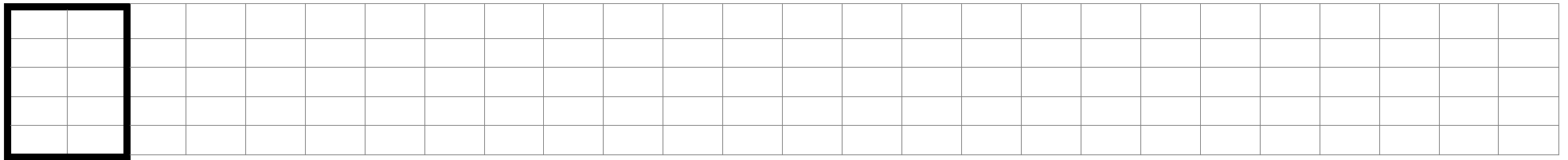
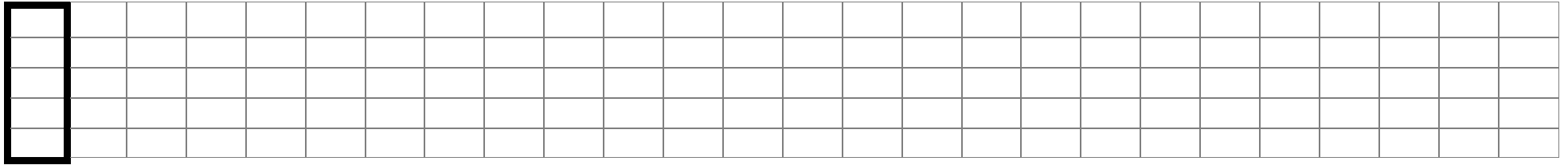

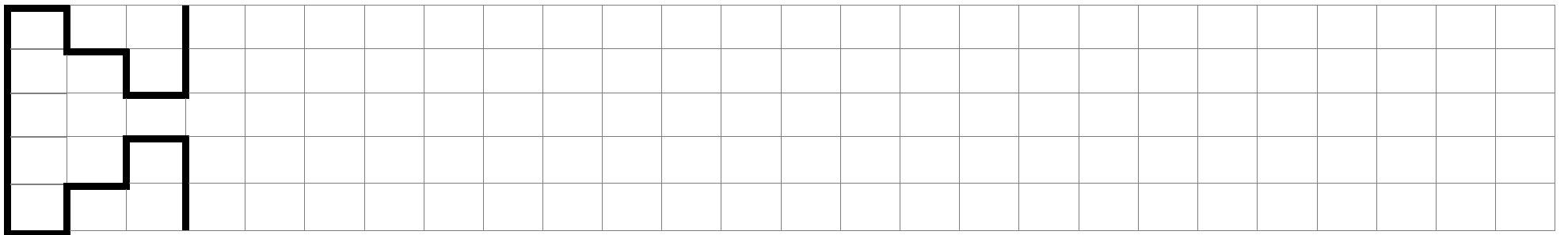
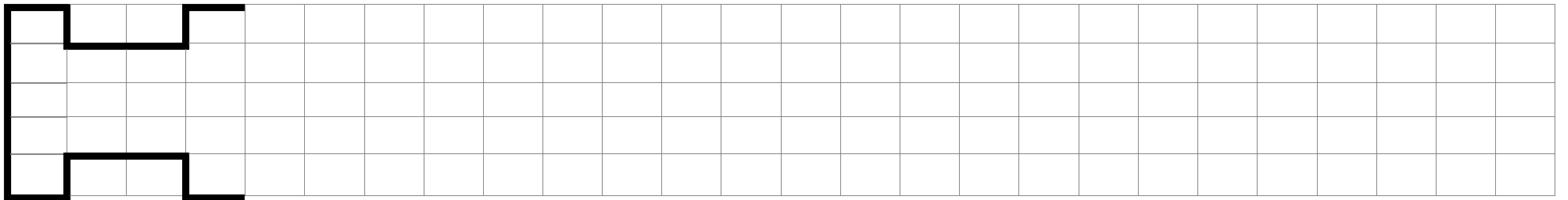
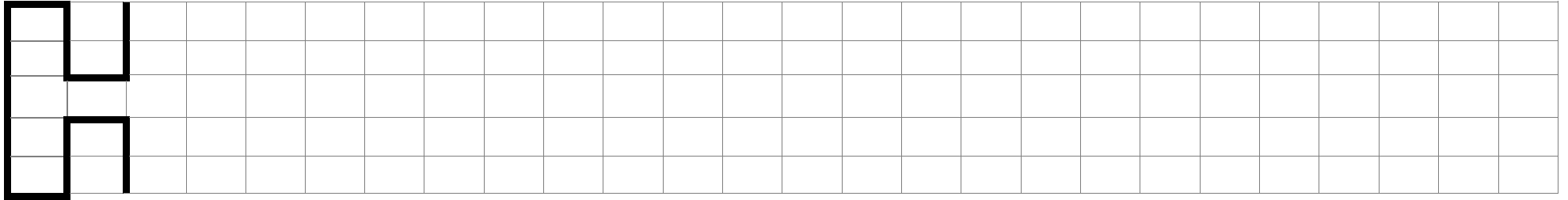
Dibuja siguiendo la línea de puntos la figura geométrica

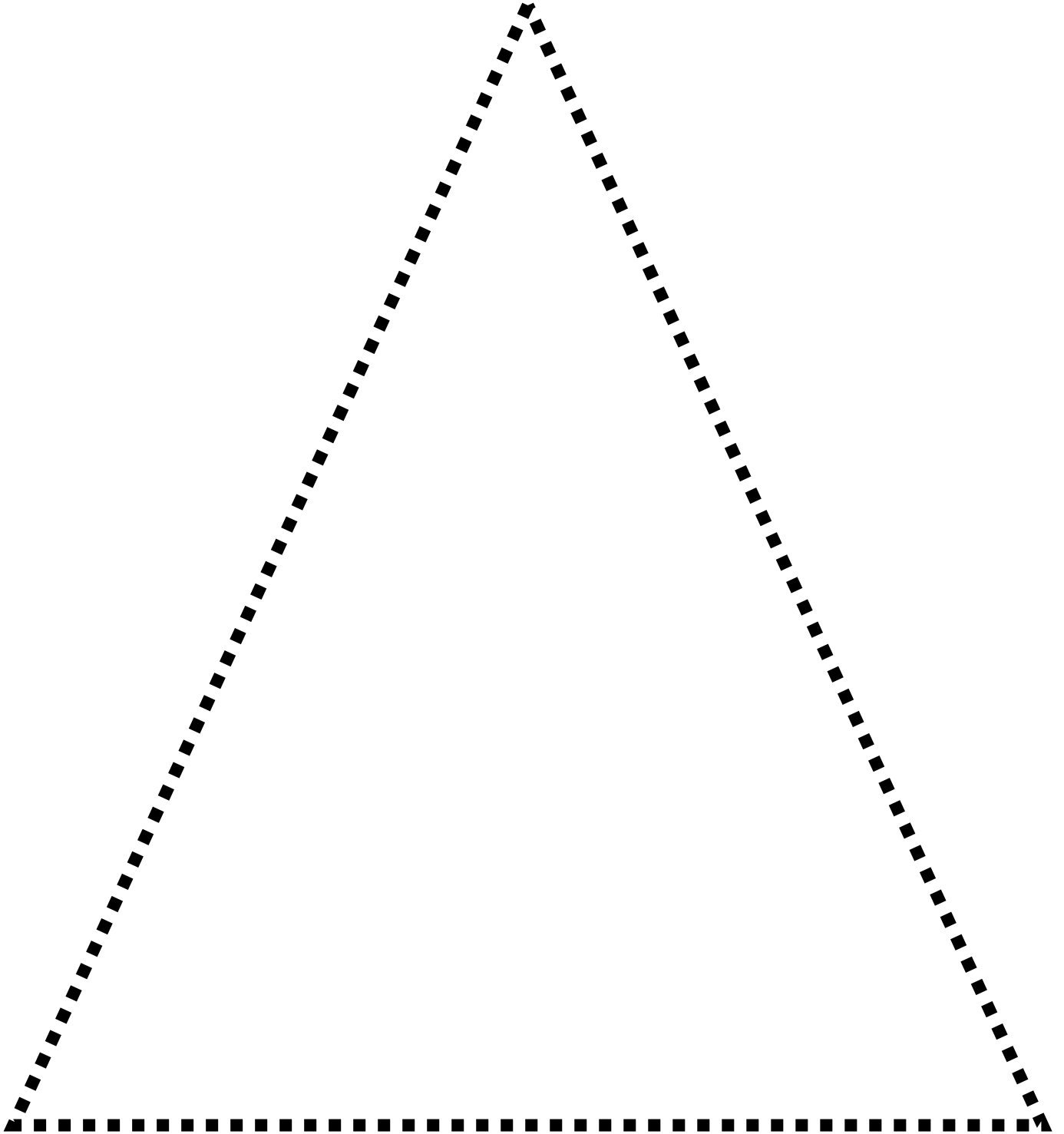

Dibuja siguiendo la línea de puntos la figura geométrica

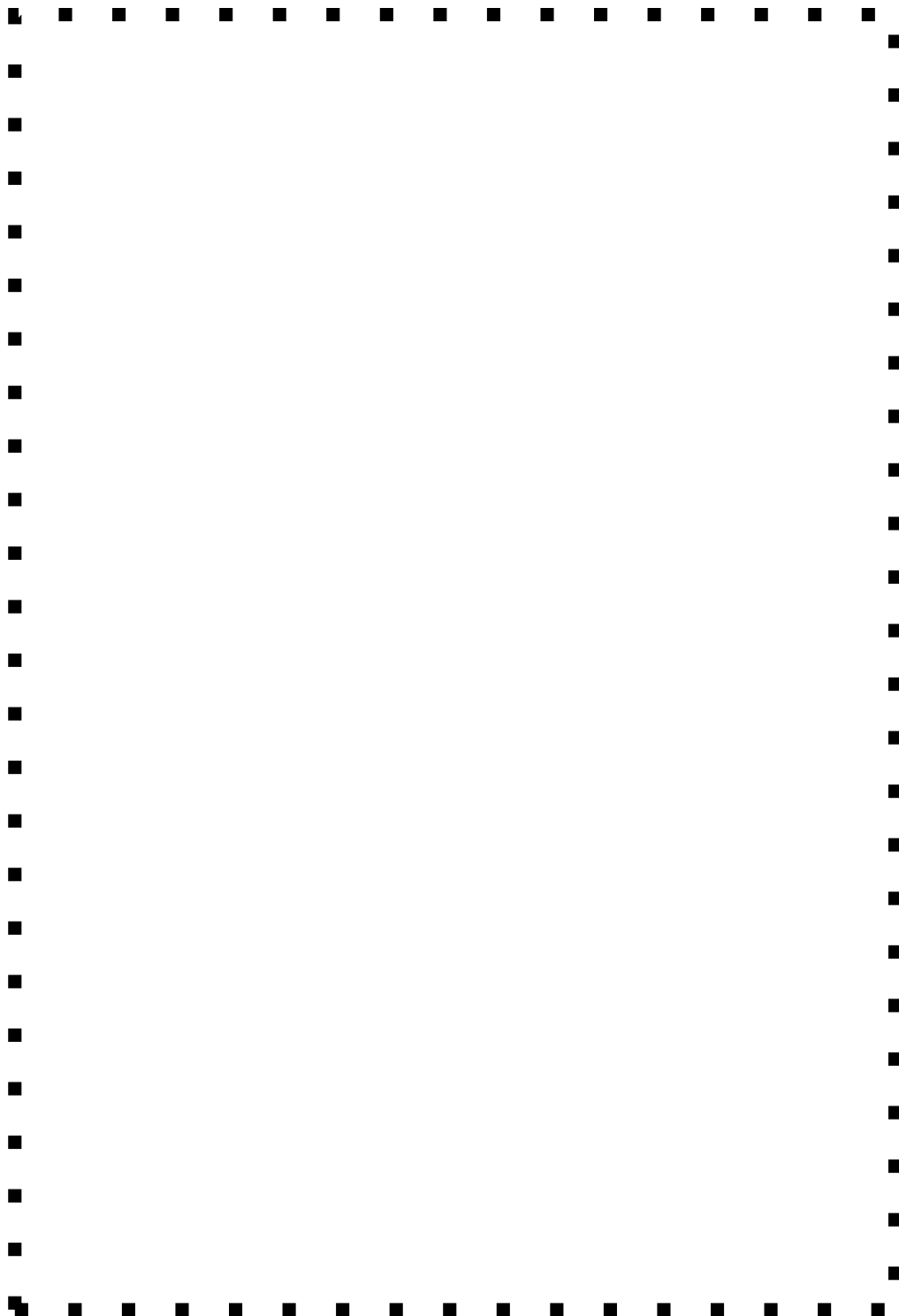

Dibuja siguiendo la línea de puntos la figura geométrica

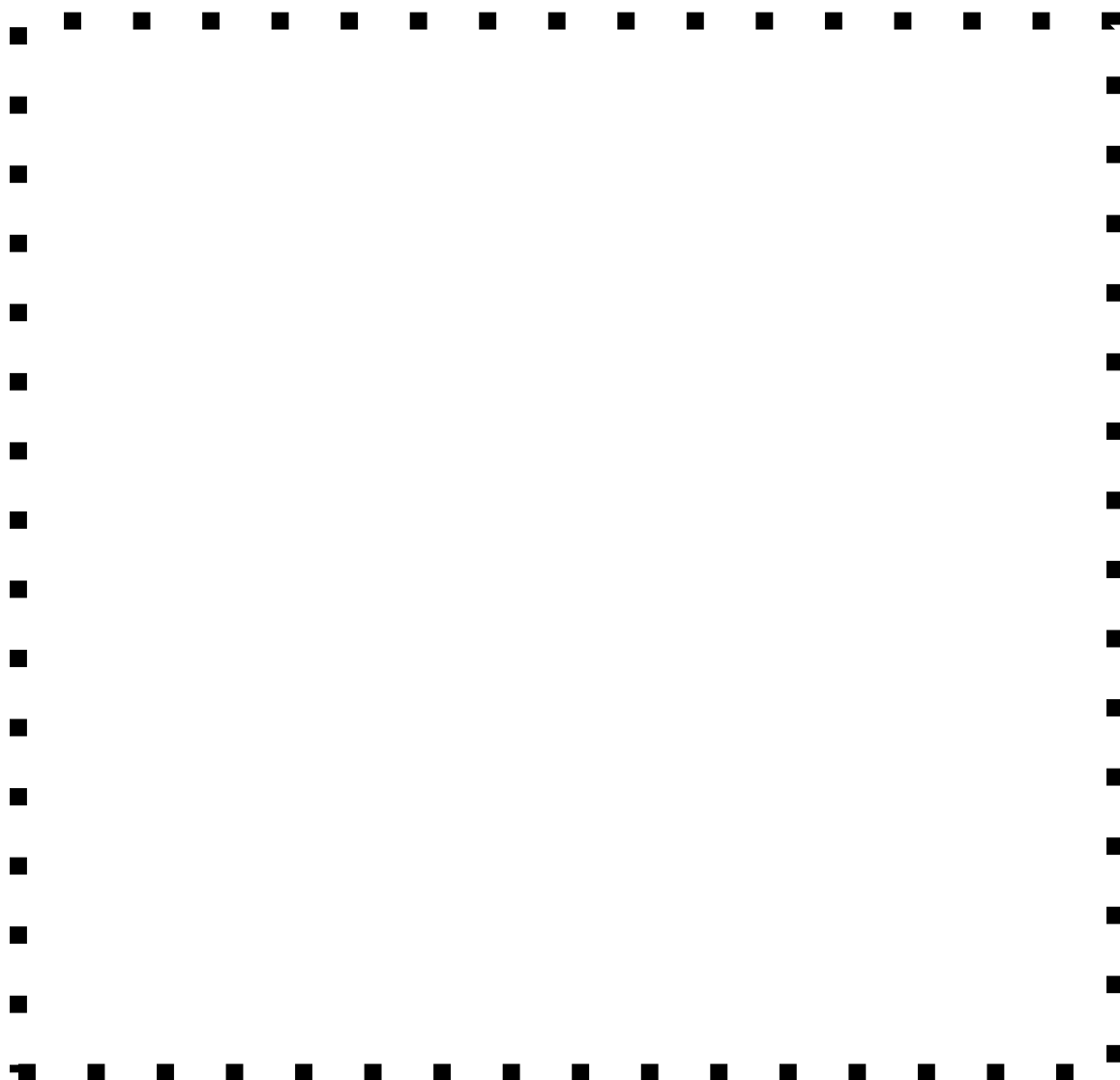

Dibuja siguiendo la línea de puntos la figura geométrica

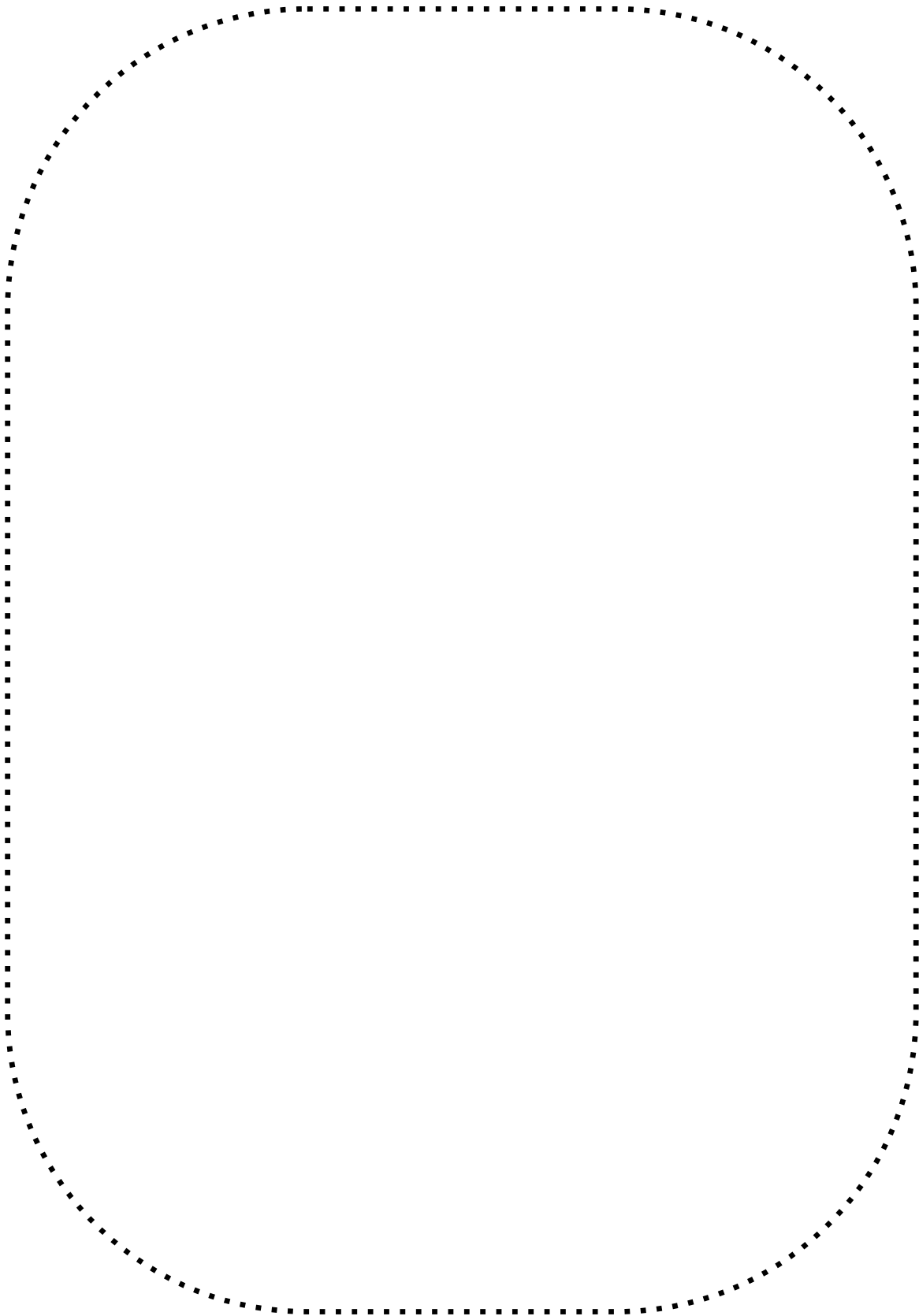

Dibuja siguiendo la línea de puntos la figura geométrica

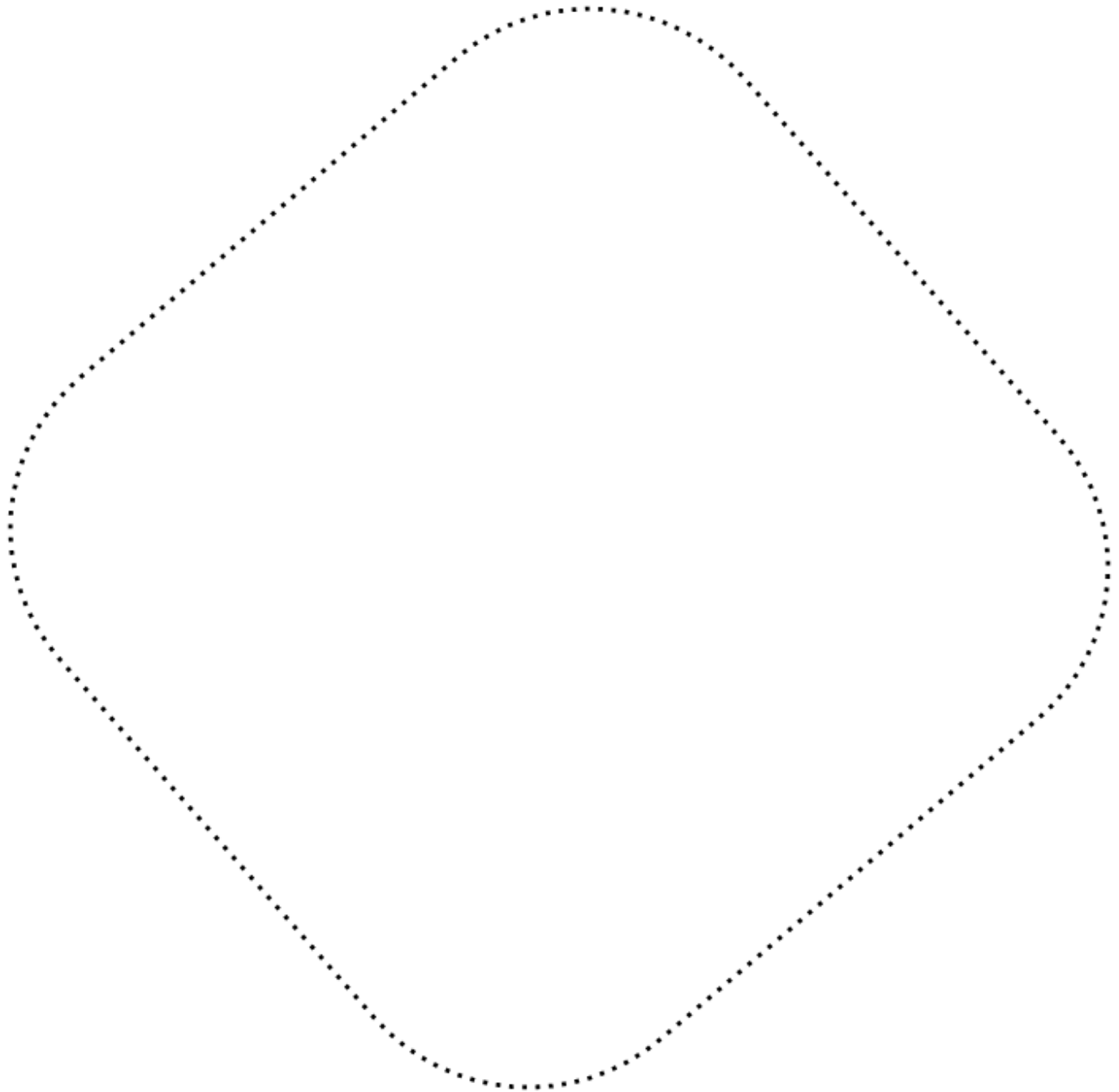

Dibuja siguiendo la línea de puntos la figura geométrica

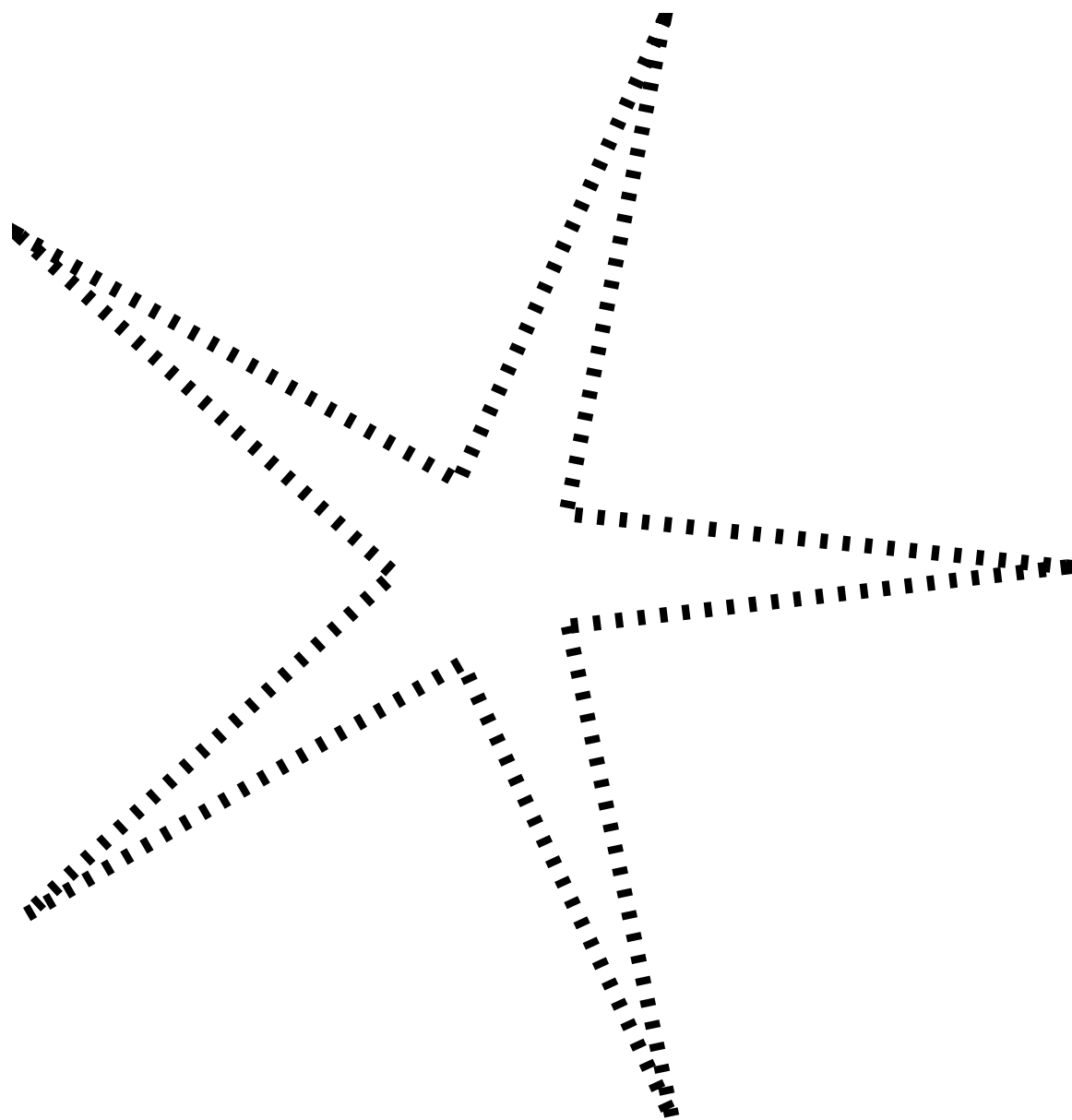

Dibuja siguiendo la línea de puntos la figura geométrica

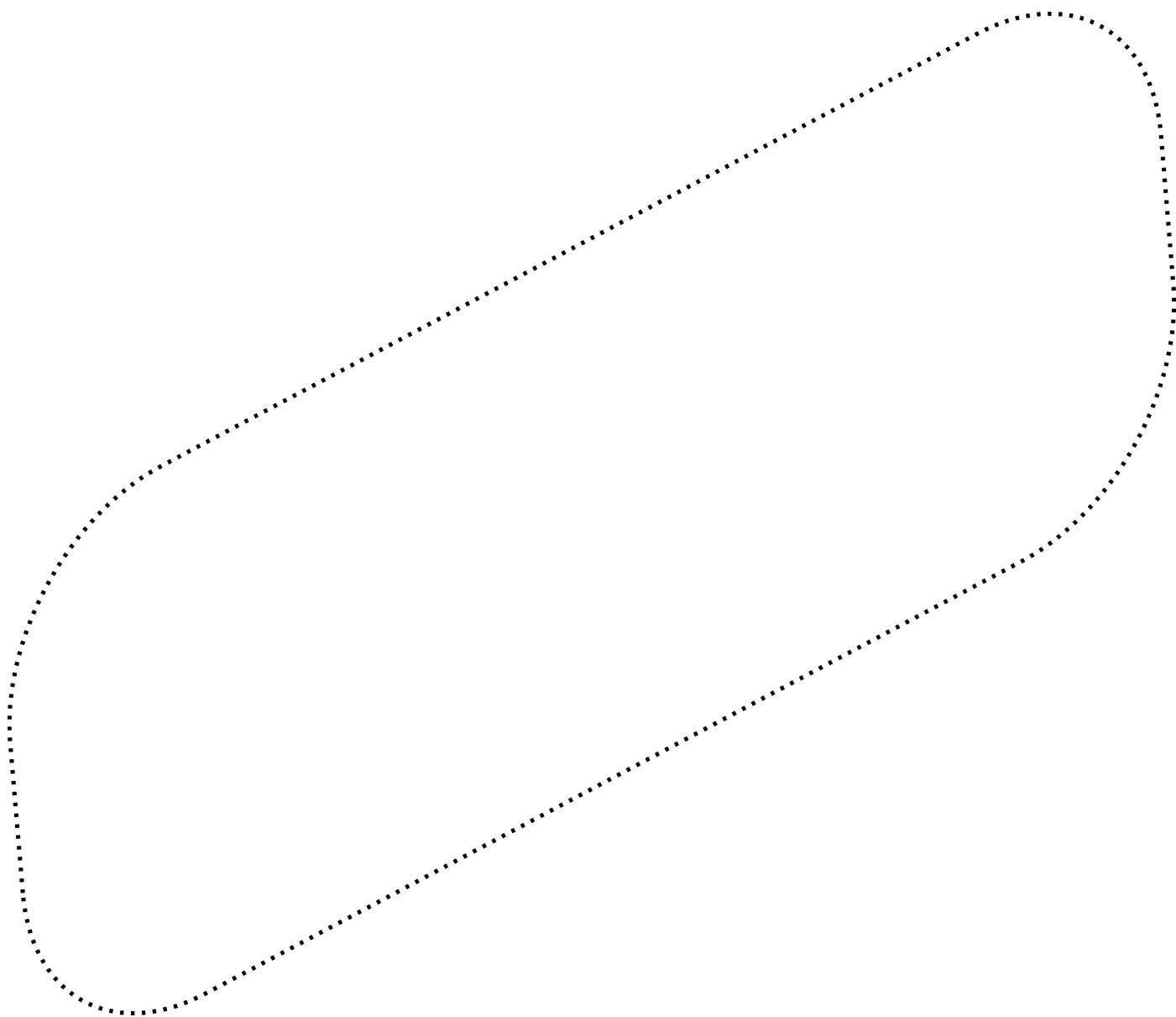

Dibuja siguiendo la línea de puntos la figura geométrica

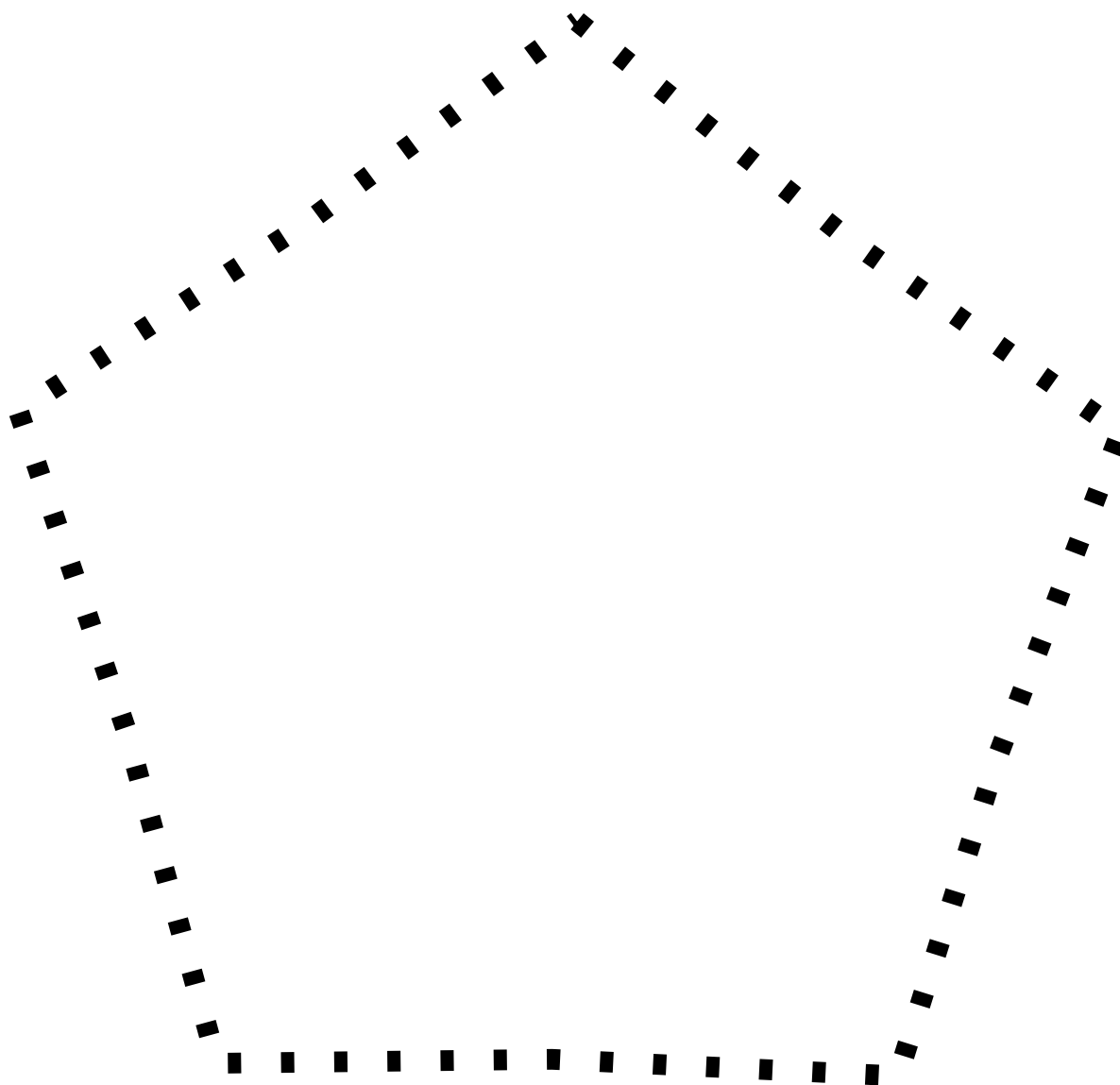

Dibuja siguiendo la línea de puntos la figura geométrica

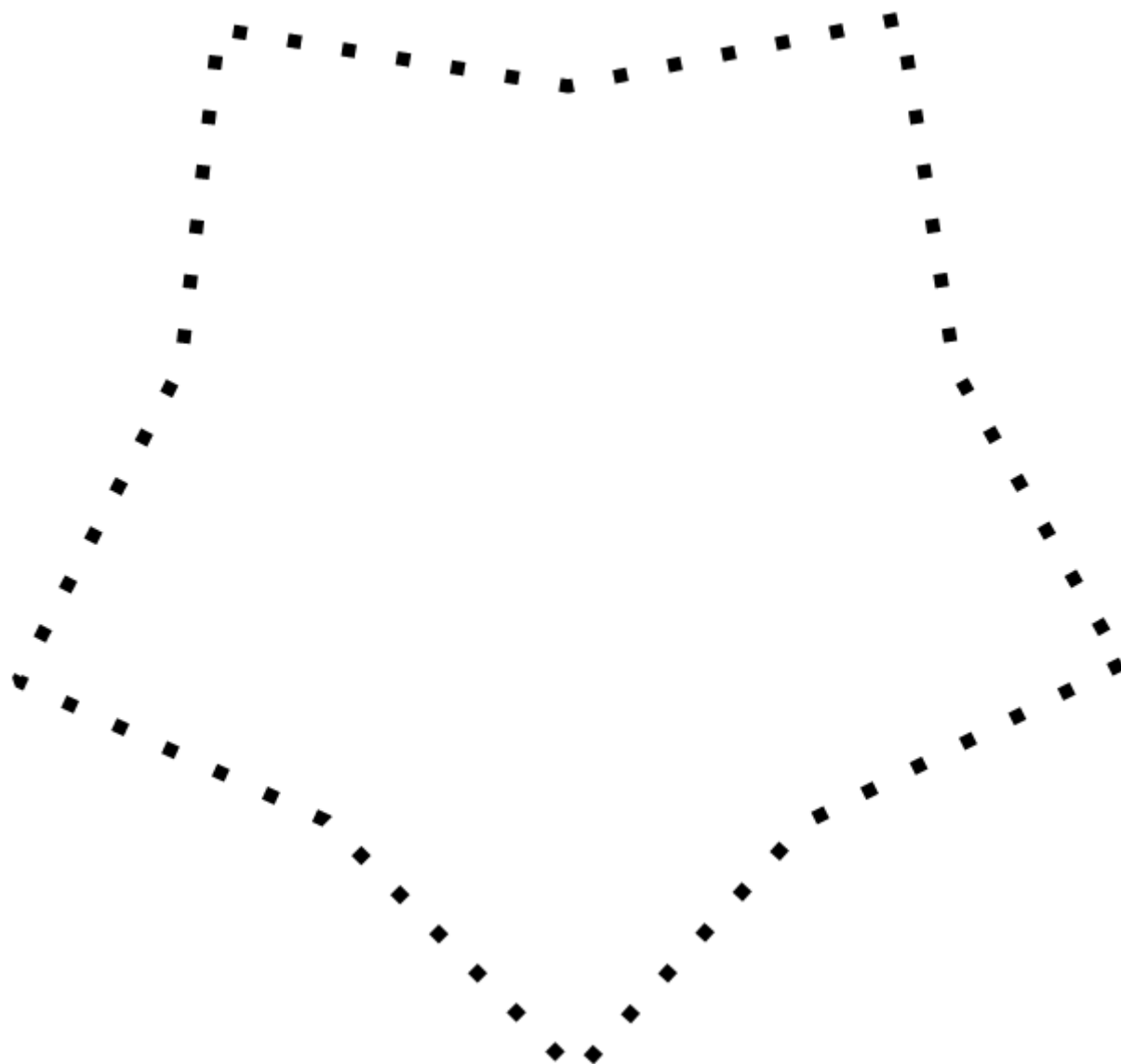

Dibuja siguiendo la línea de puntos la figura geométrica

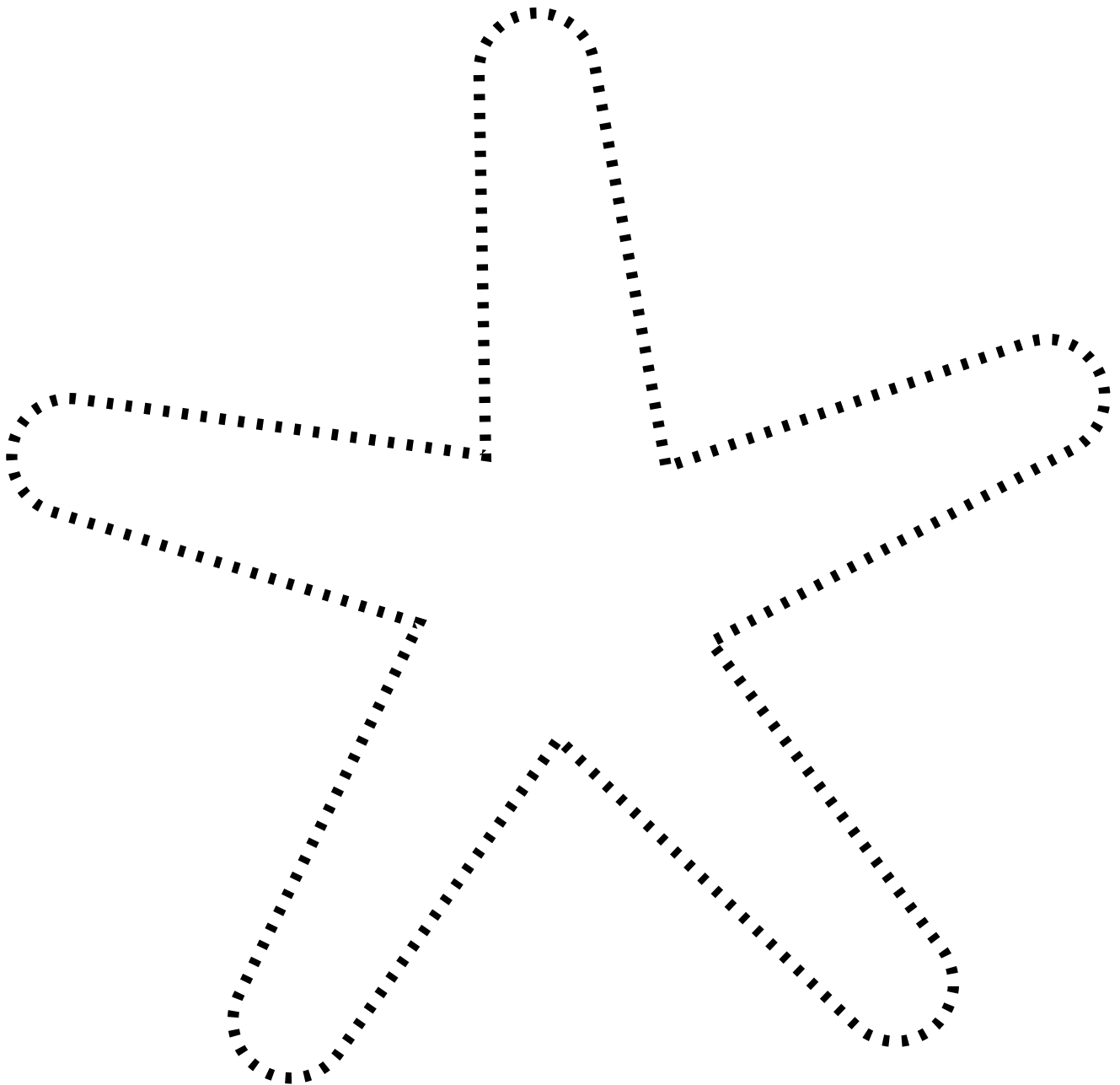

Dibuja siguiendo la línea de puntos la figura geométrica

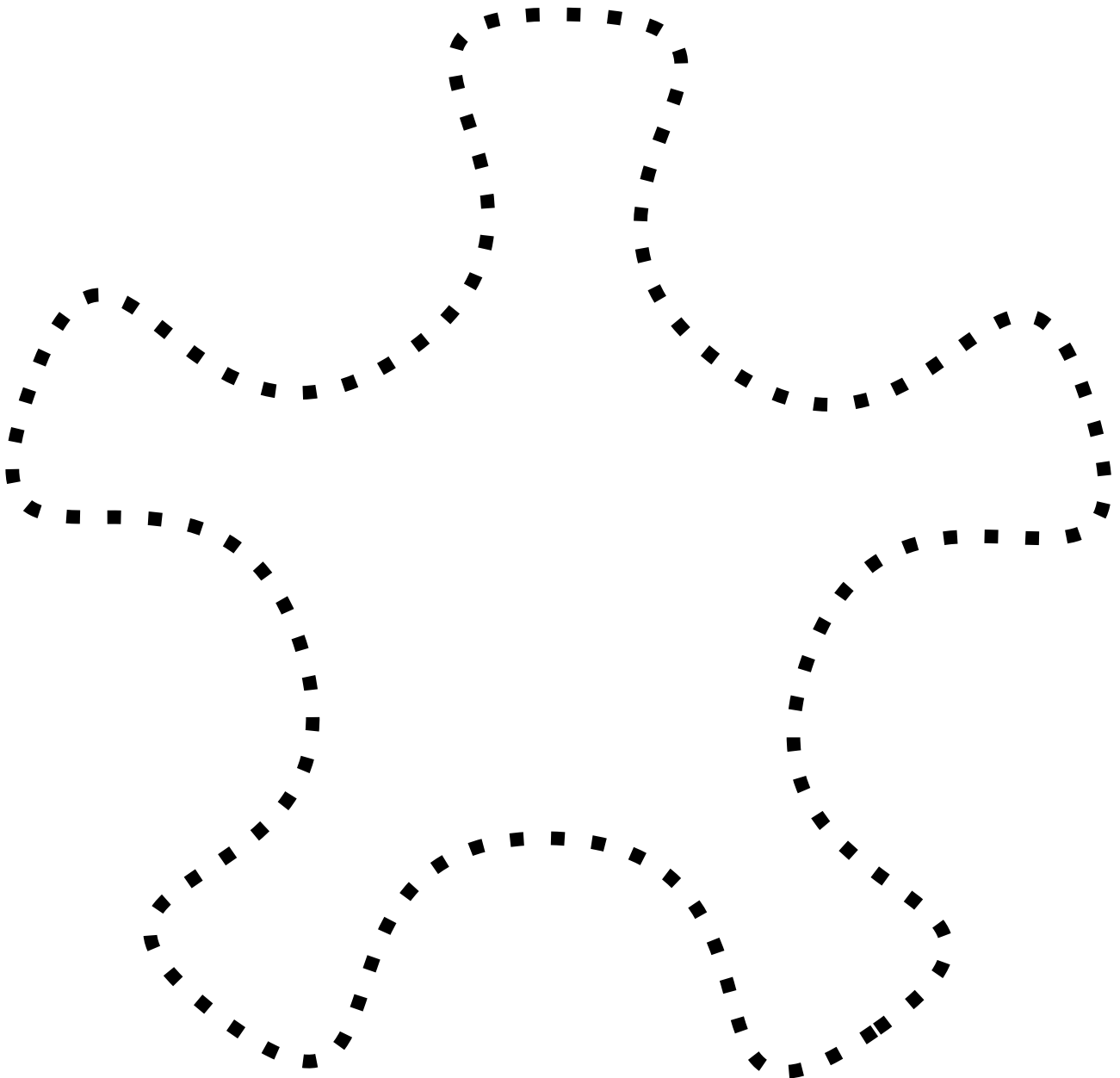

Dibuja siguiendo la línea de puntos la figura geométrica

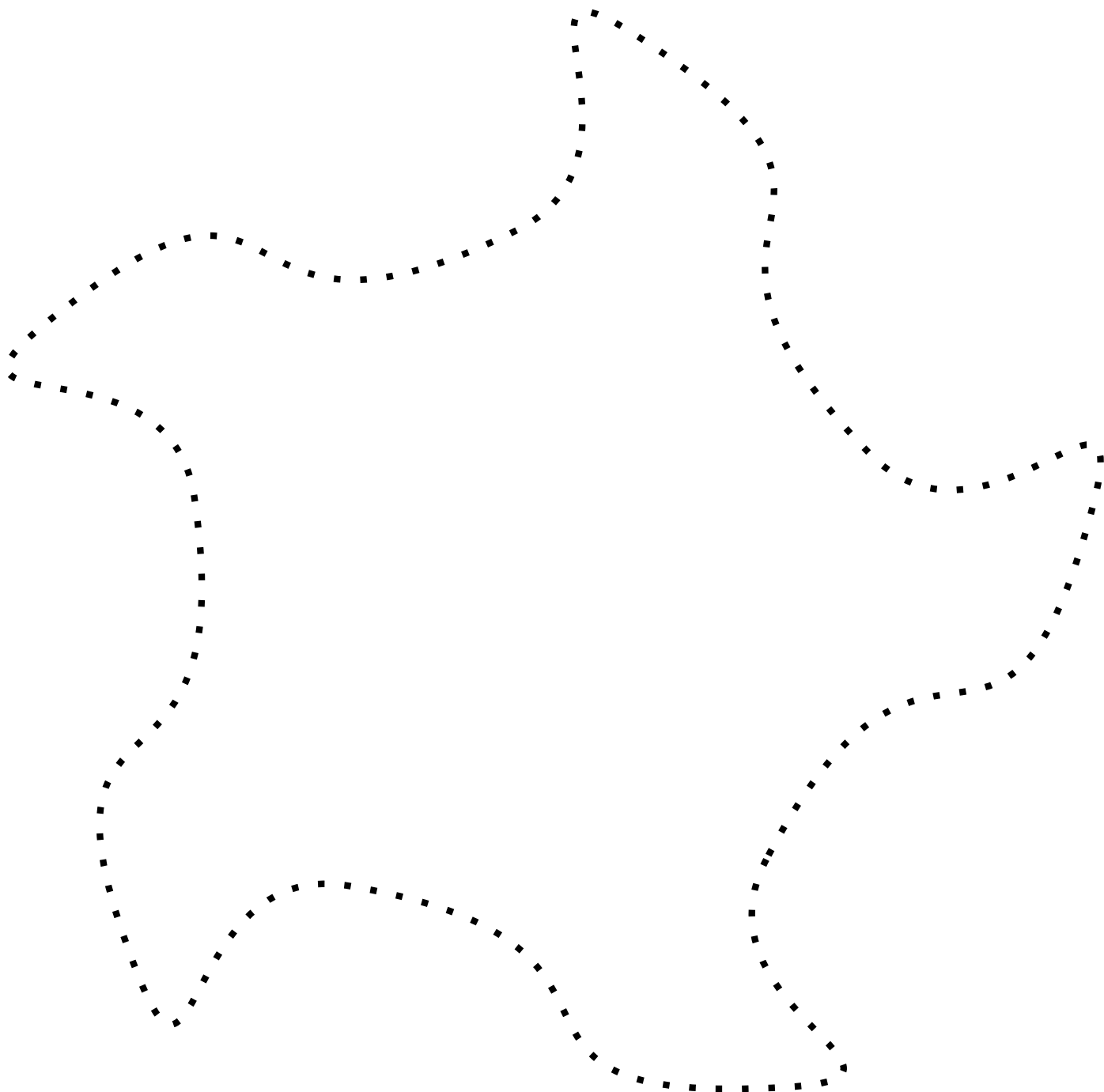

Dibuja siguiendo la línea de puntos la figura geométrica

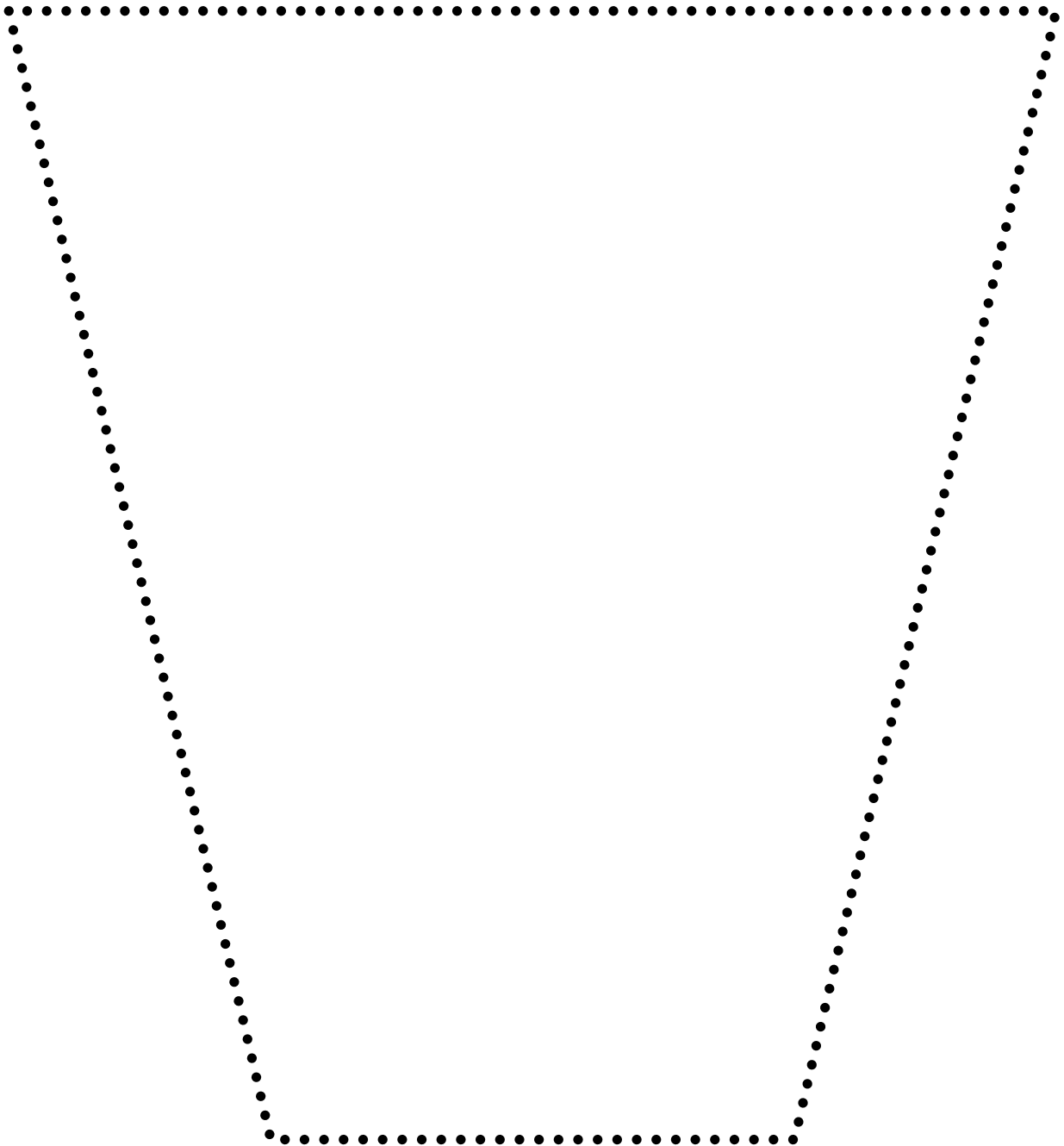

Dibuja siguiendo la línea de puntos la figura geométrica

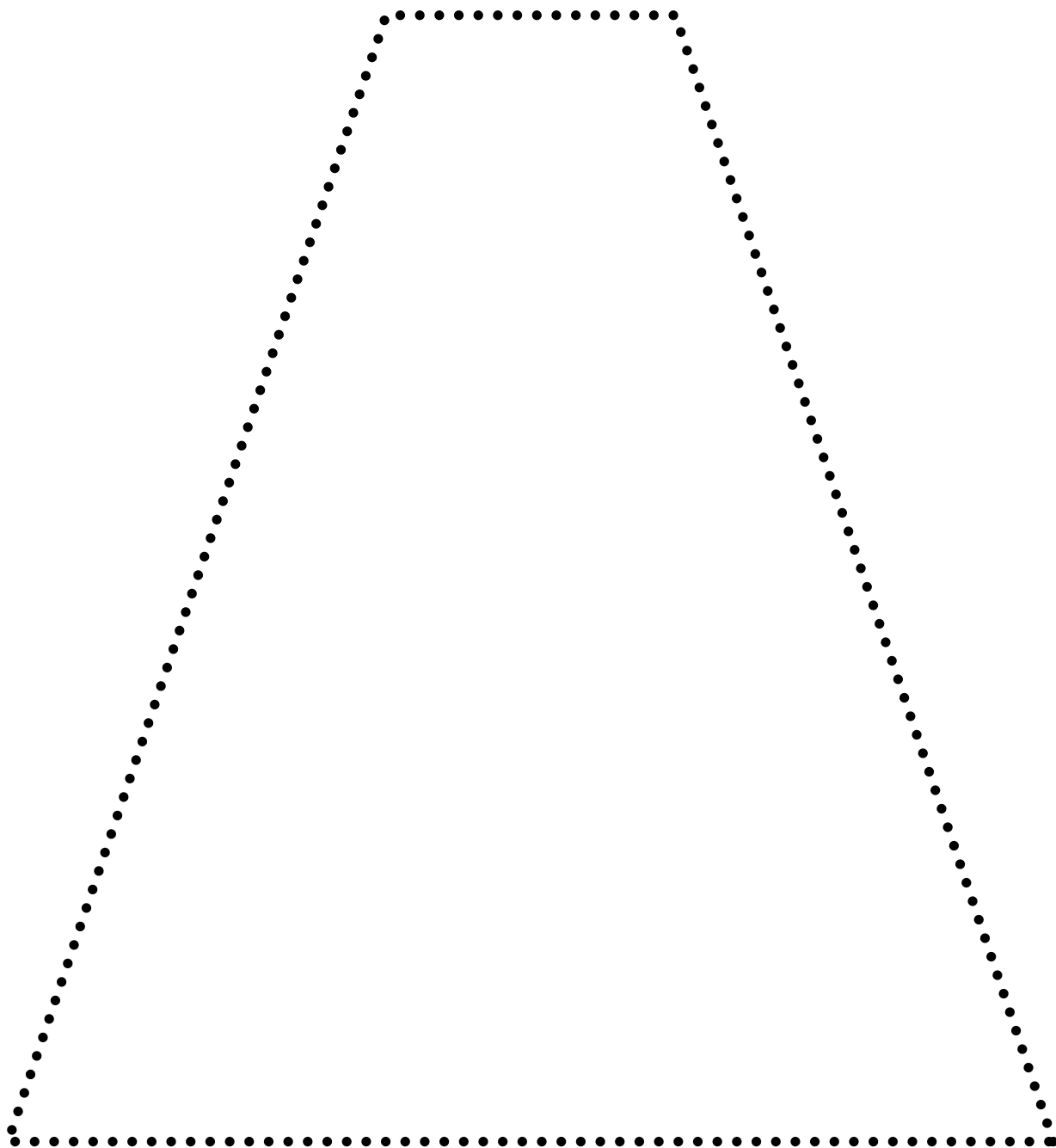

Dibuja siguiendo la línea de puntos la figura geométrica

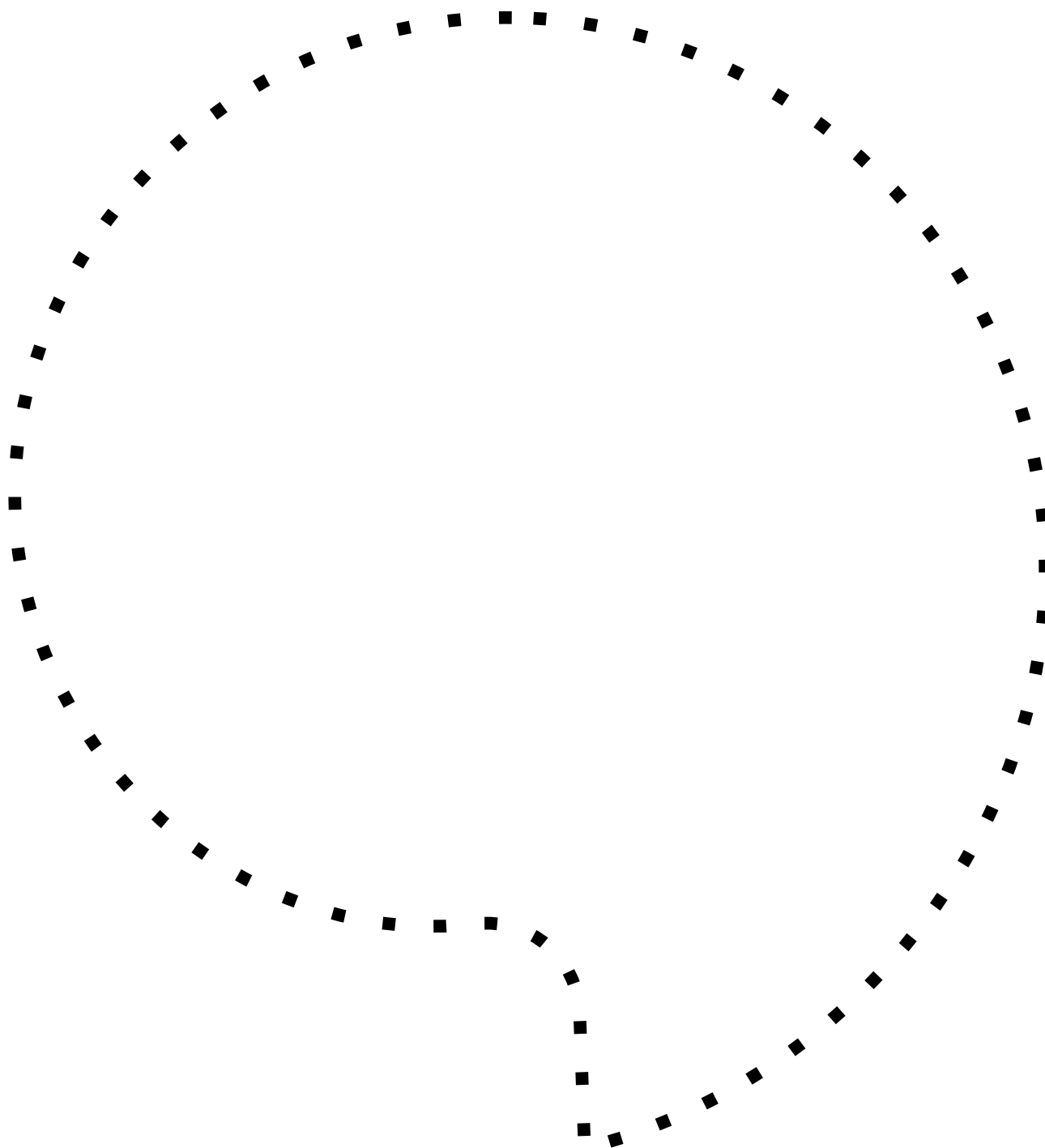

Dibuja siguiendo la línea de puntos la figura geométrica

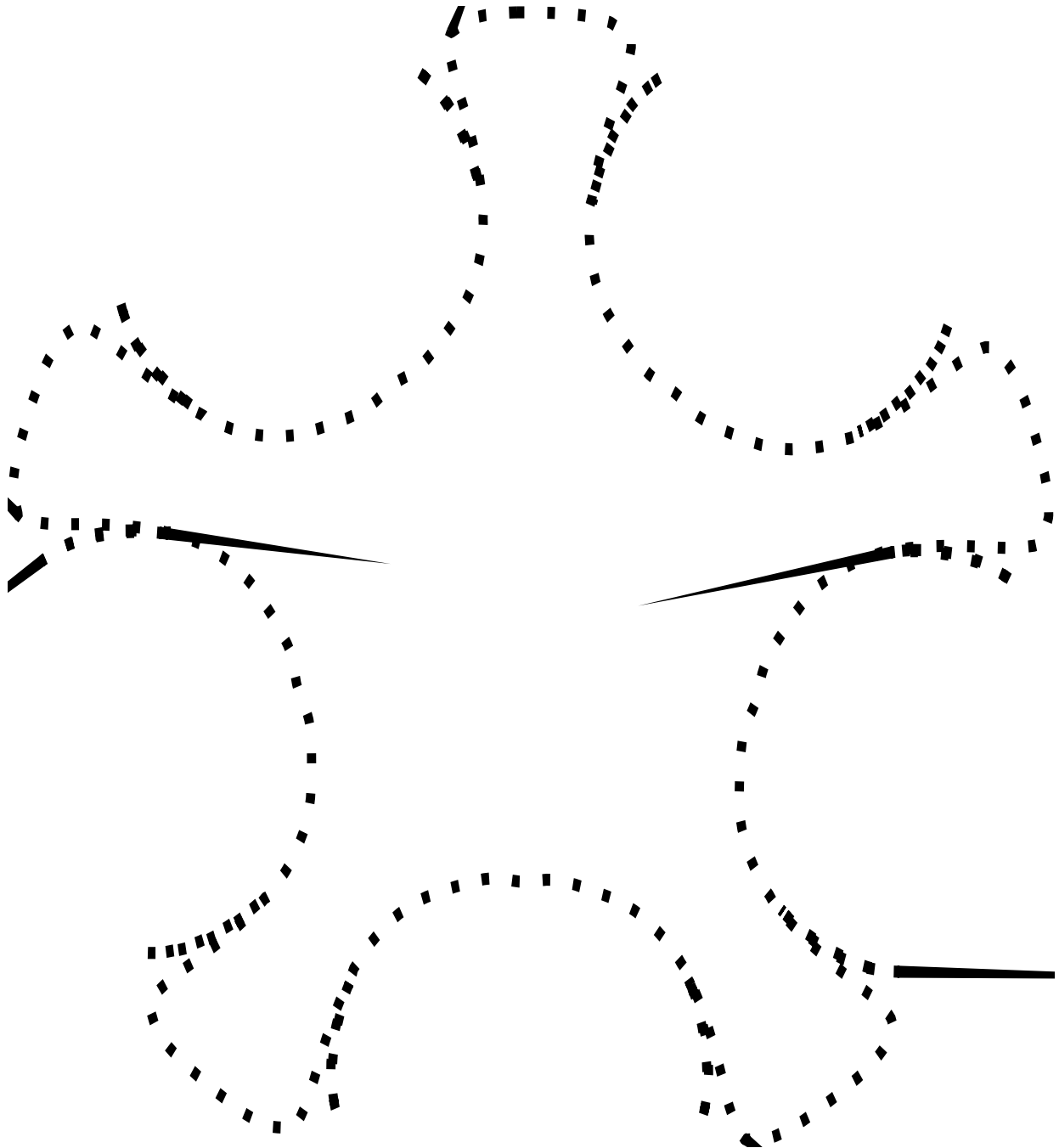

Dibuja siguiendo la línea de puntos la figura geométrica

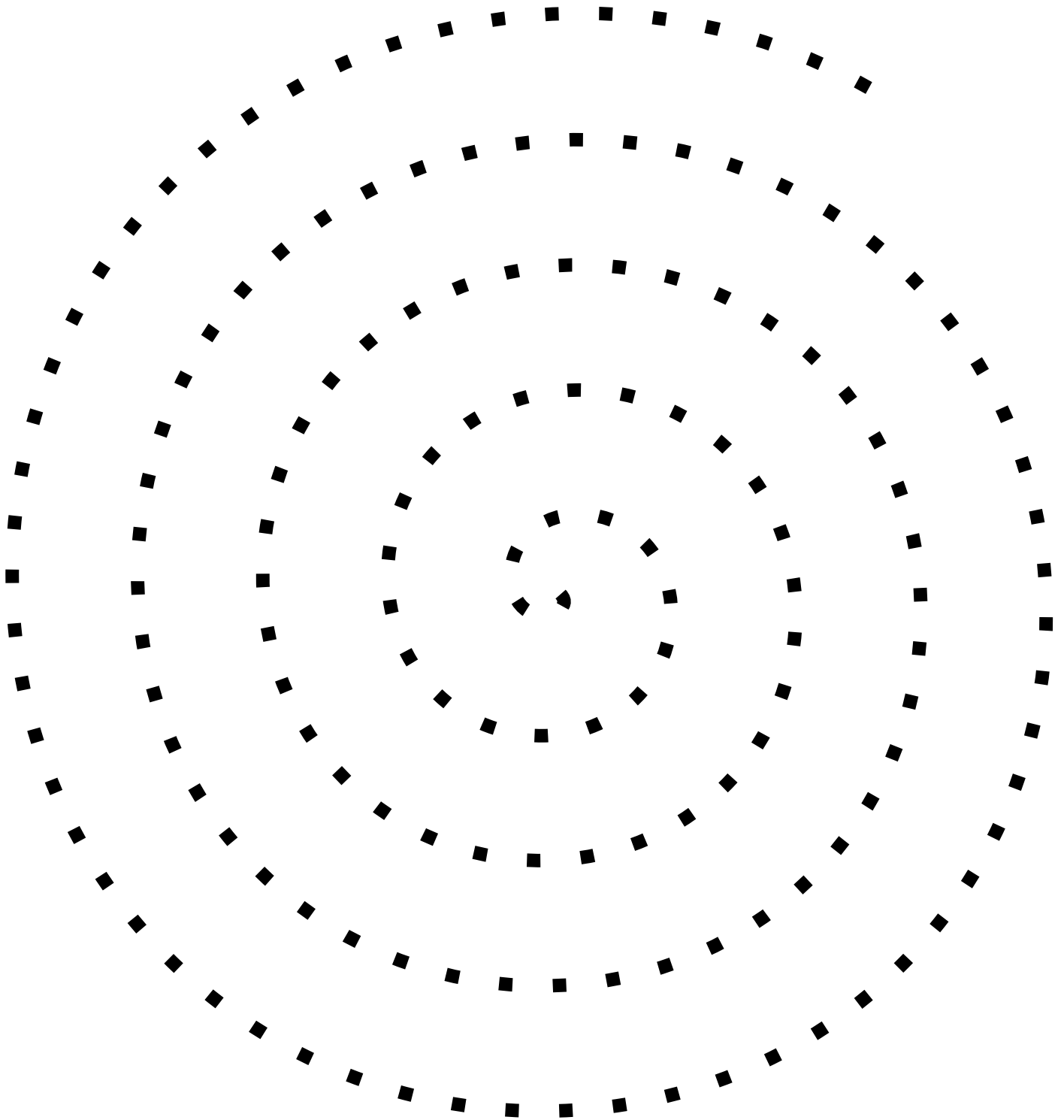

Dibuja siguiendo la línea de puntos la figura geométrica

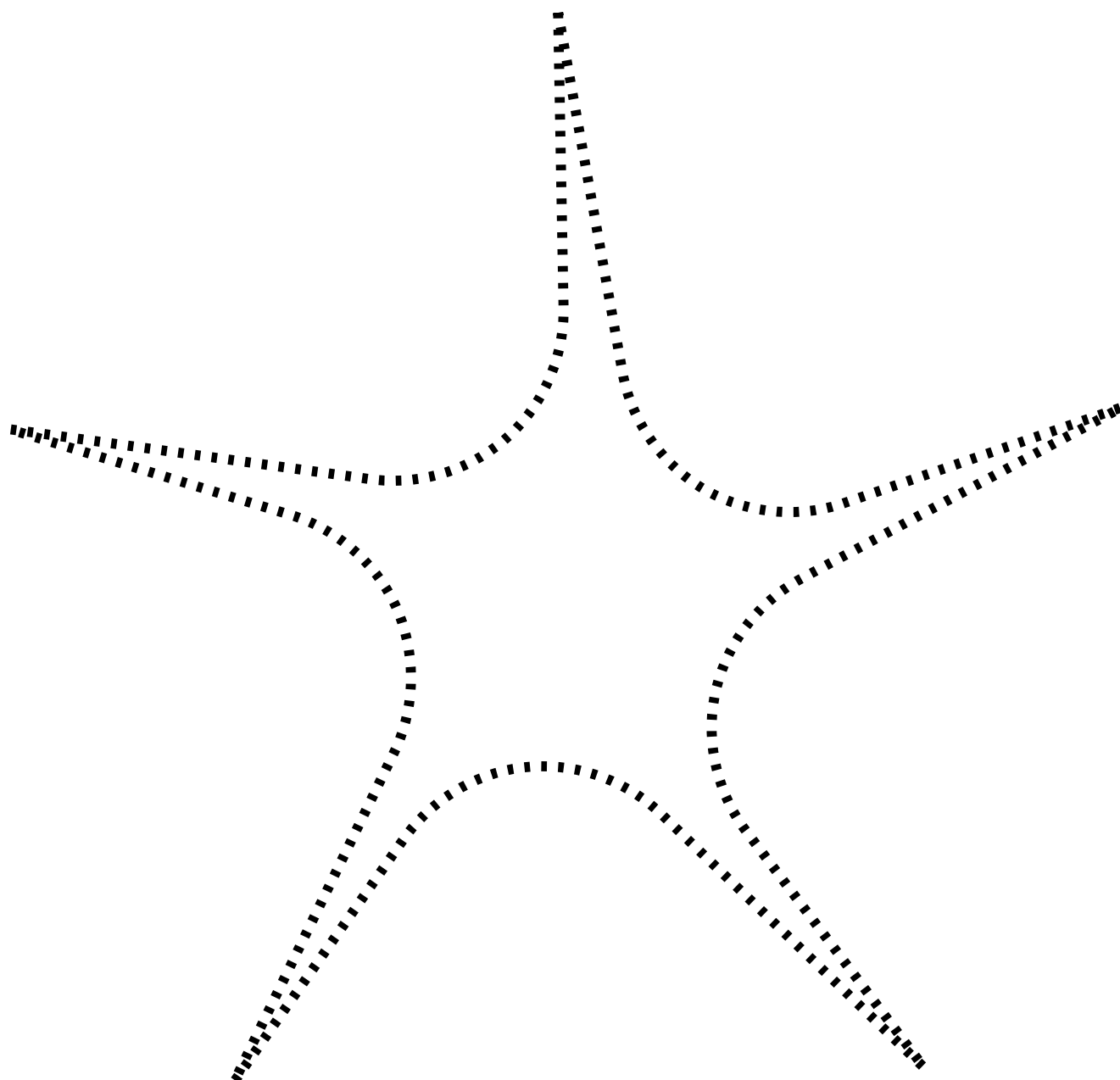

Dibuja siguiendo la línea de puntos la figura geométrica

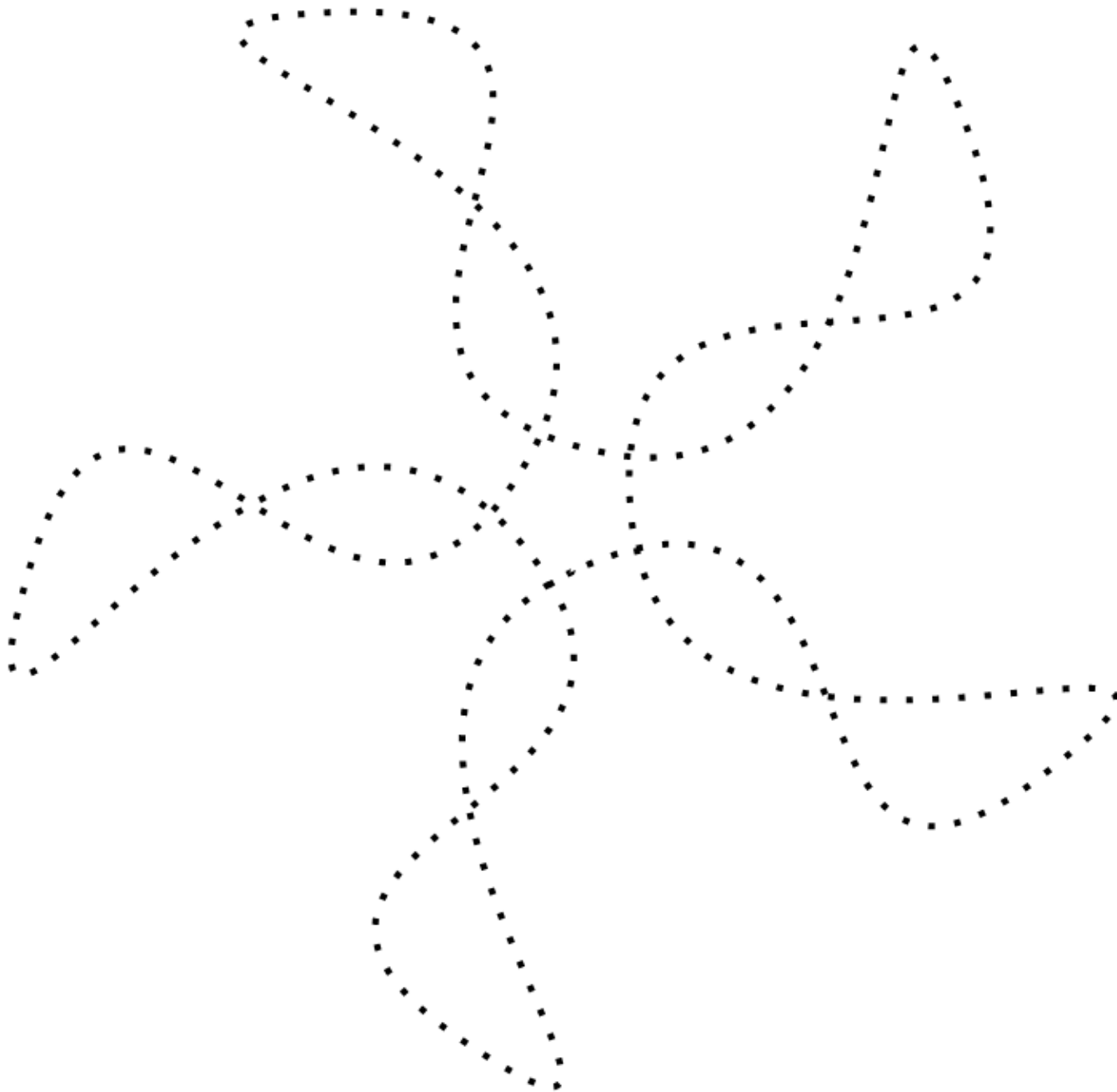

Dibuja siguiendo la línea de puntos la figura geométrica

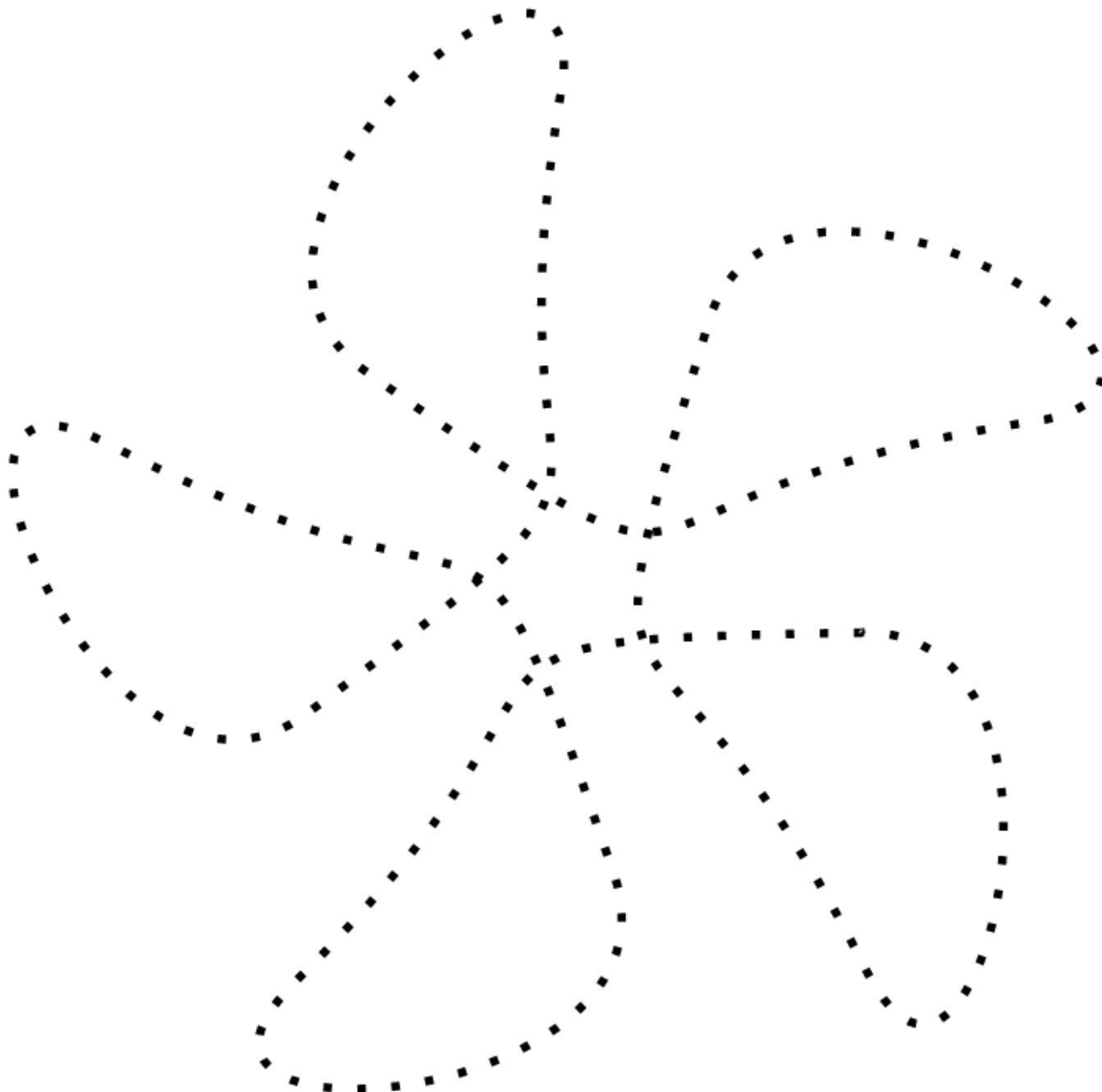

Dibuja siguiendo la línea de puntos la figura geométrica

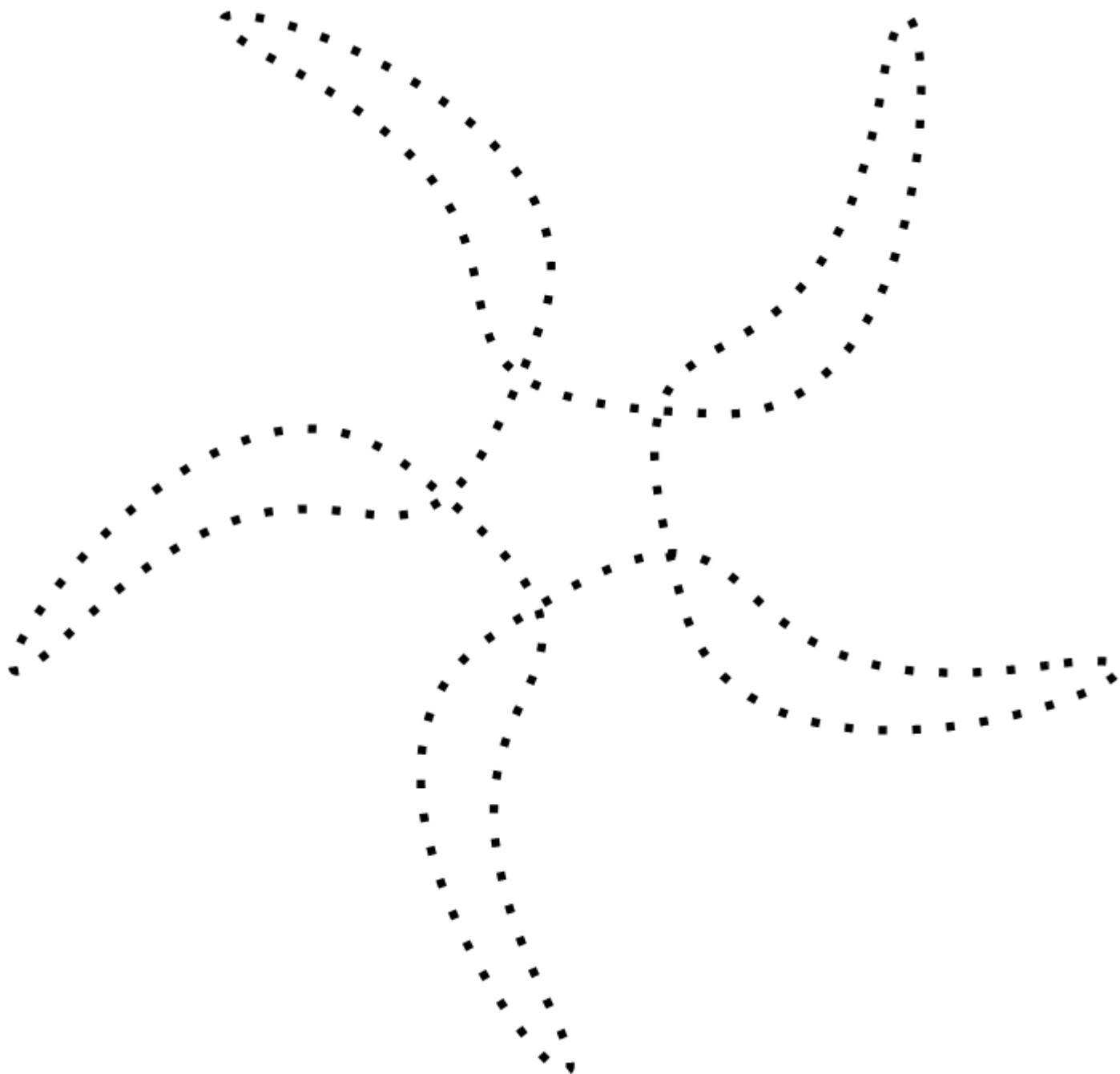

Dibuja siguiendo la línea de puntos la figura geométrica

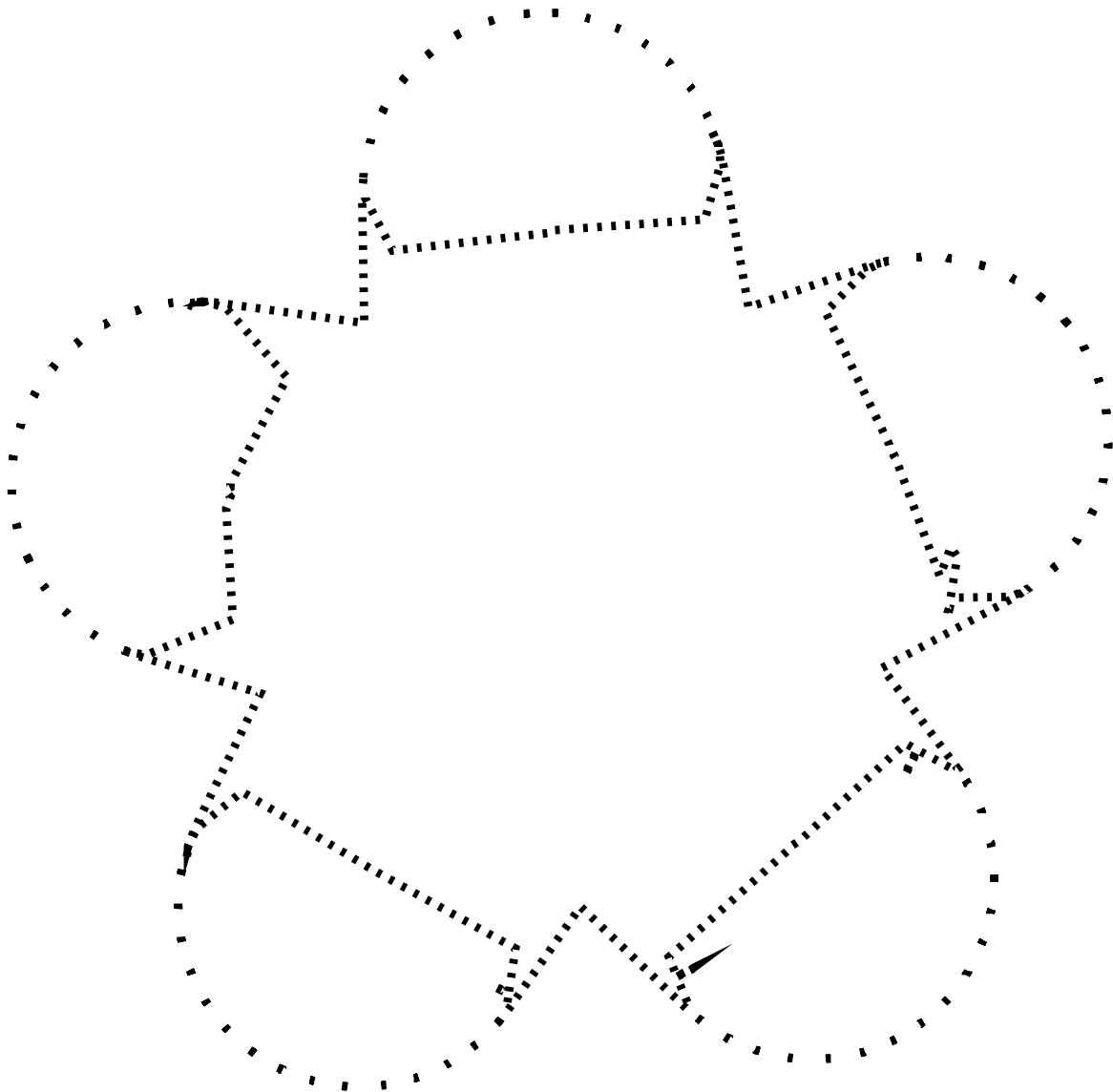

Dibuja siguiendo la línea de puntos la figura geométrica

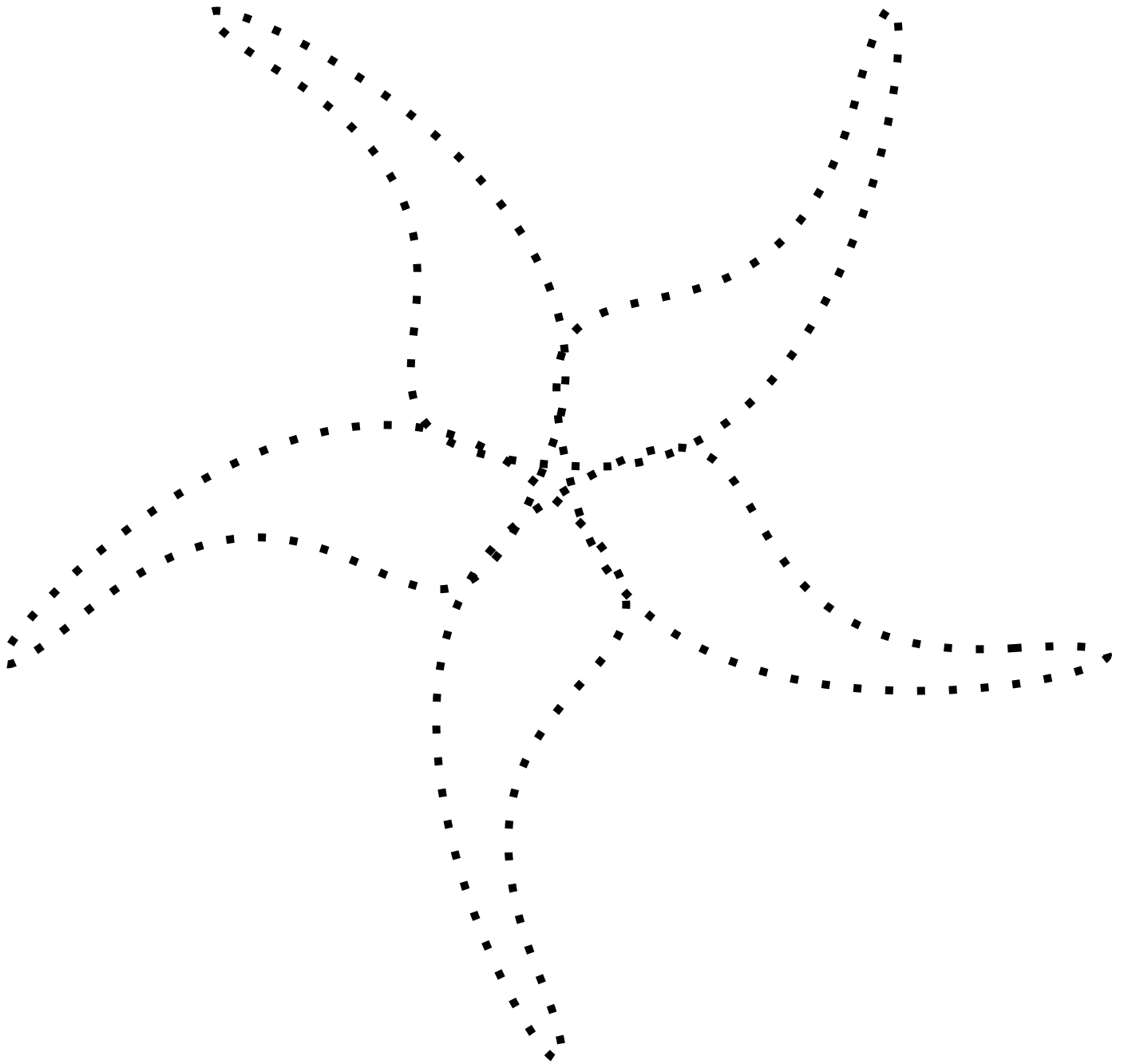

Dibuja siguiendo la línea de puntos la figura geométrica

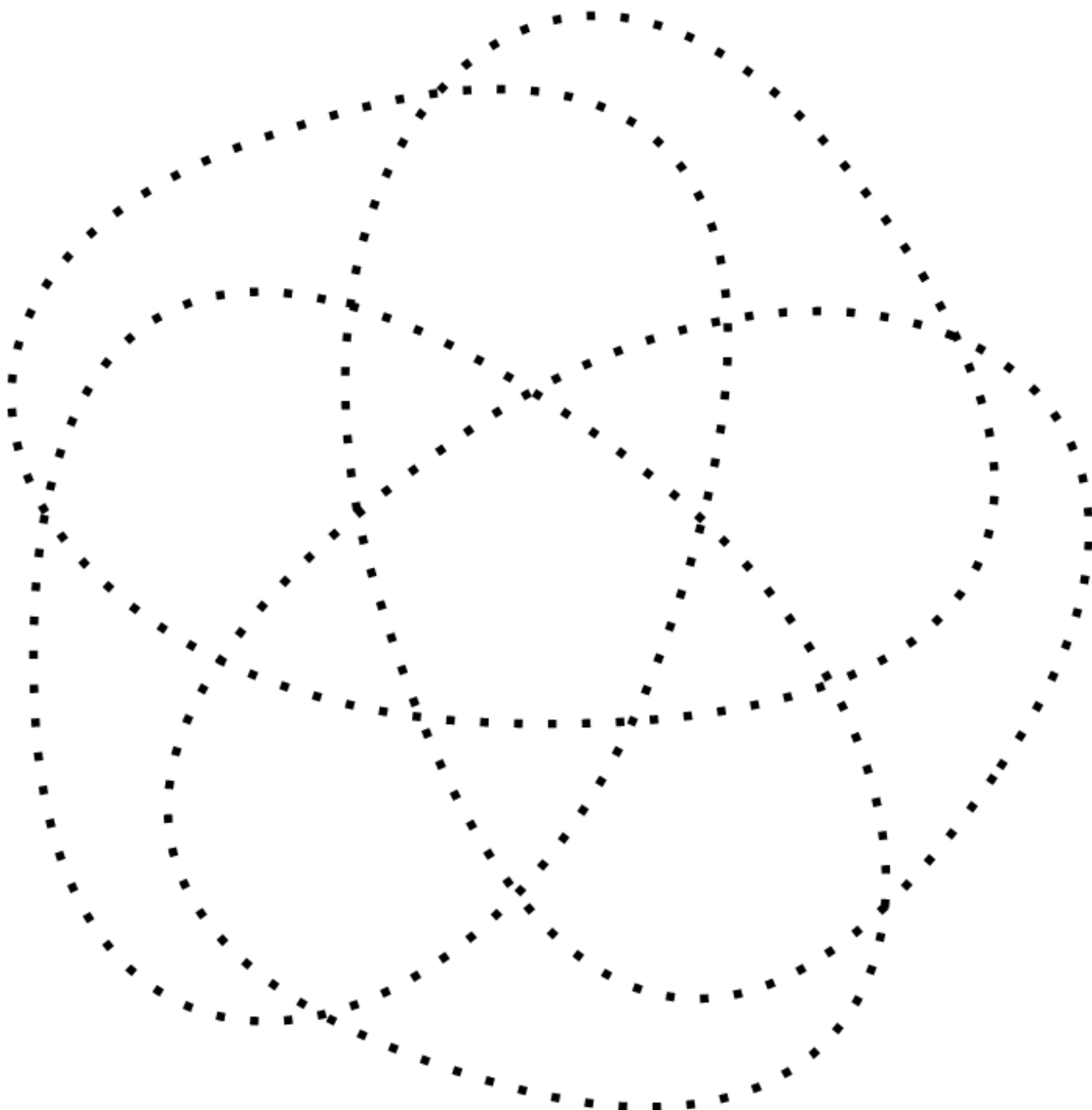

Dibuja siguiendo la línea de puntos la figura geométrica

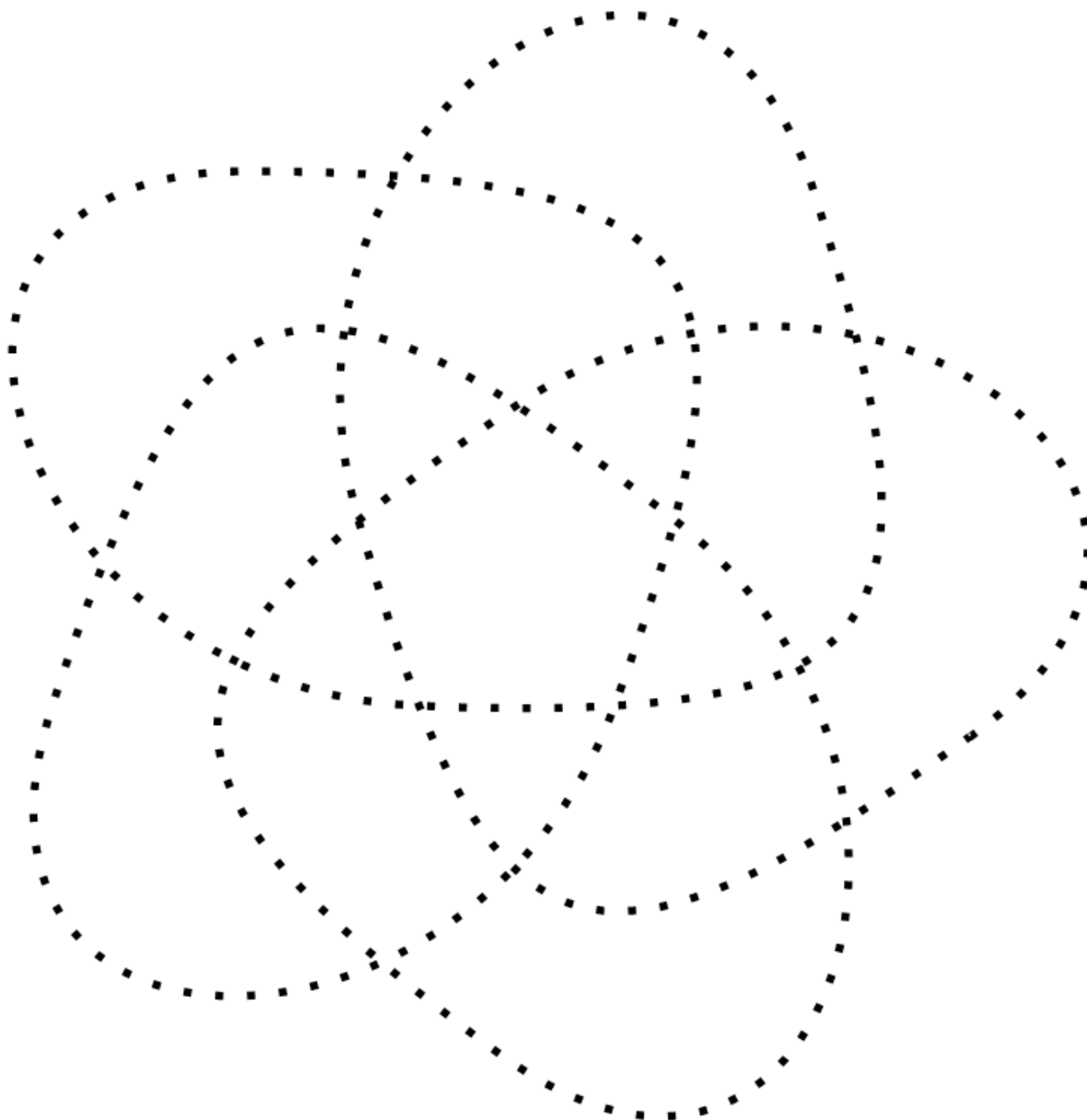

Dibuja siguiendo la línea de puntos la figura geométrica

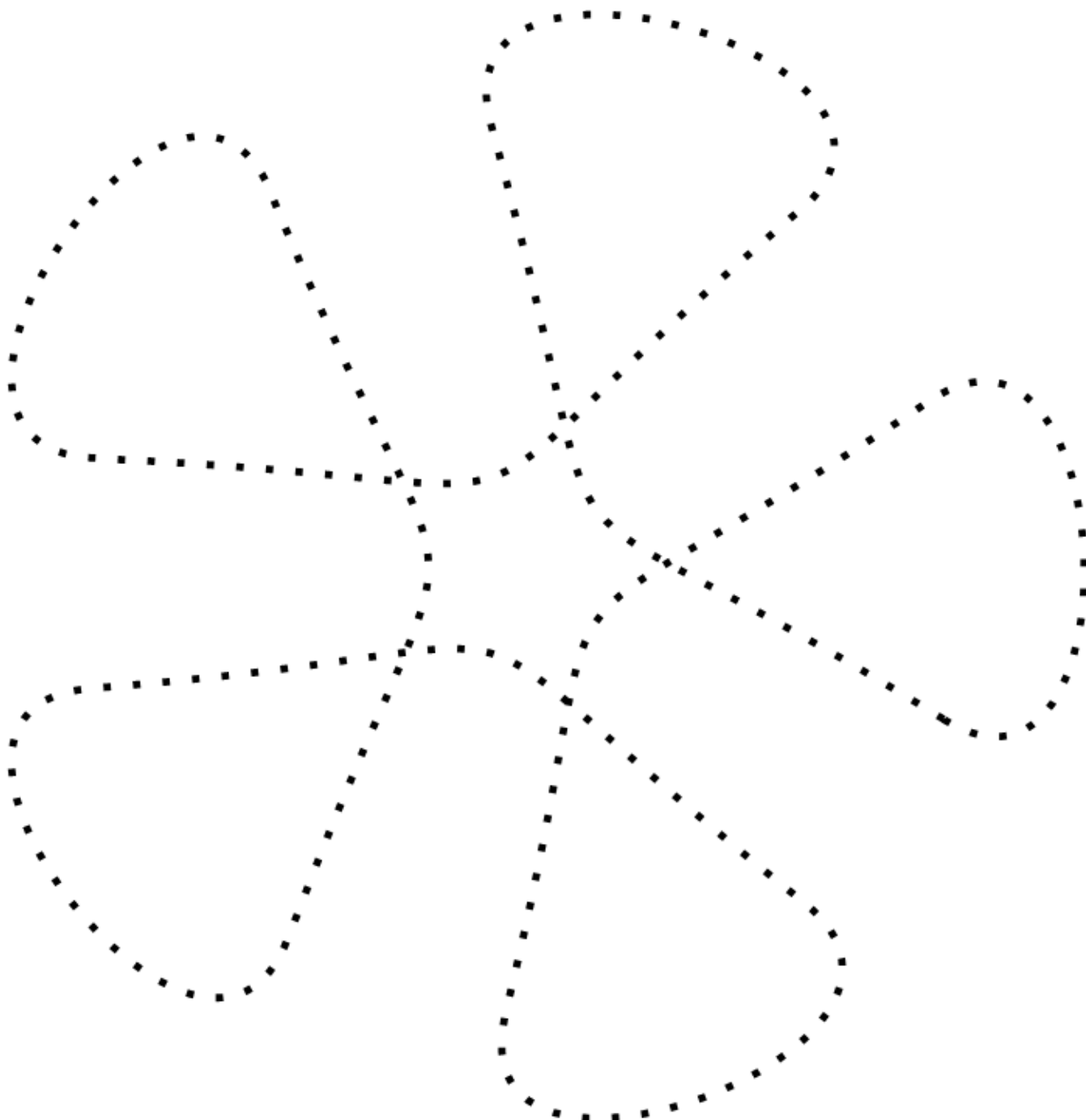

Dibuja siguiendo la línea de puntos la figura geométrica

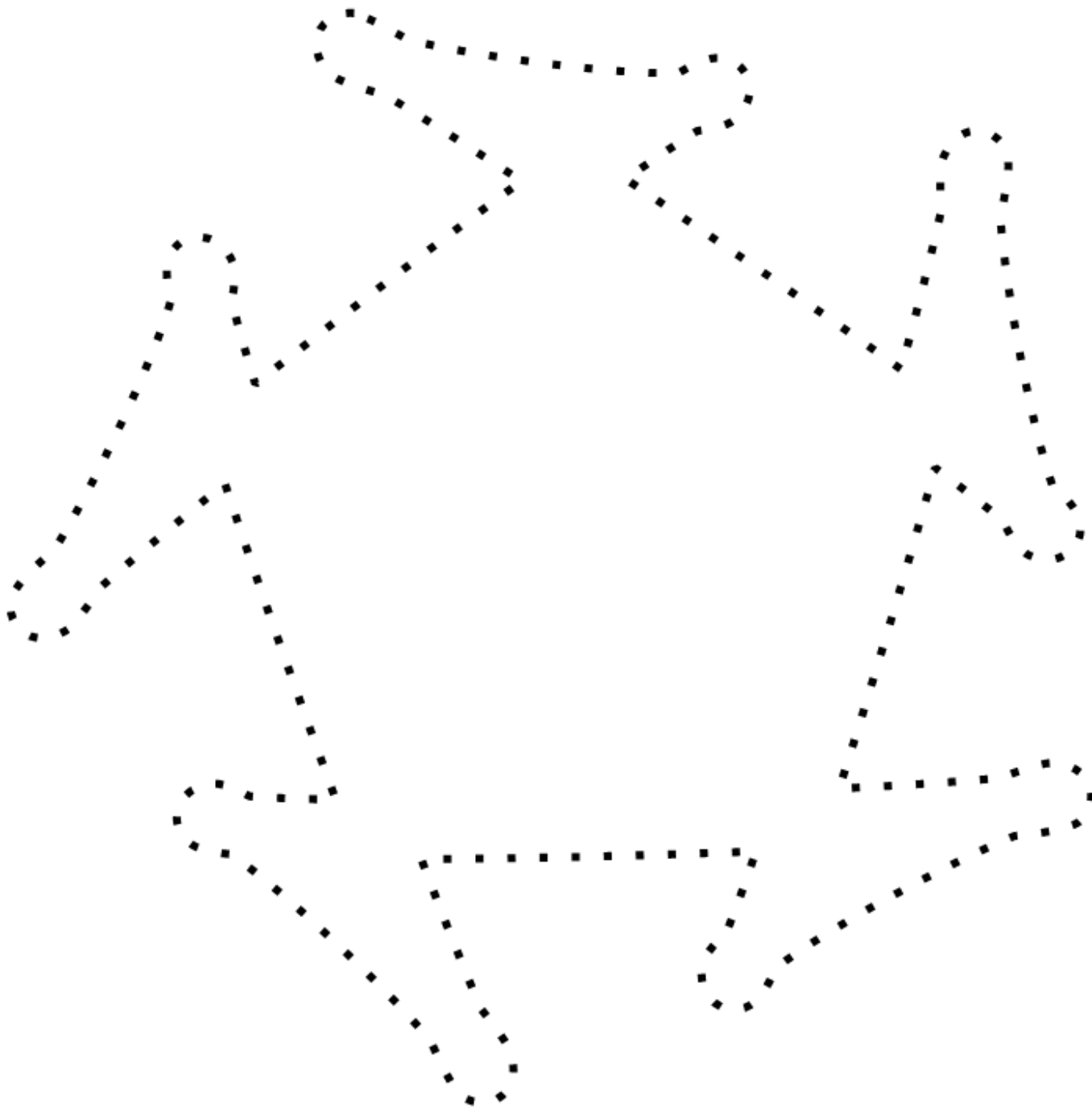

Dibuja siguiendo la línea de puntos la figura geométrica

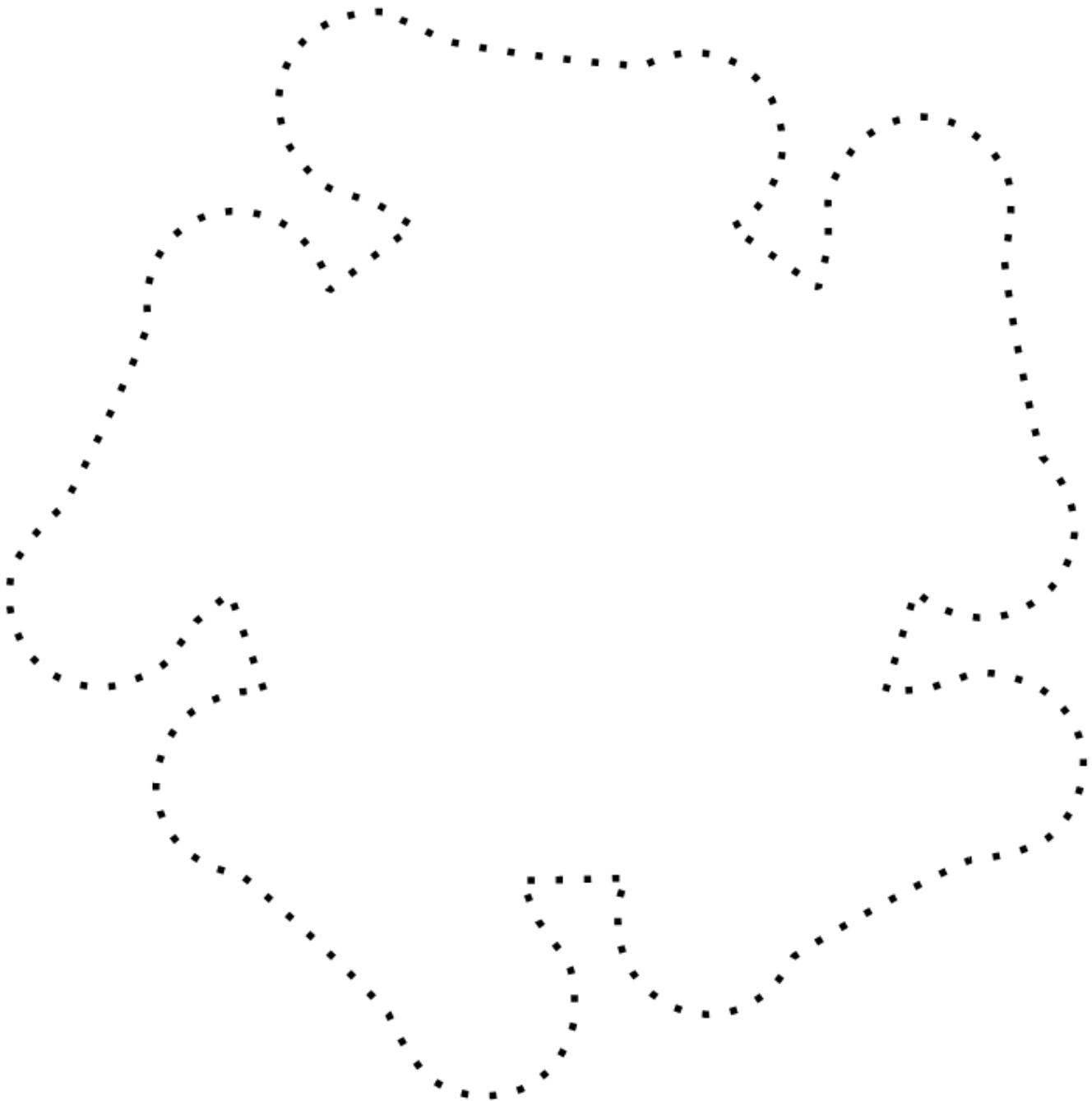

Dibuja siguiendo la línea de puntos la figura geométrica

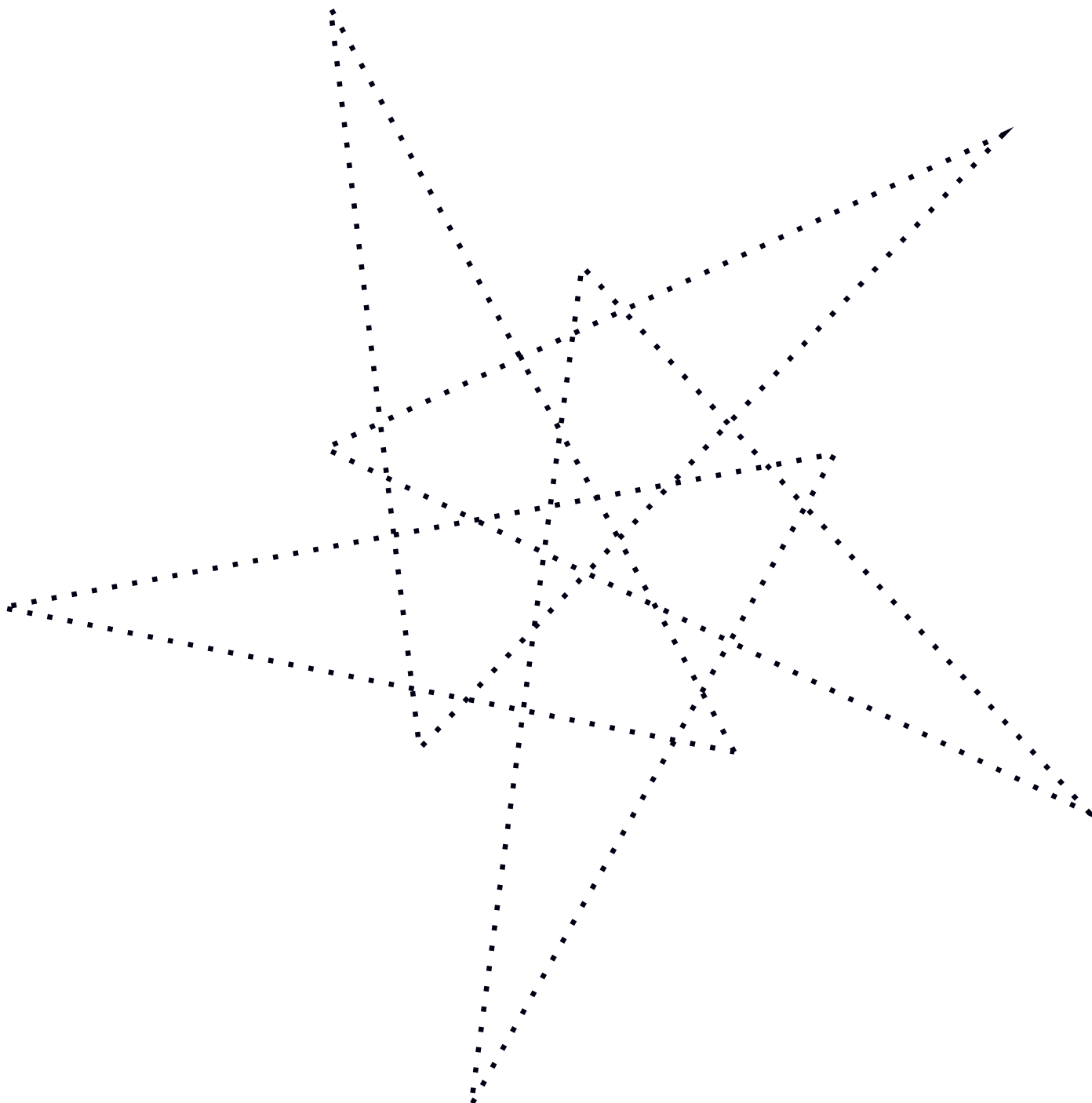

Dibuja siguiendo la línea de puntos la figura geométrica

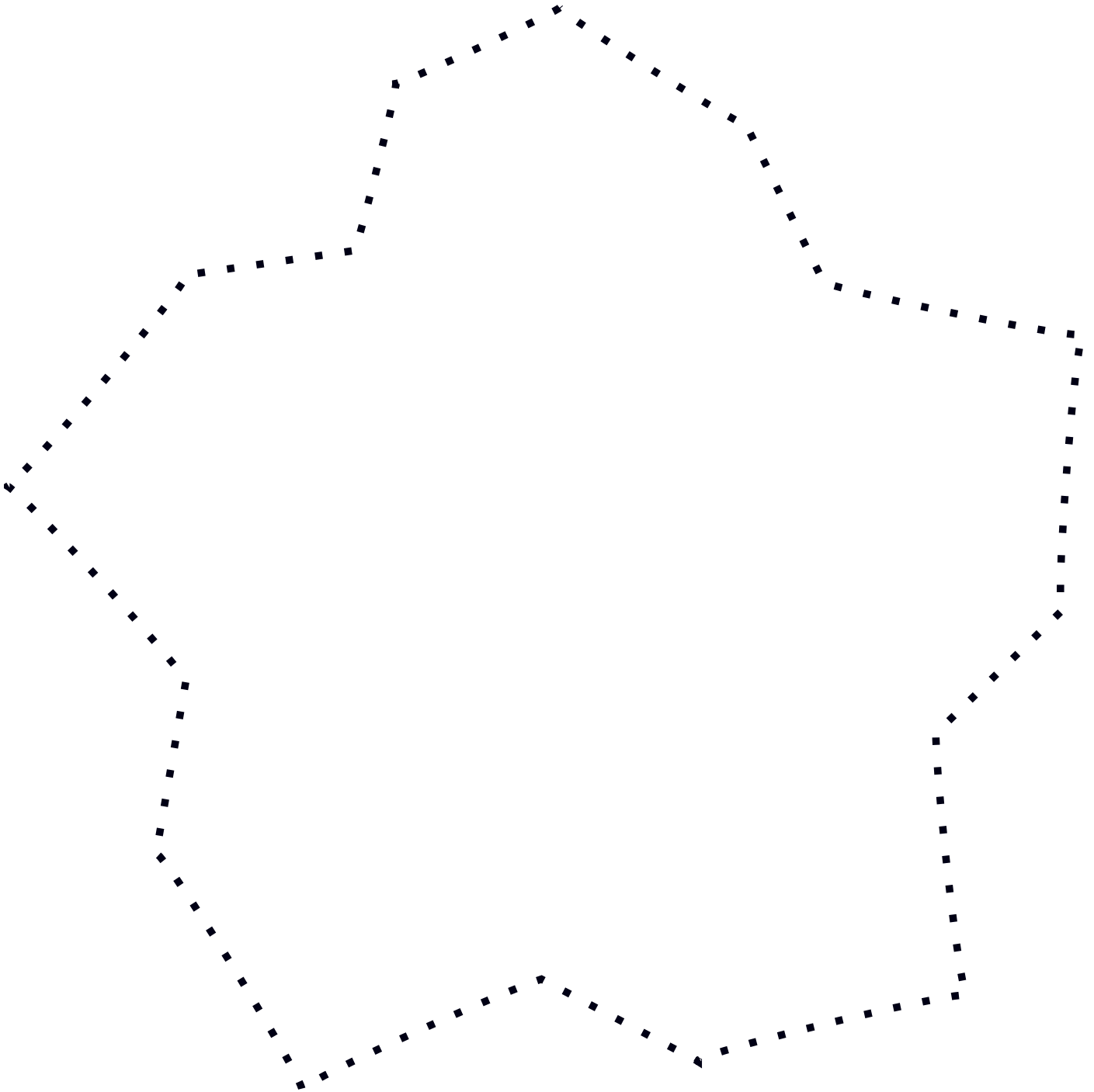

gota

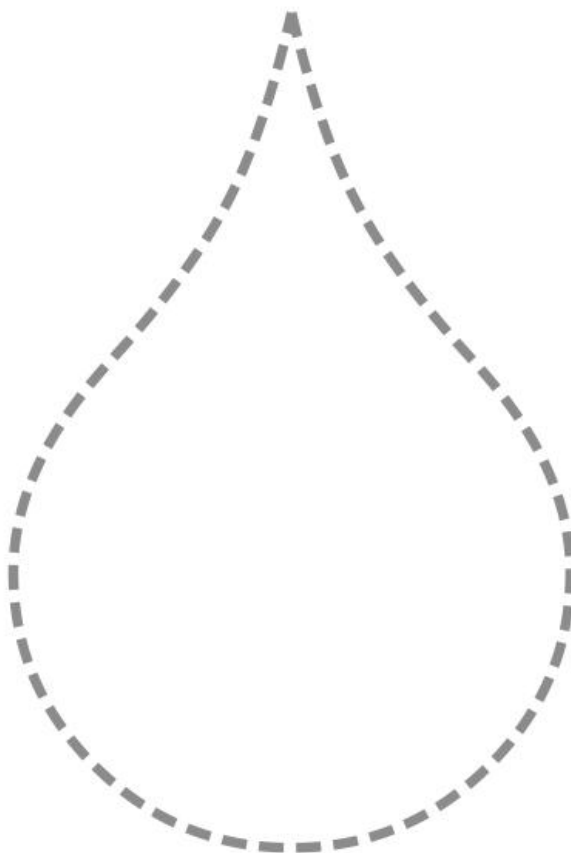

hexágono

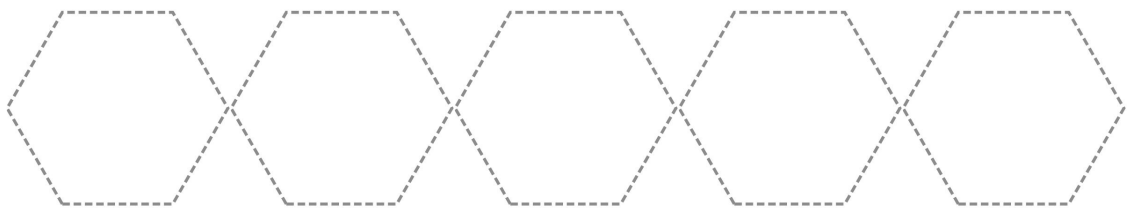
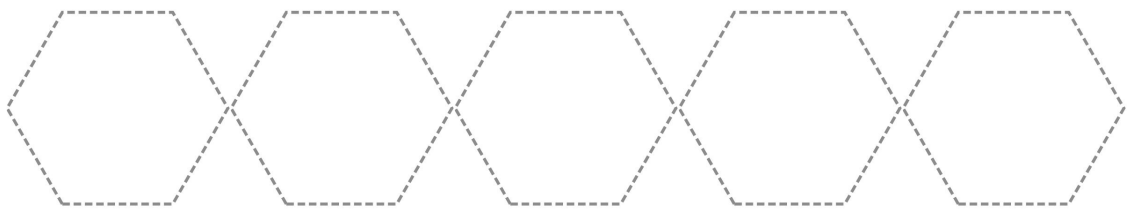
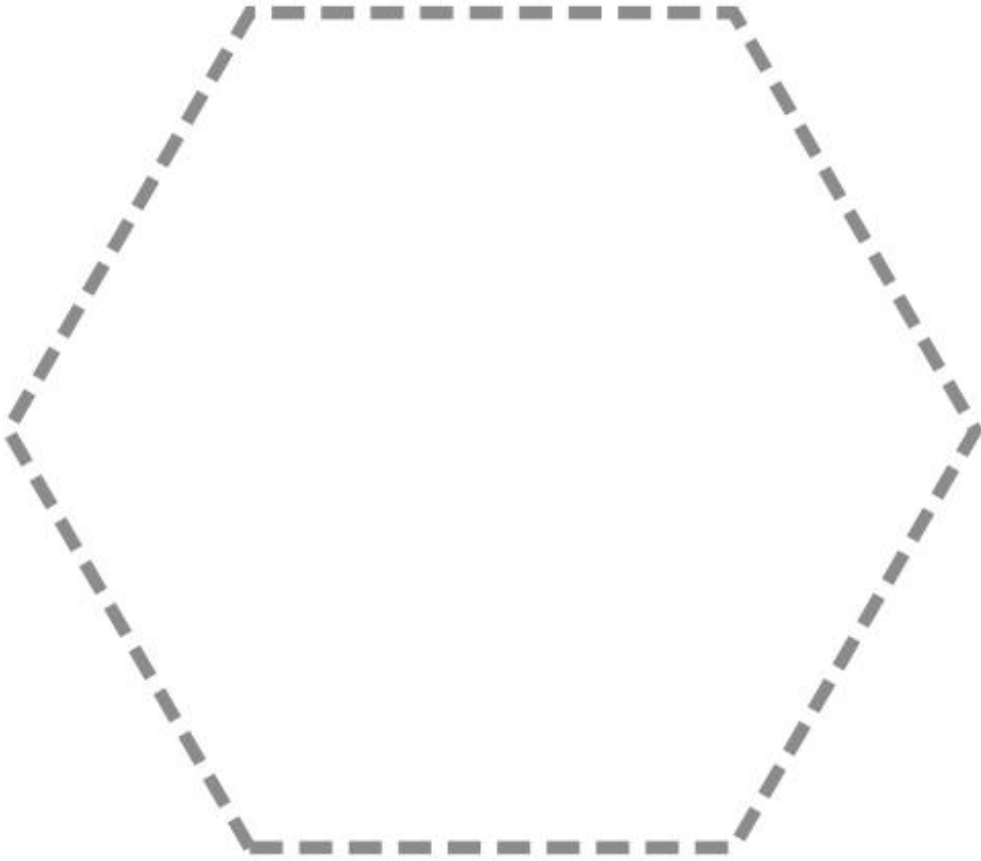

Escudo

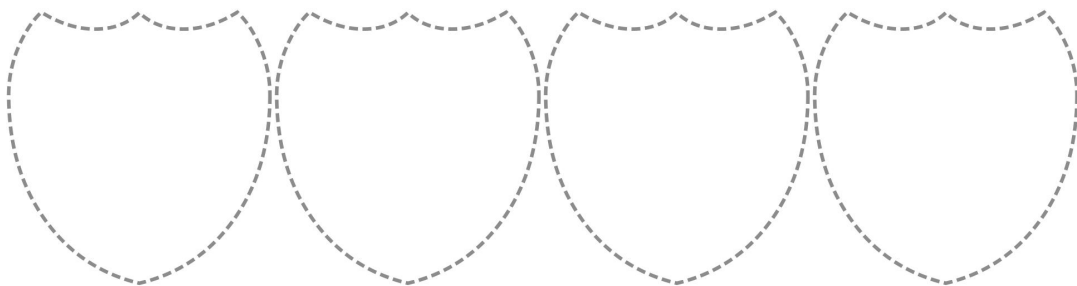
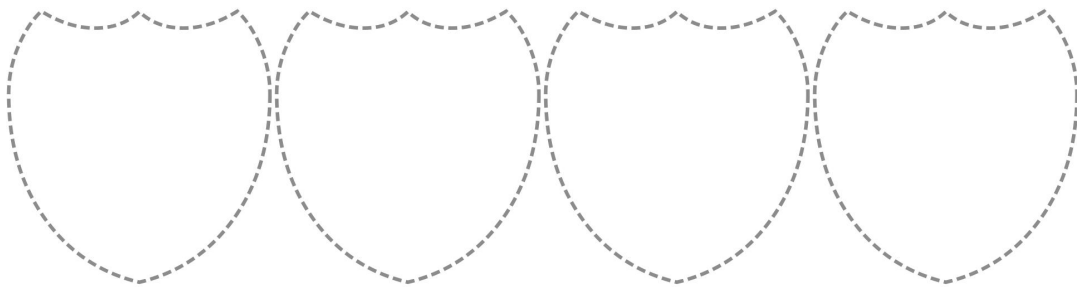
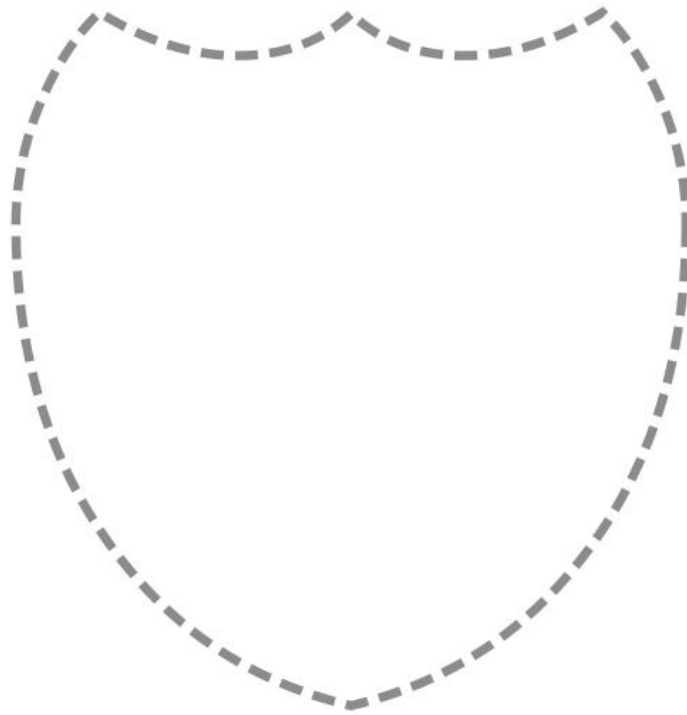

triángulo

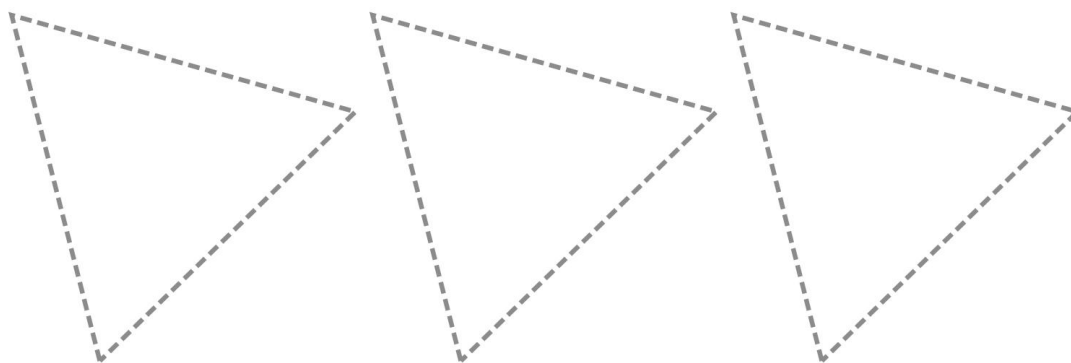
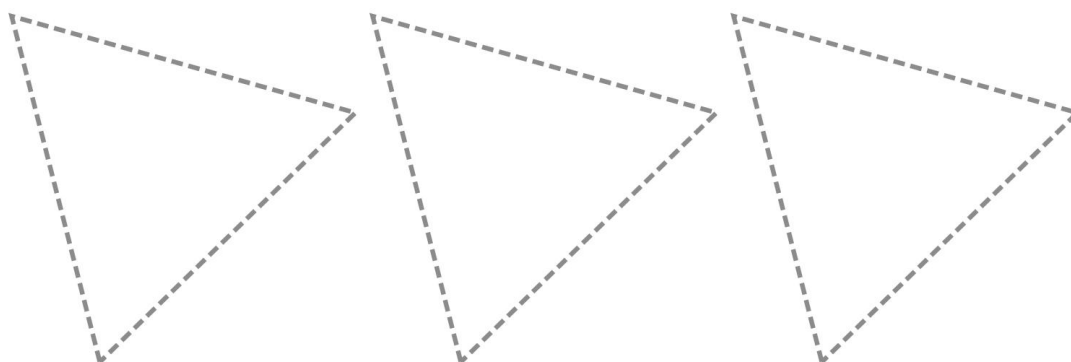
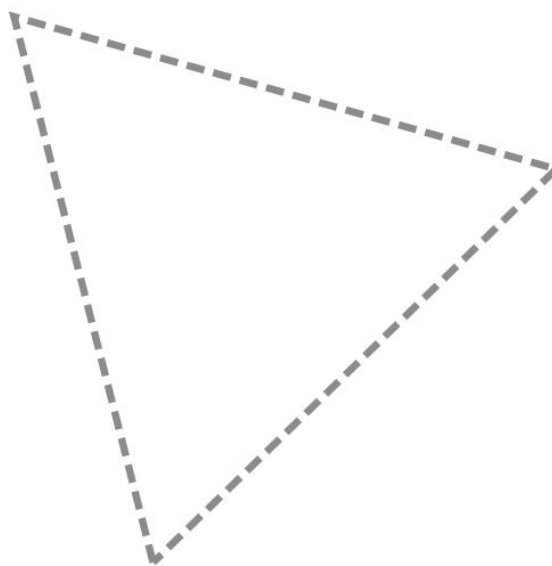

trapezio



triángulo

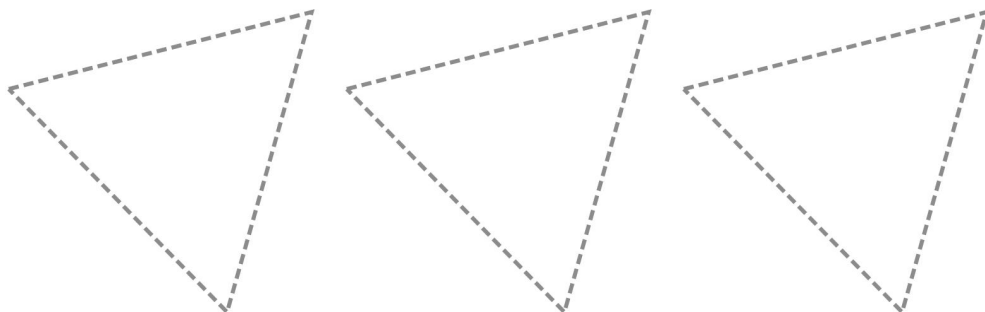
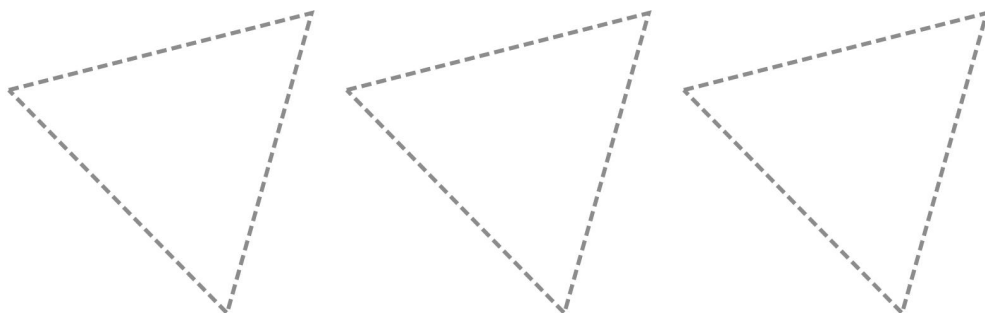
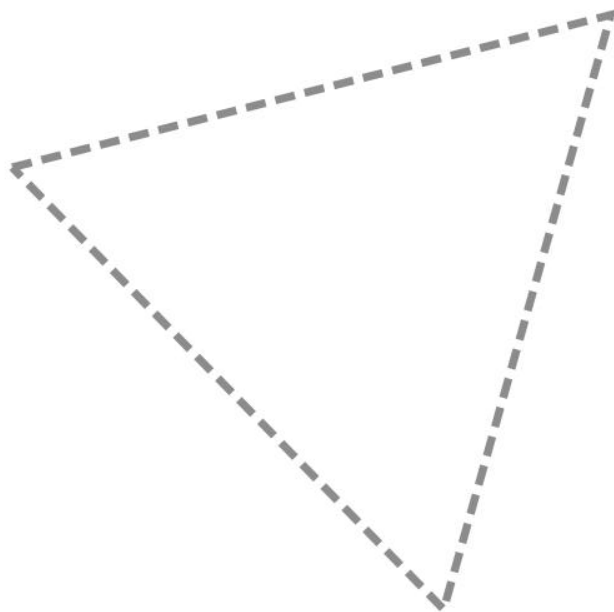

Cuadrado



Rombo

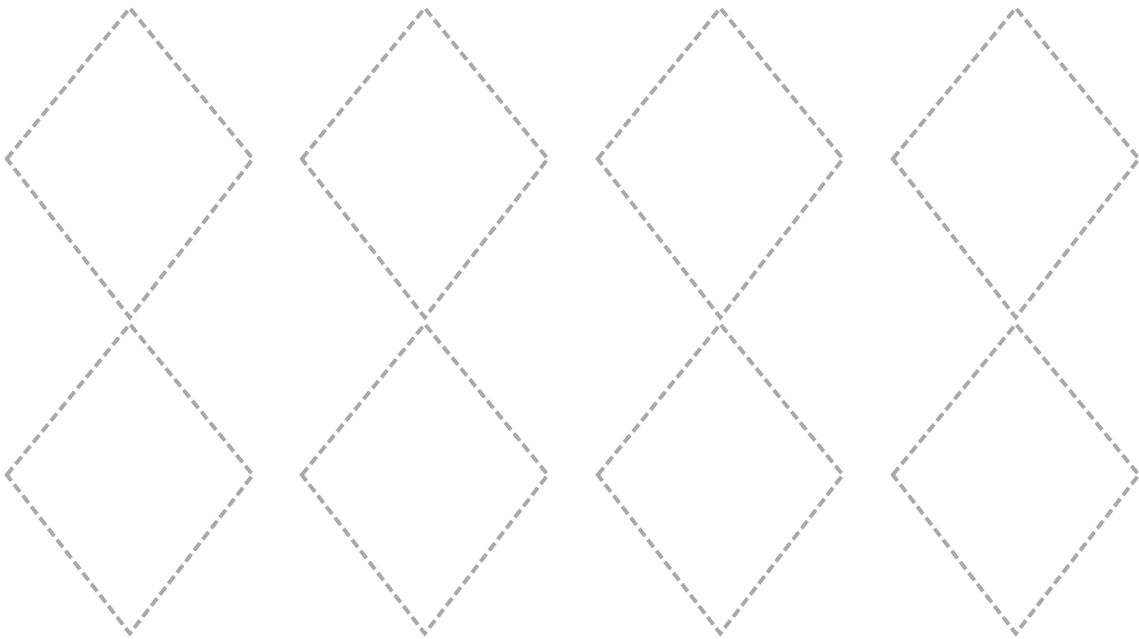
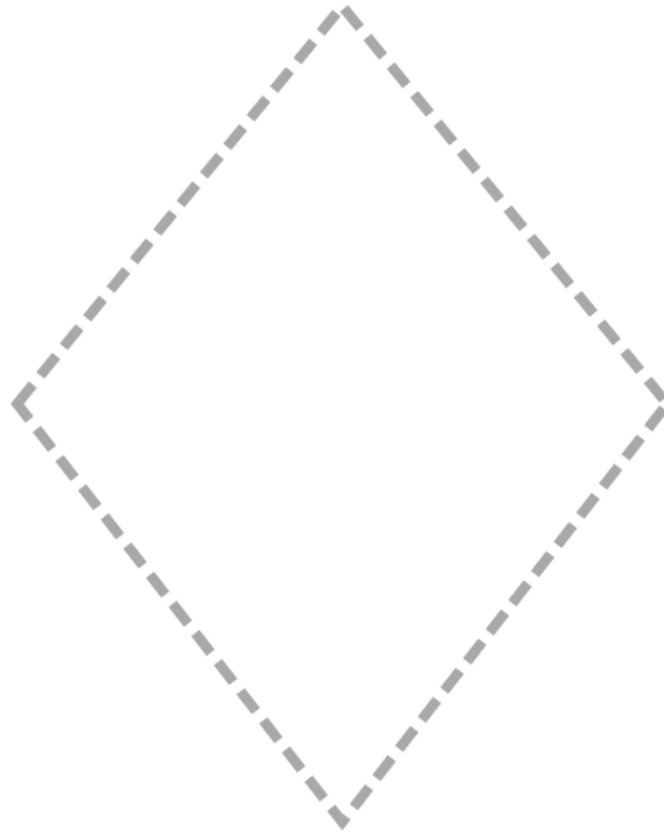

Triángulo

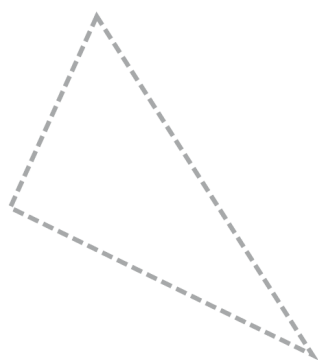
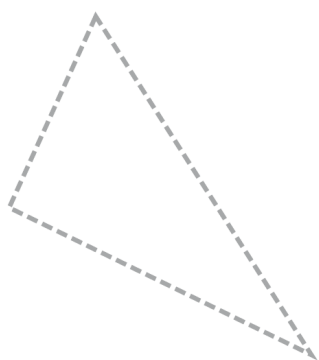
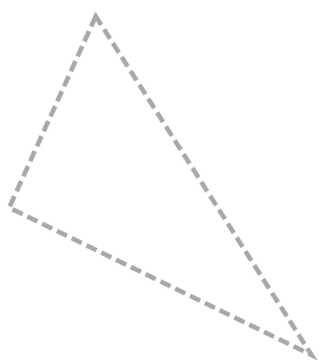
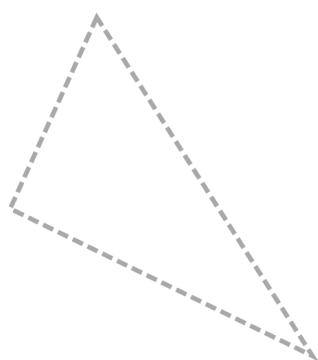
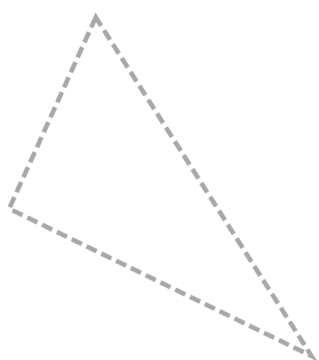
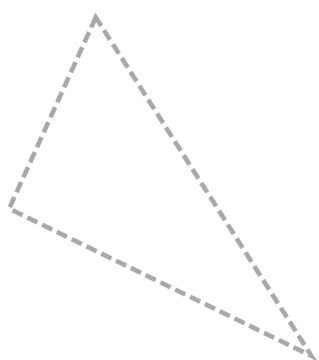
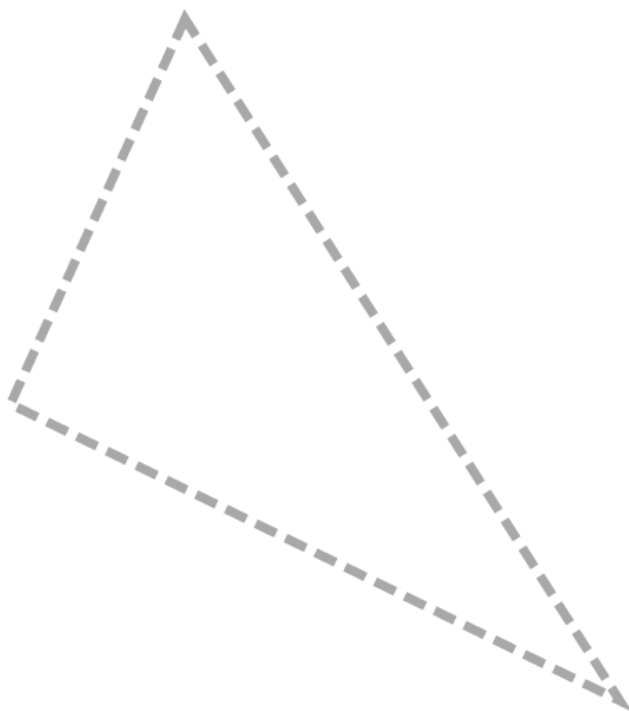

Comecocos

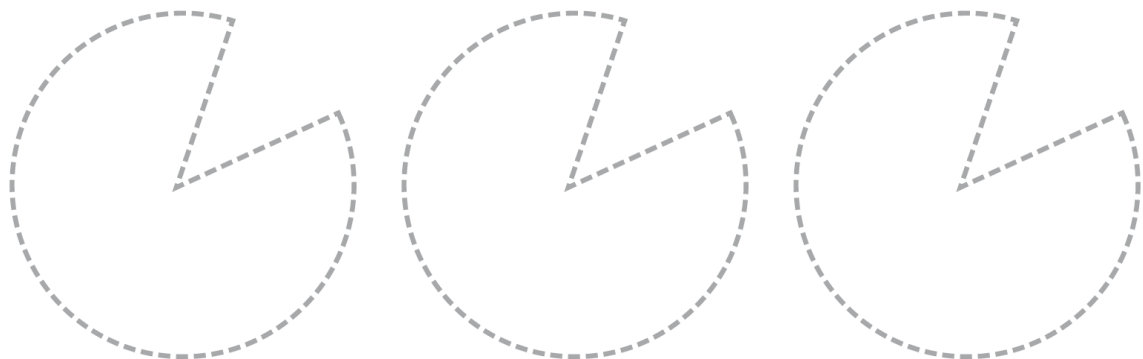
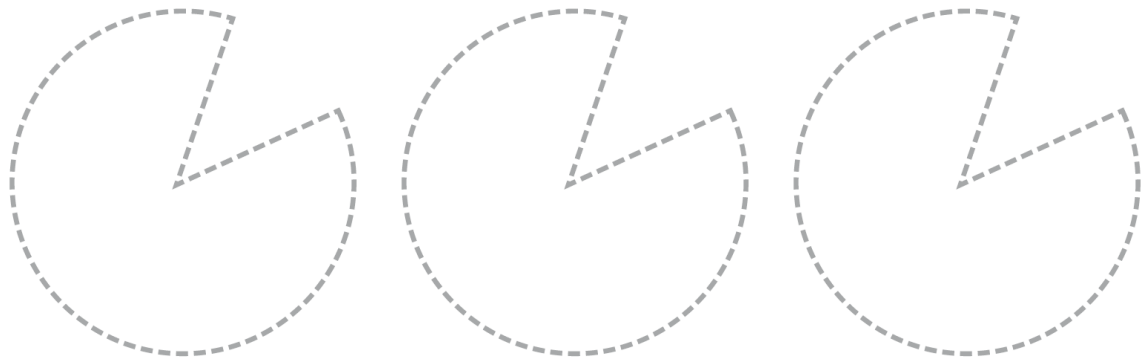
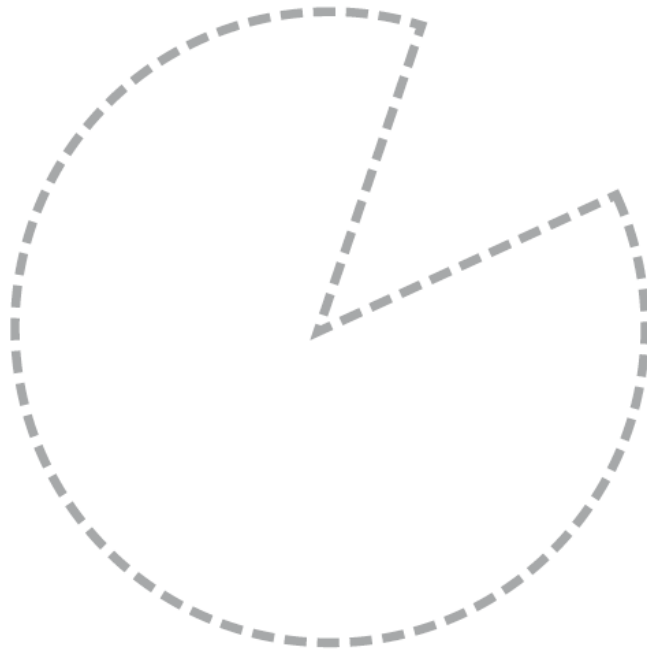

Avión



Estrella

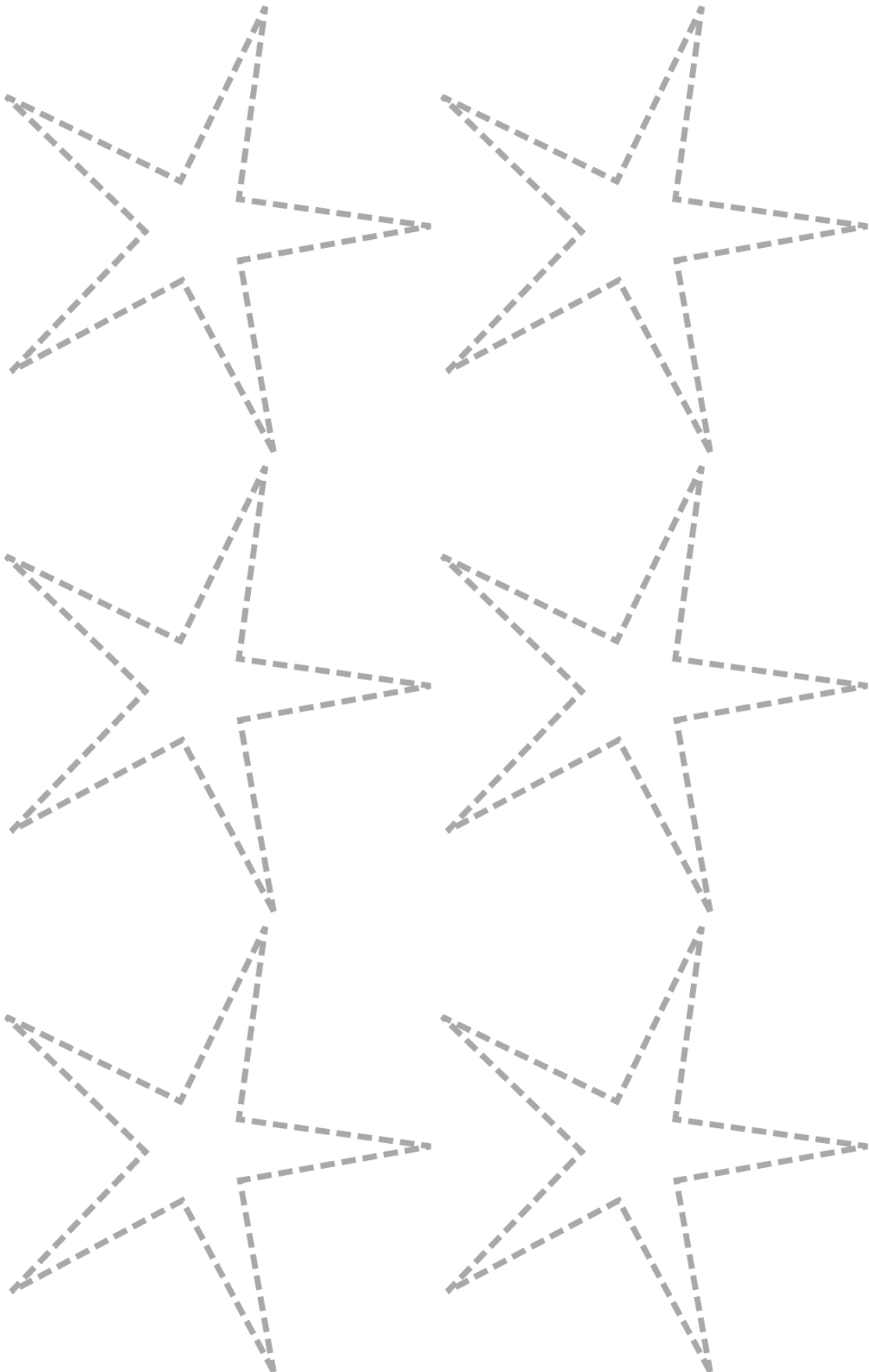

Octógono

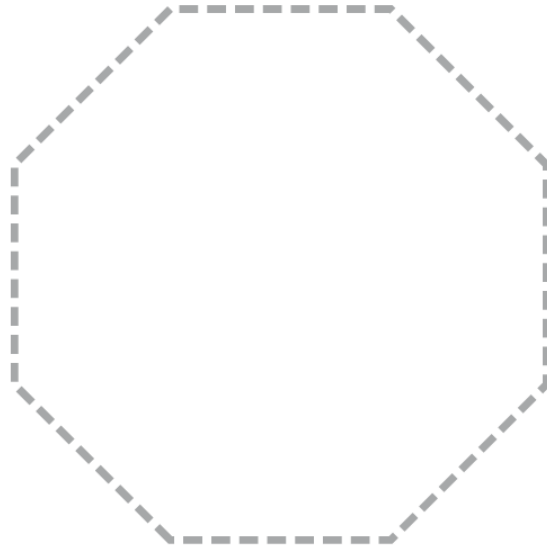

Martillo

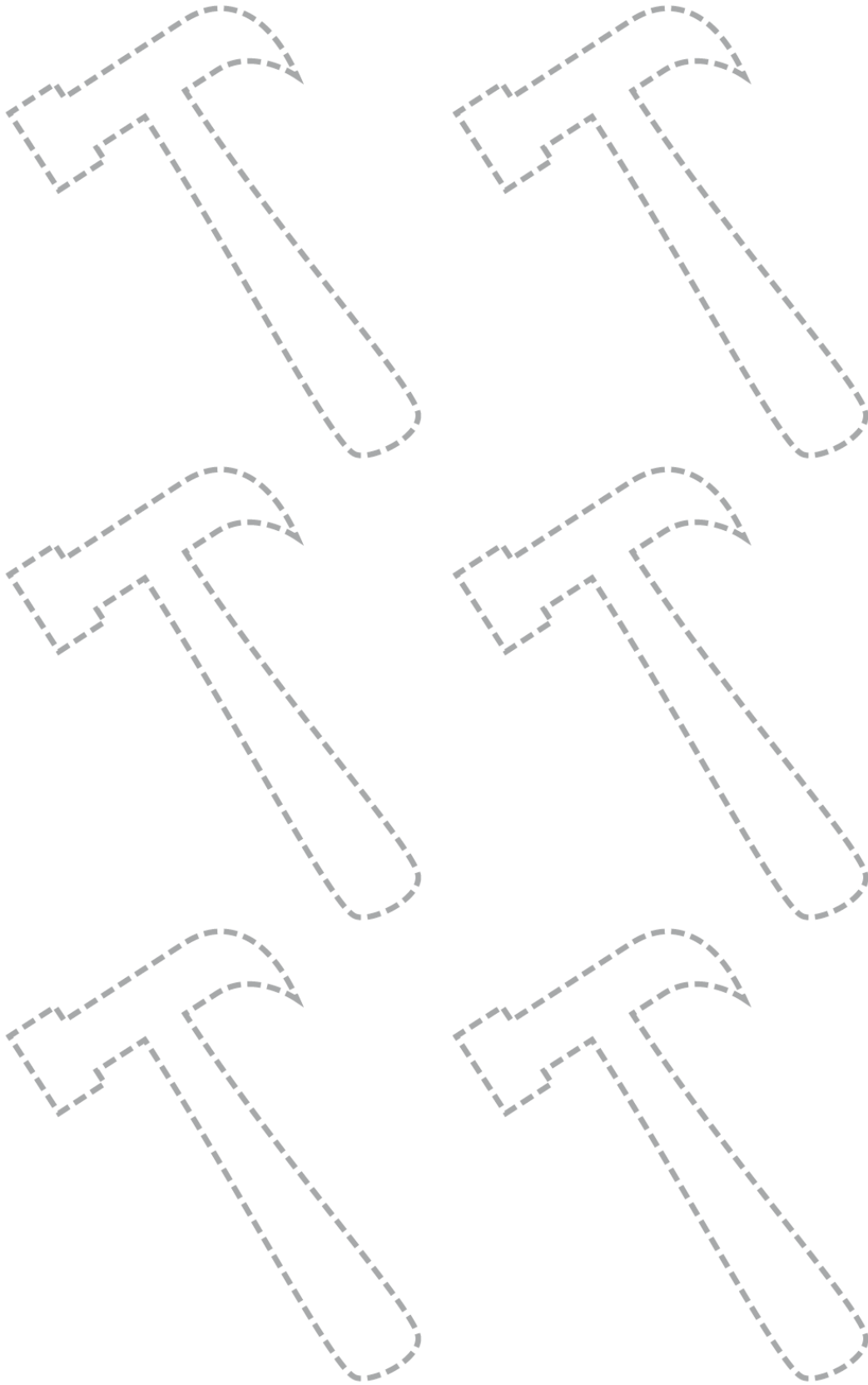

Pentágono

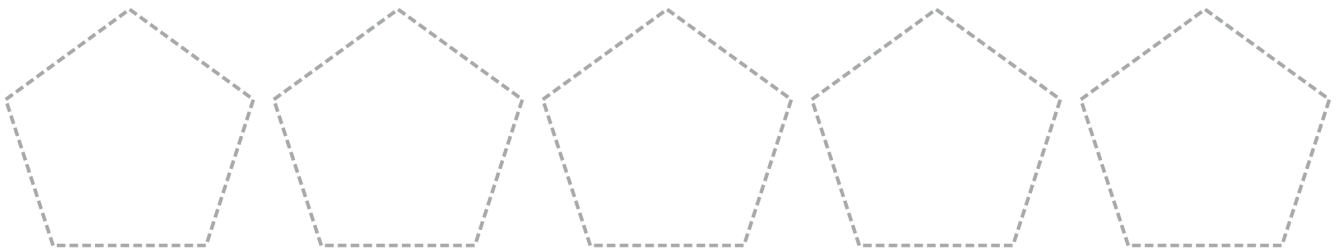
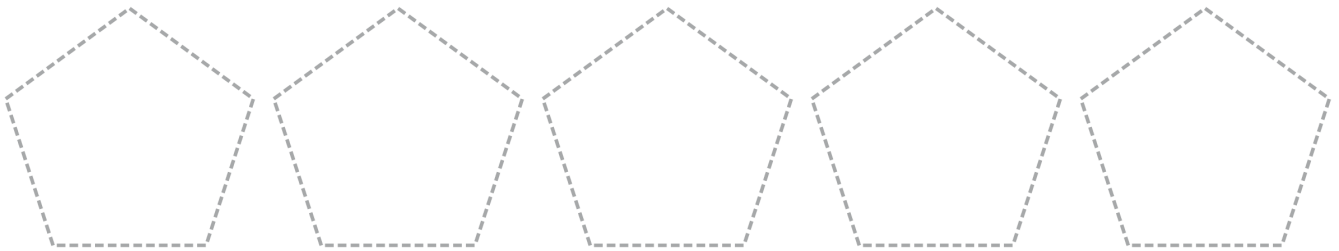
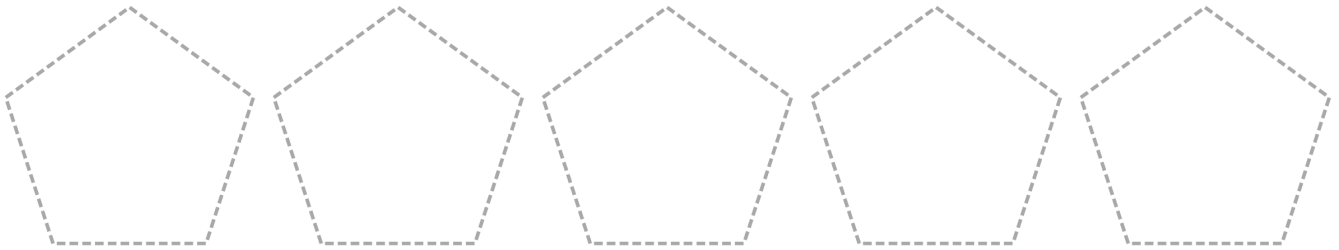
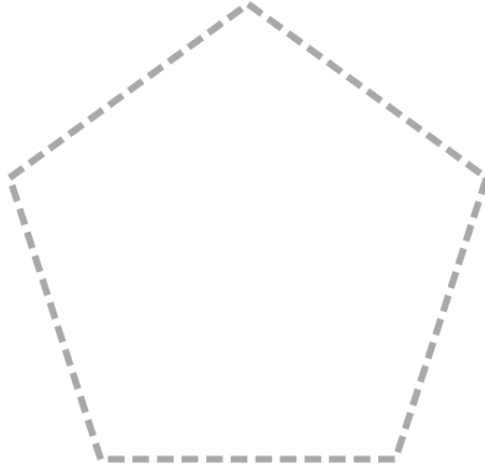

Corazón



Rayo

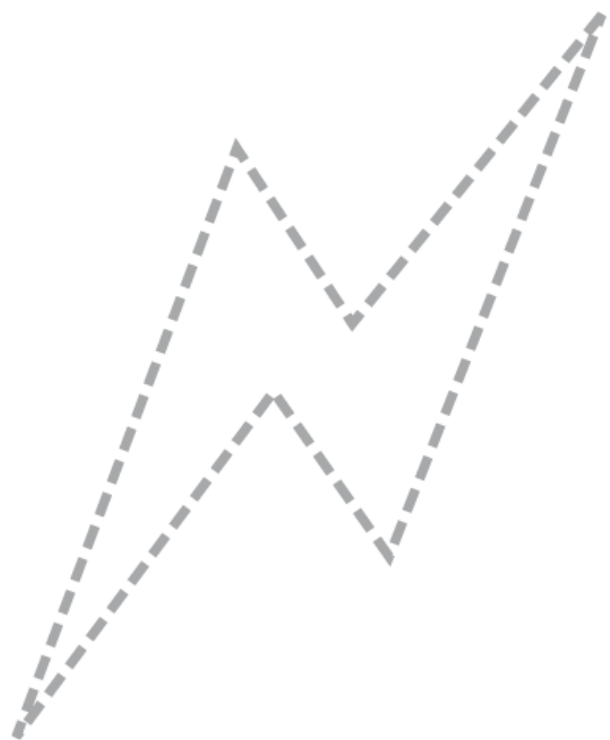
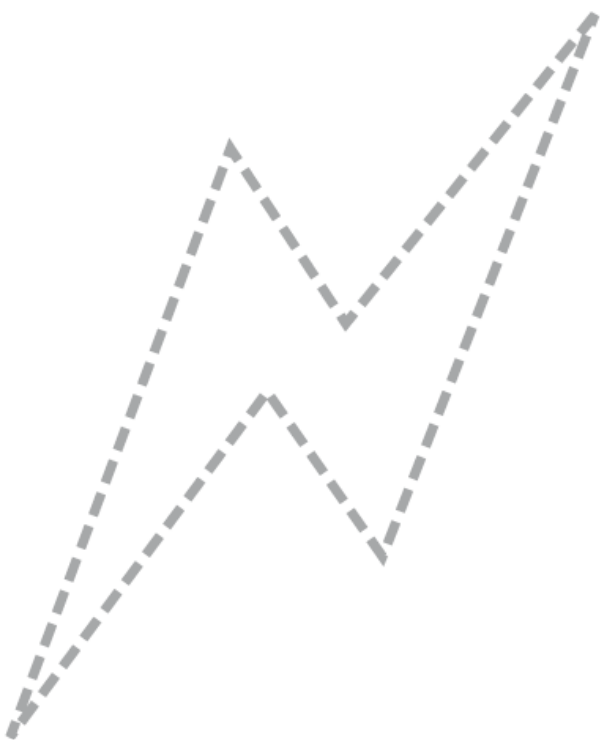
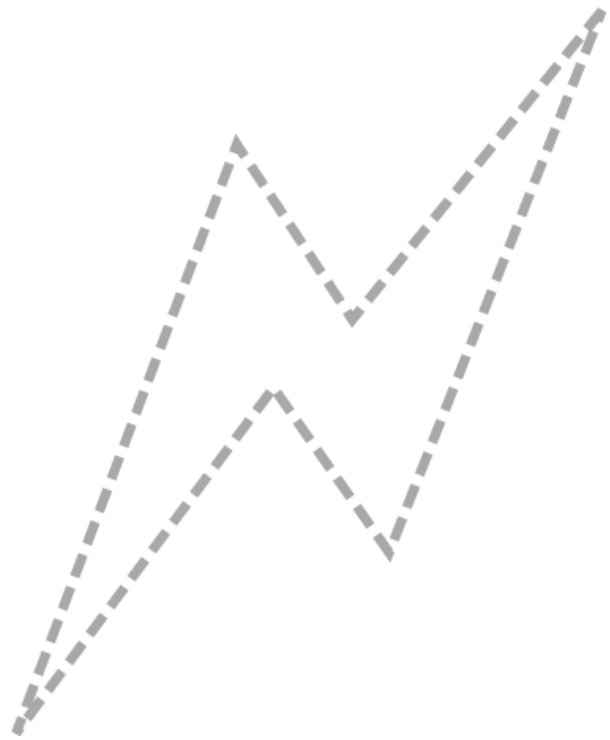
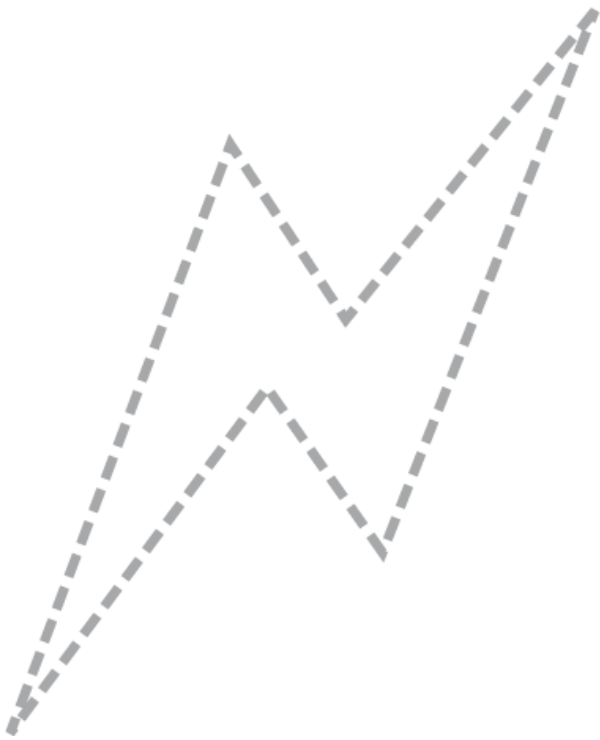

Espiral

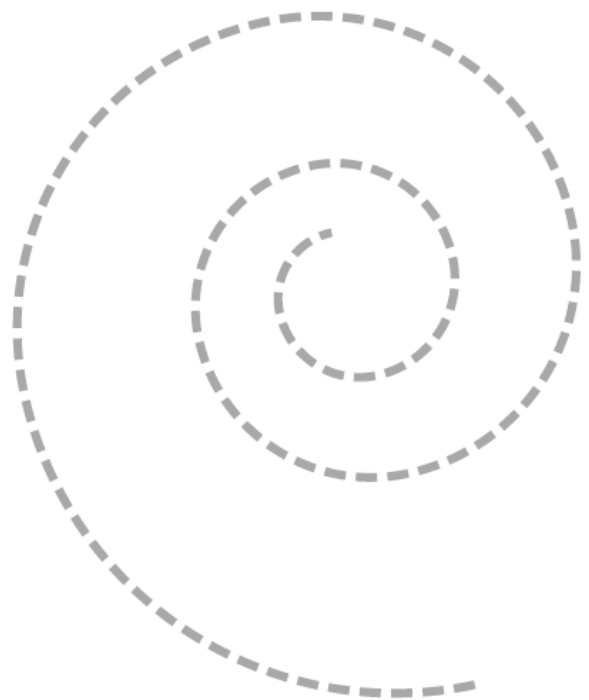
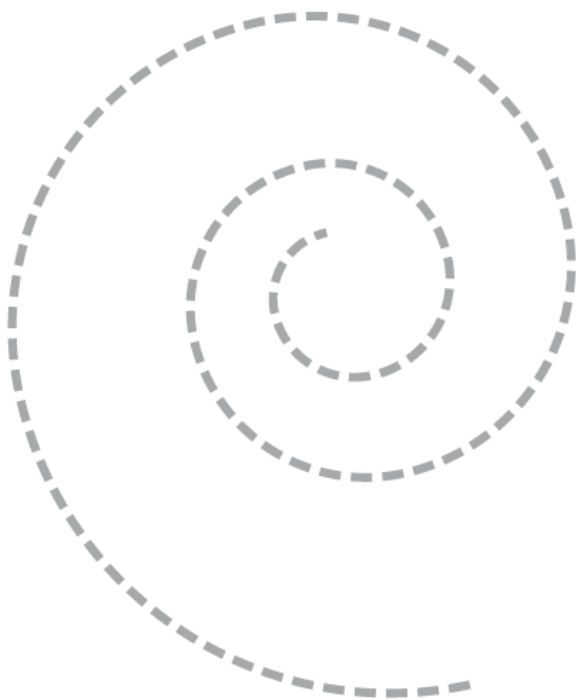
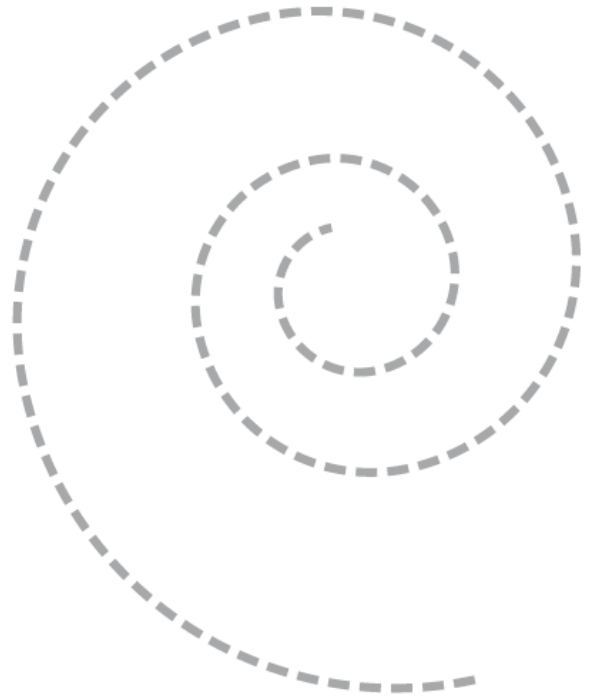
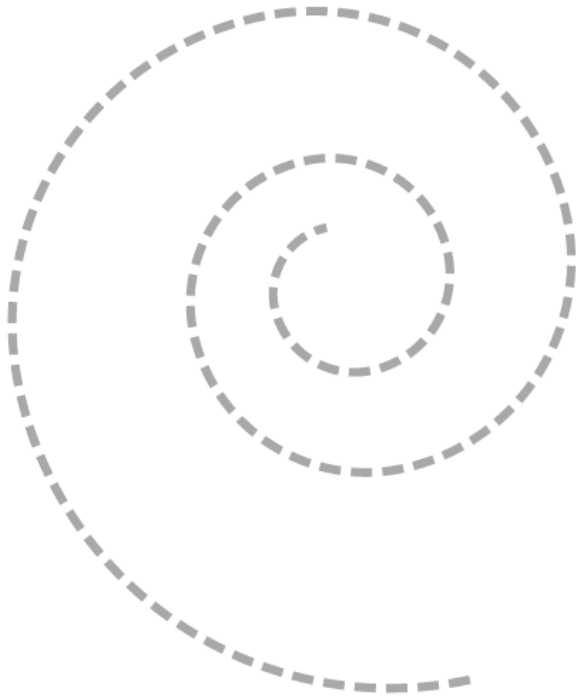

Flor

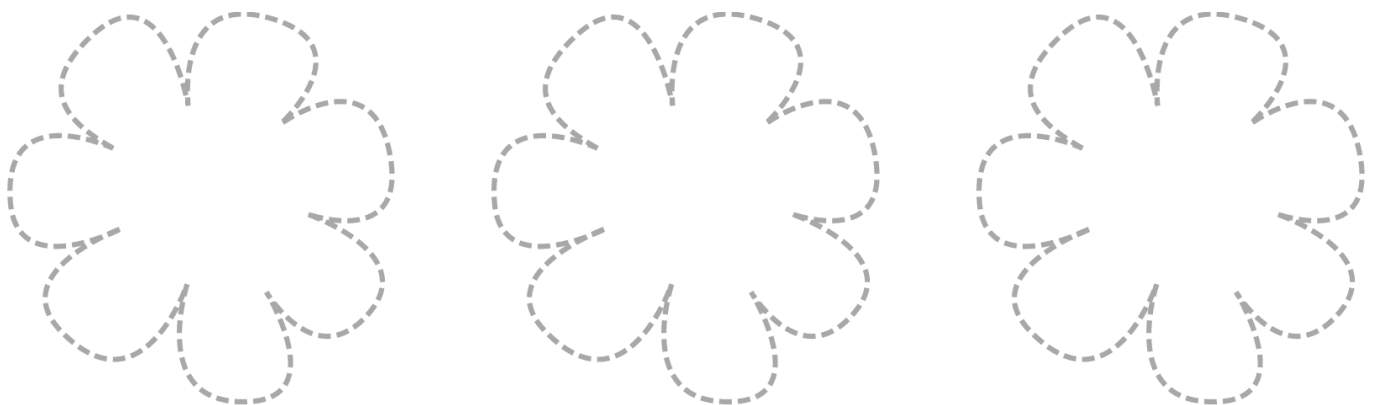
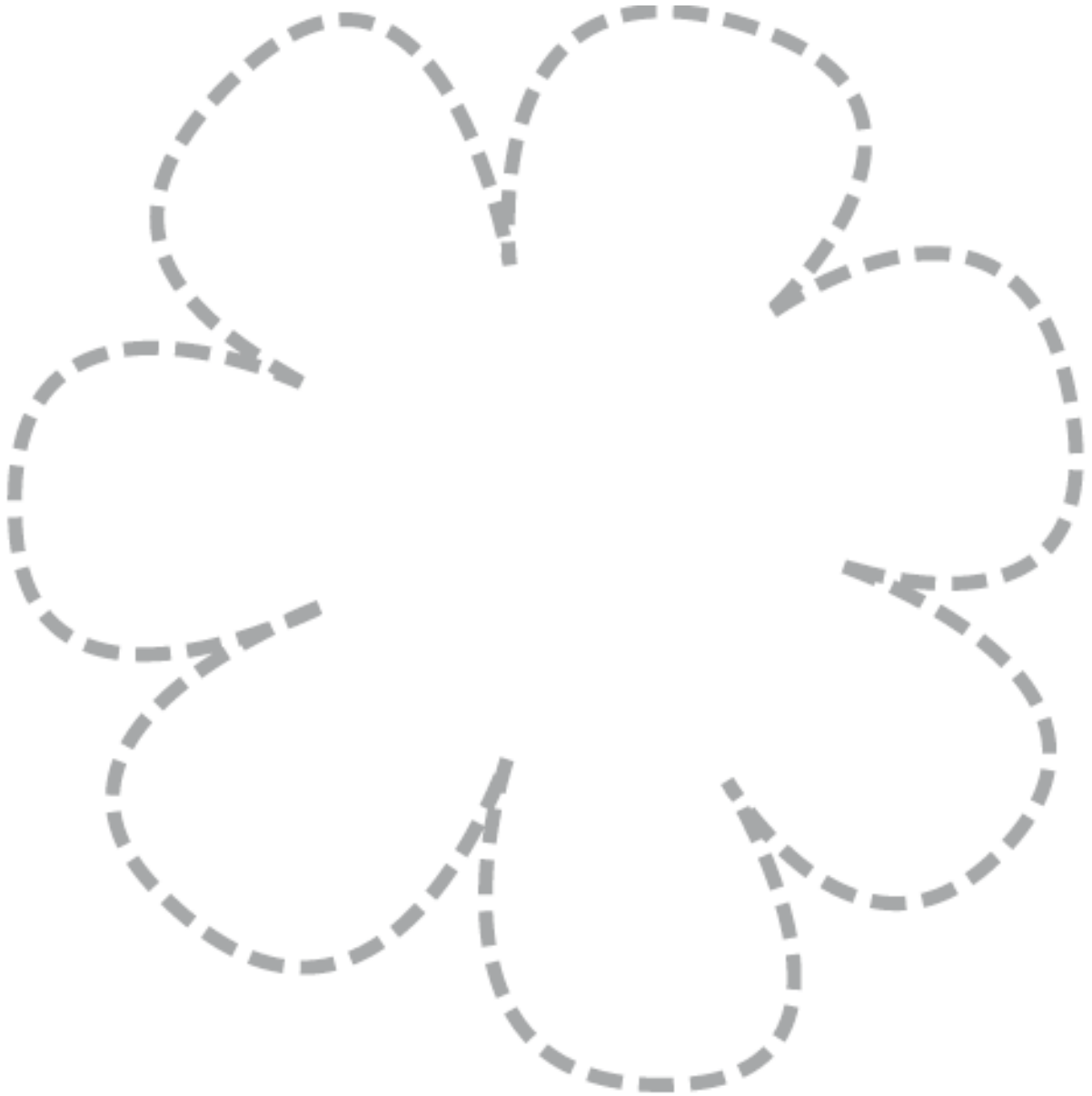

Flor

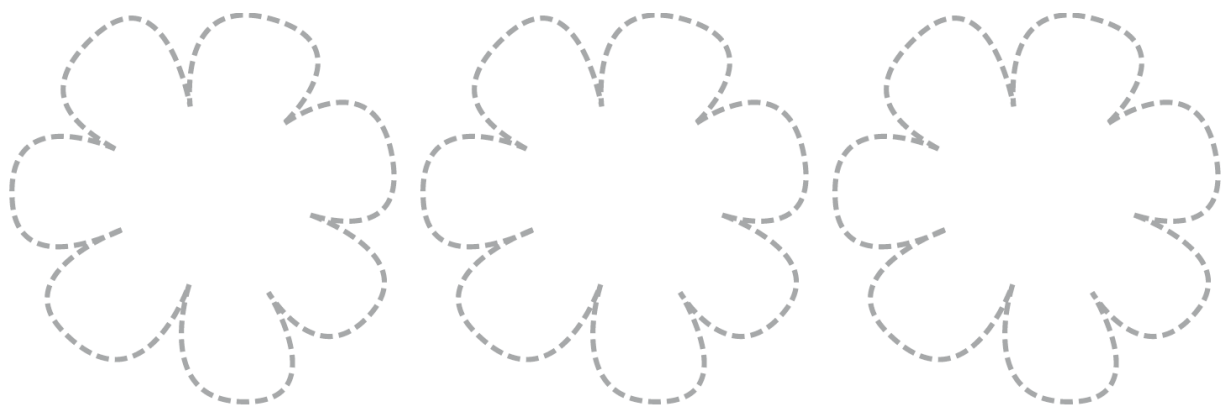
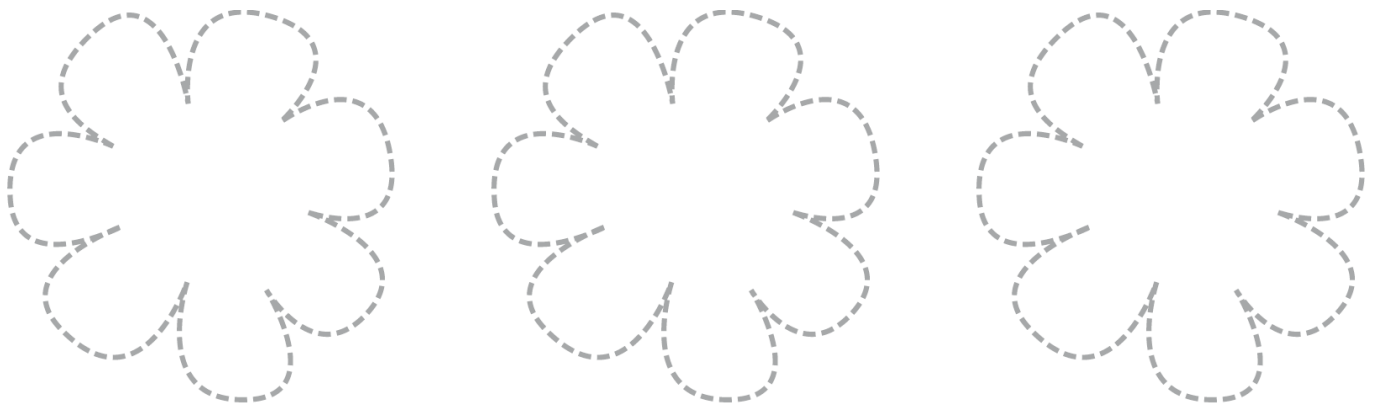
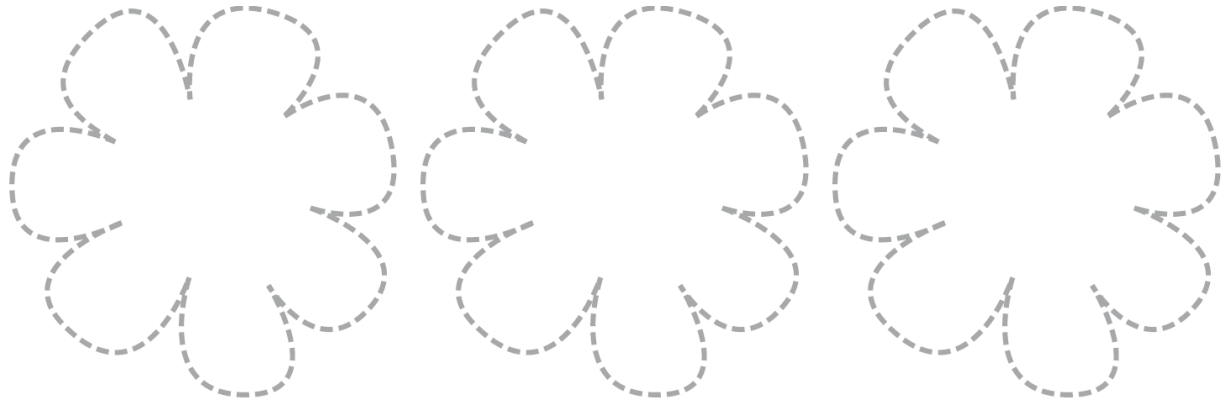

Flecha

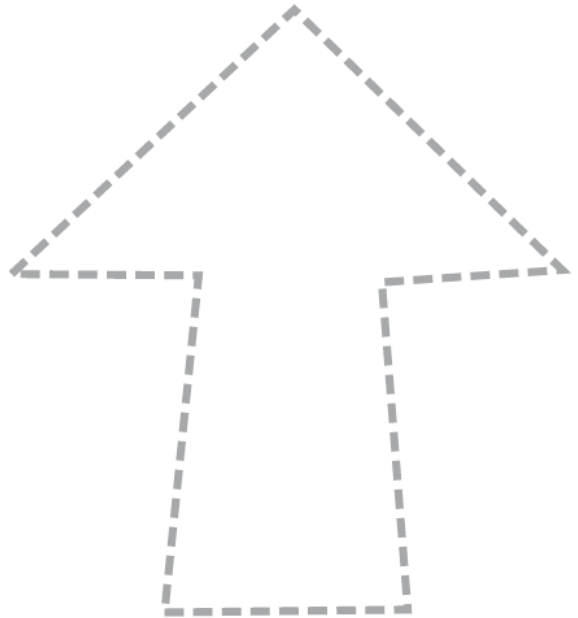
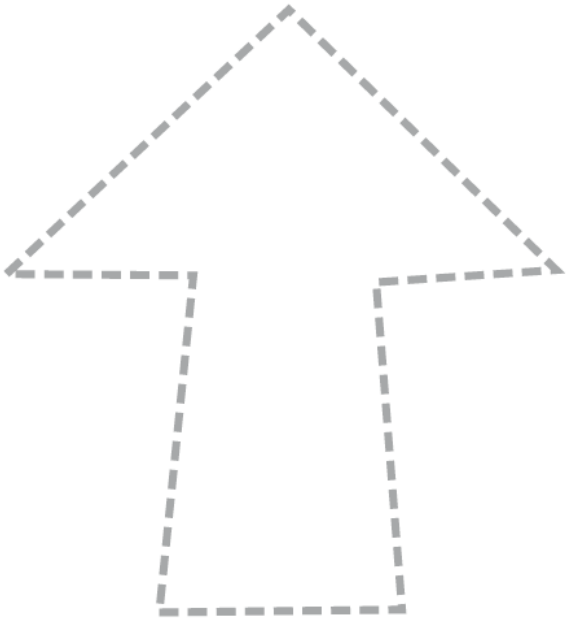
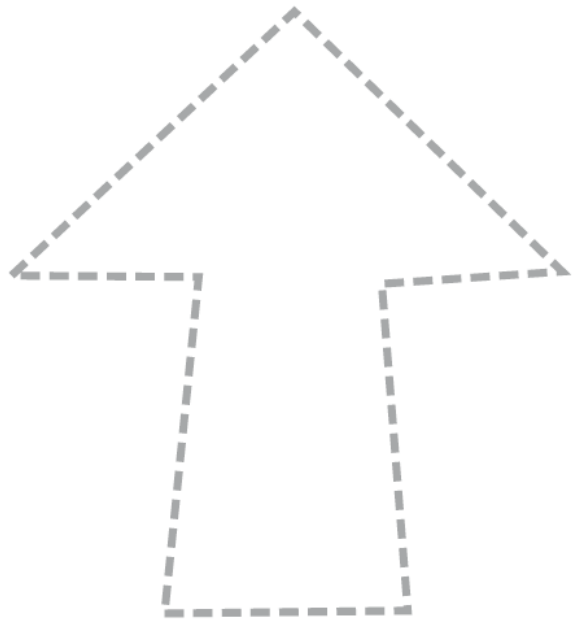
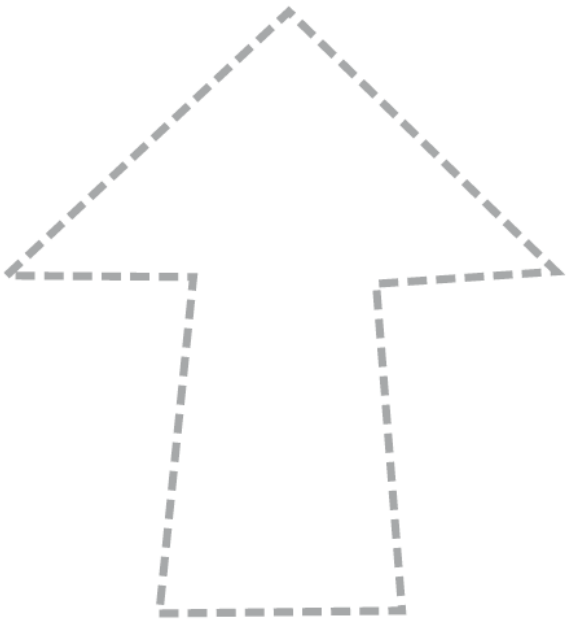

Flecha

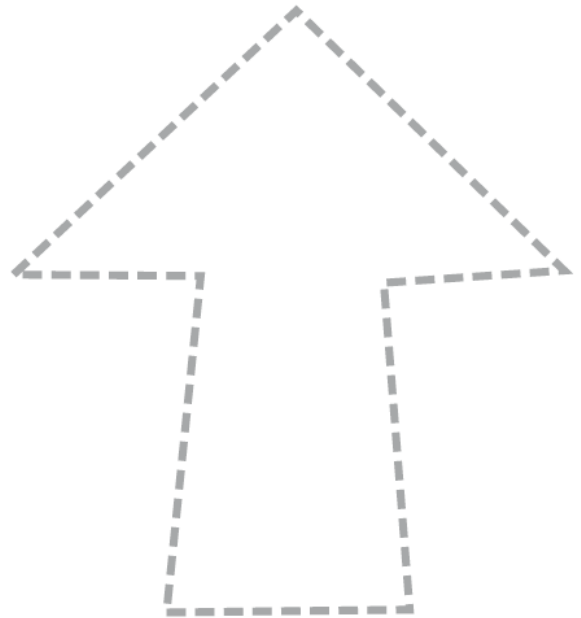
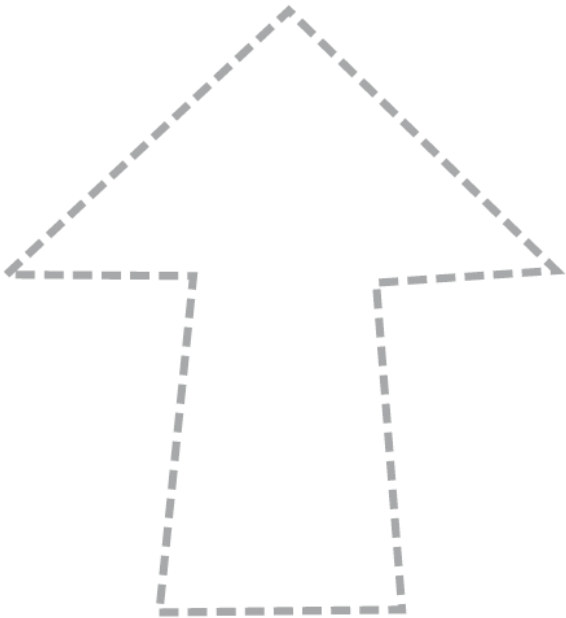
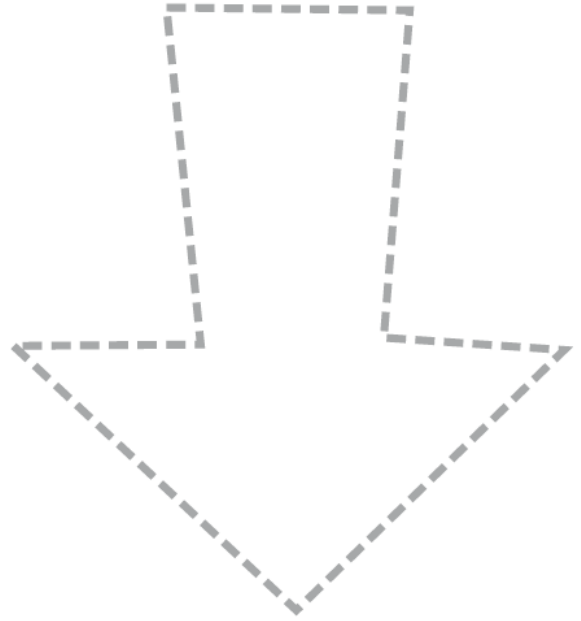
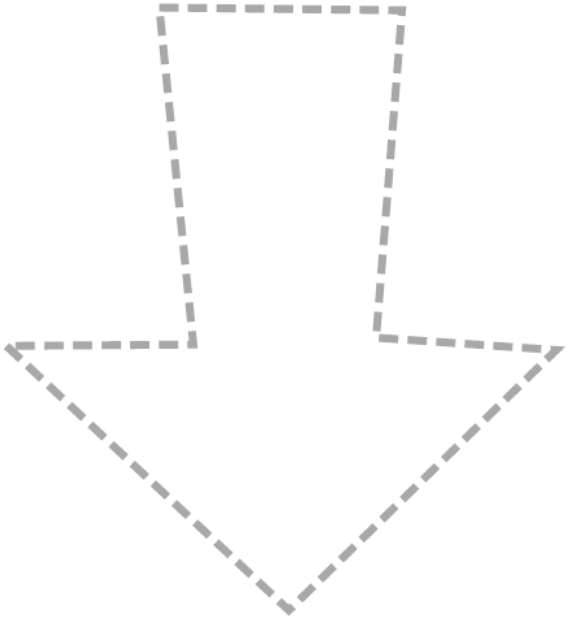

Flecha

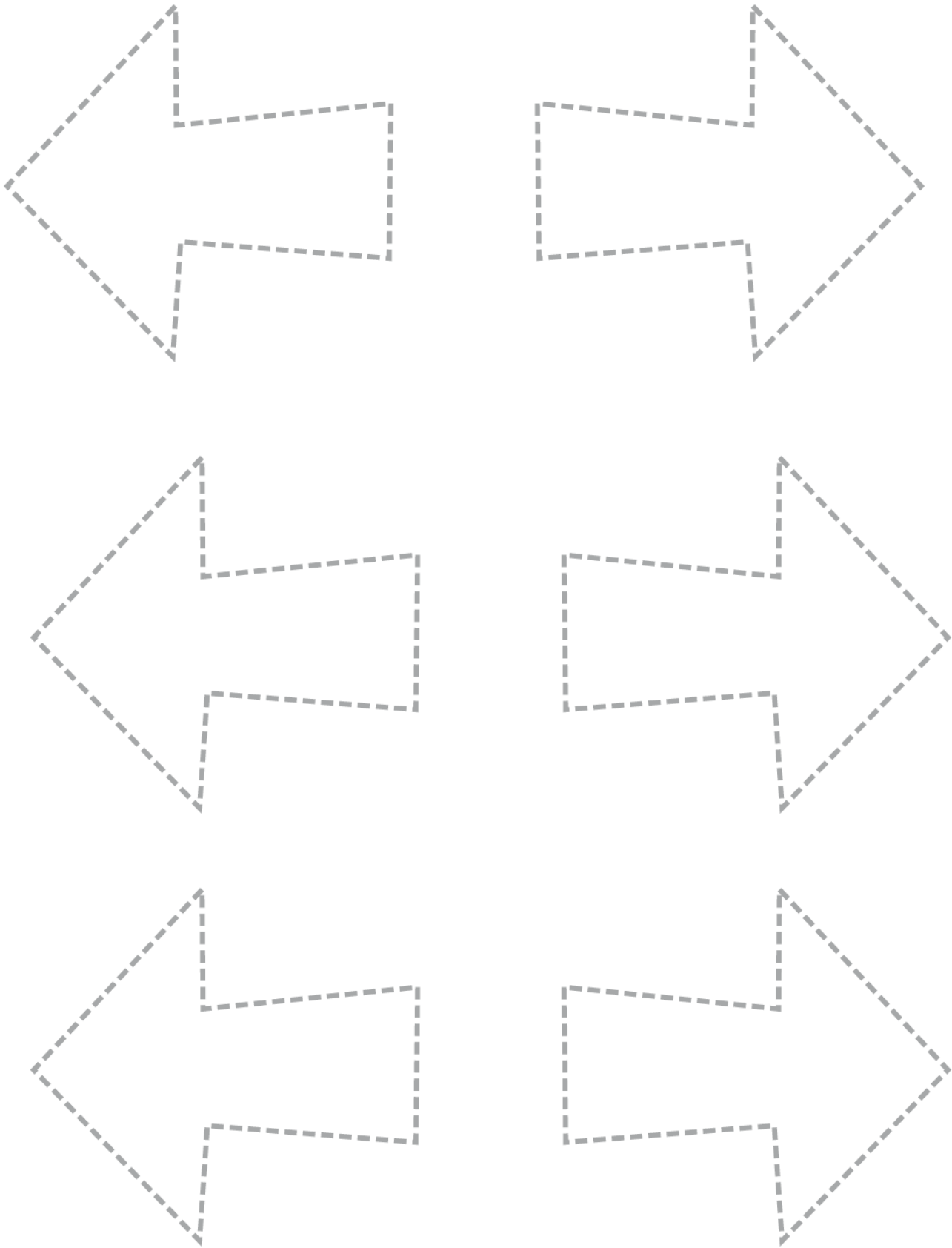

Palmera



Palmera

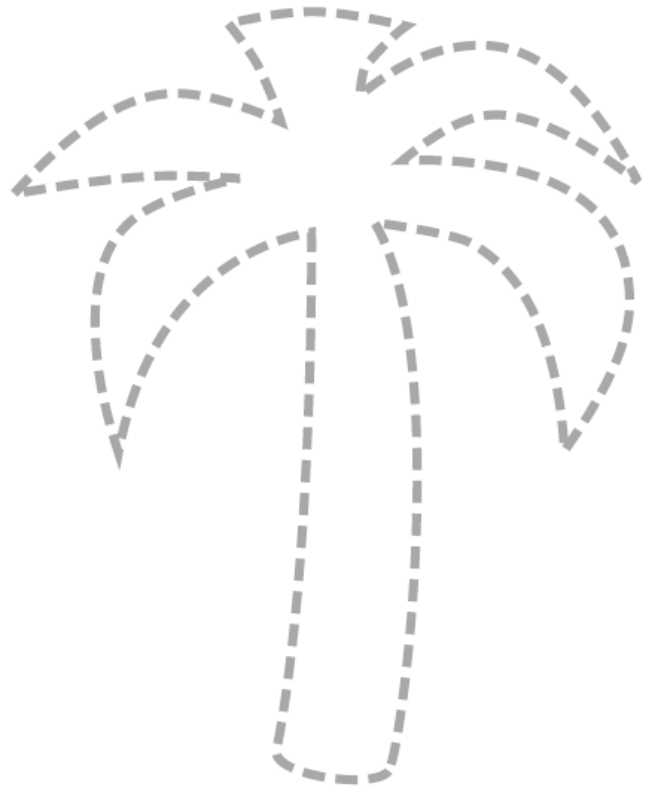

Lazo

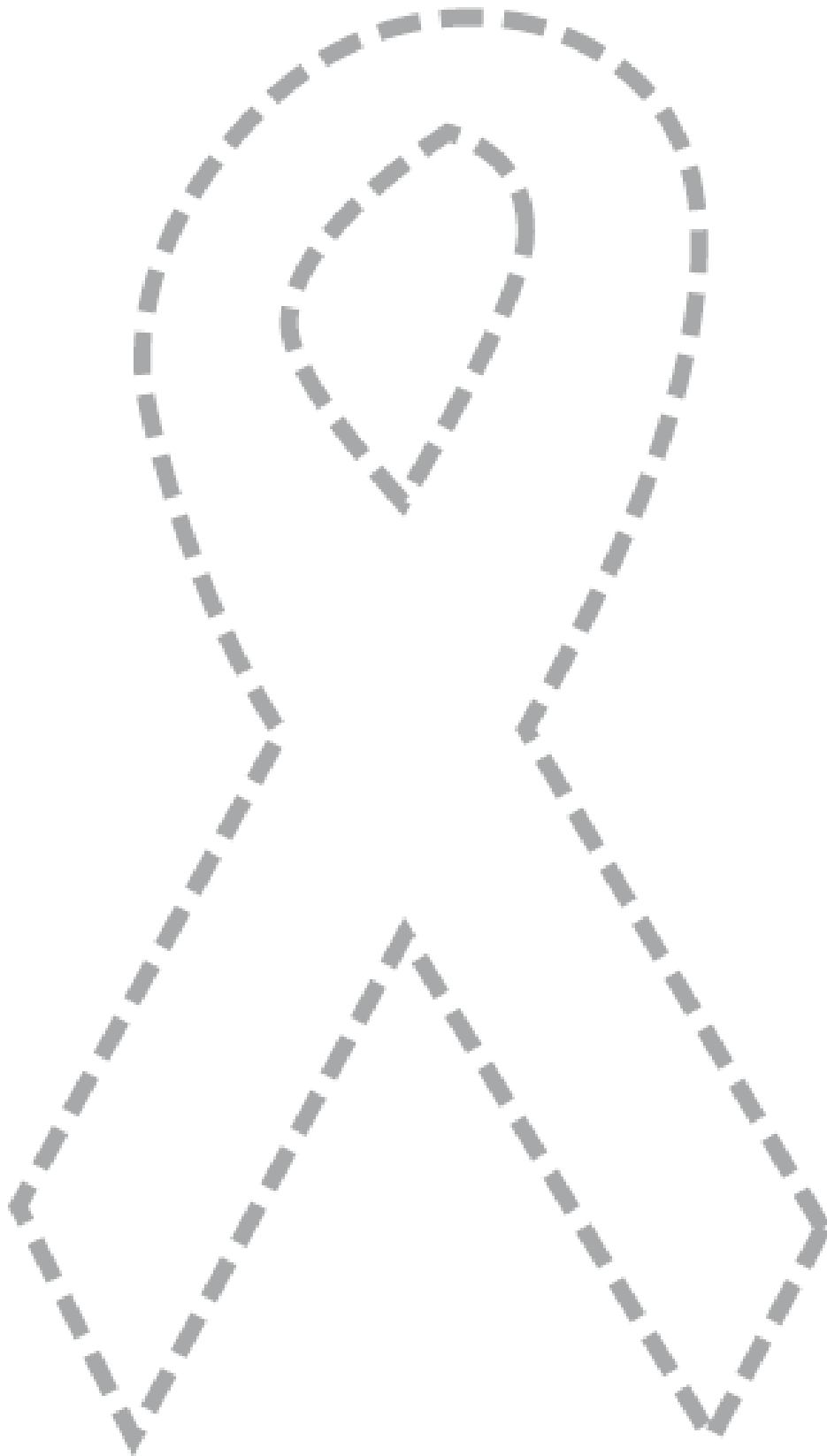

Lazo

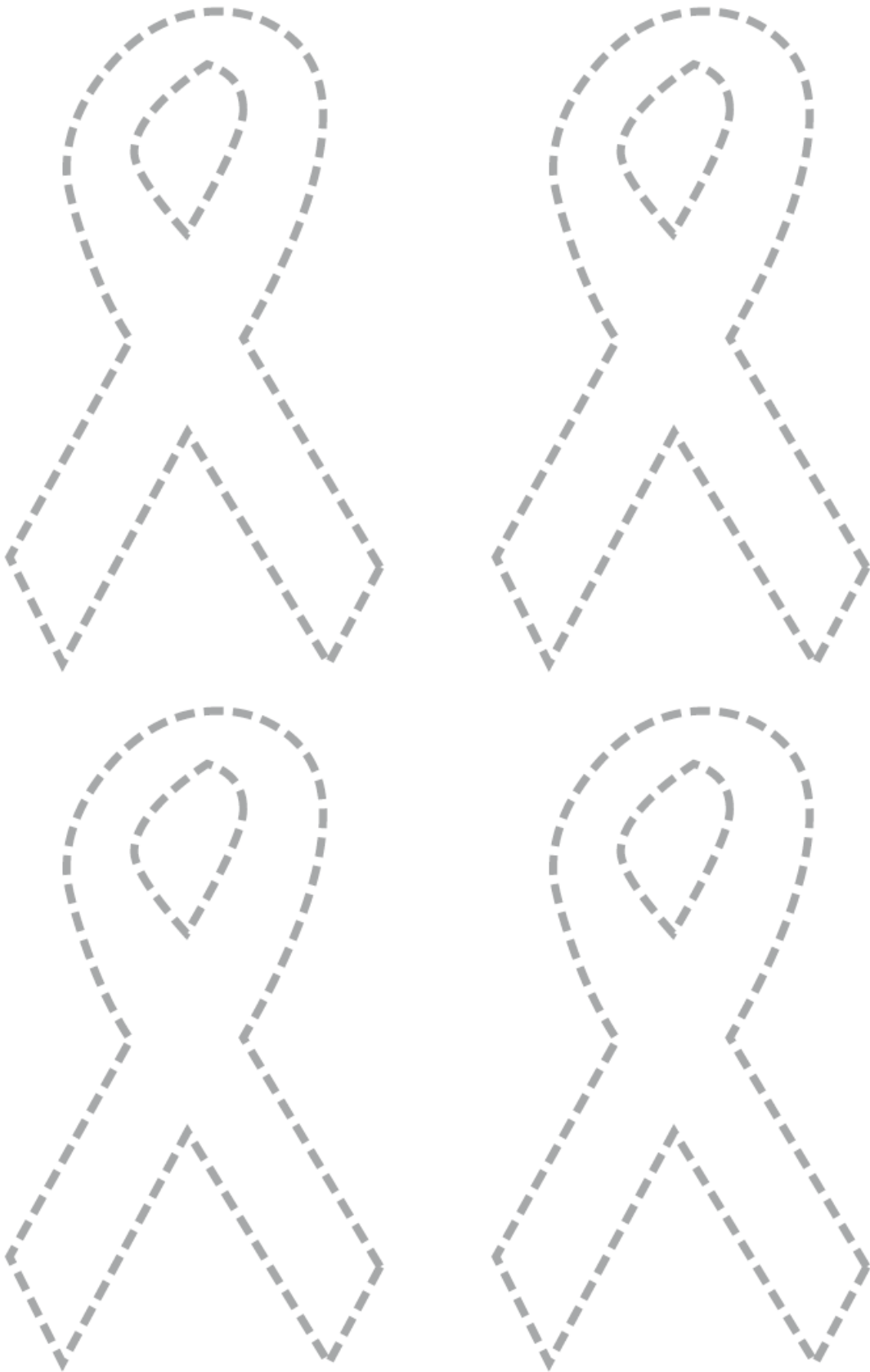

Flechas



Flechas

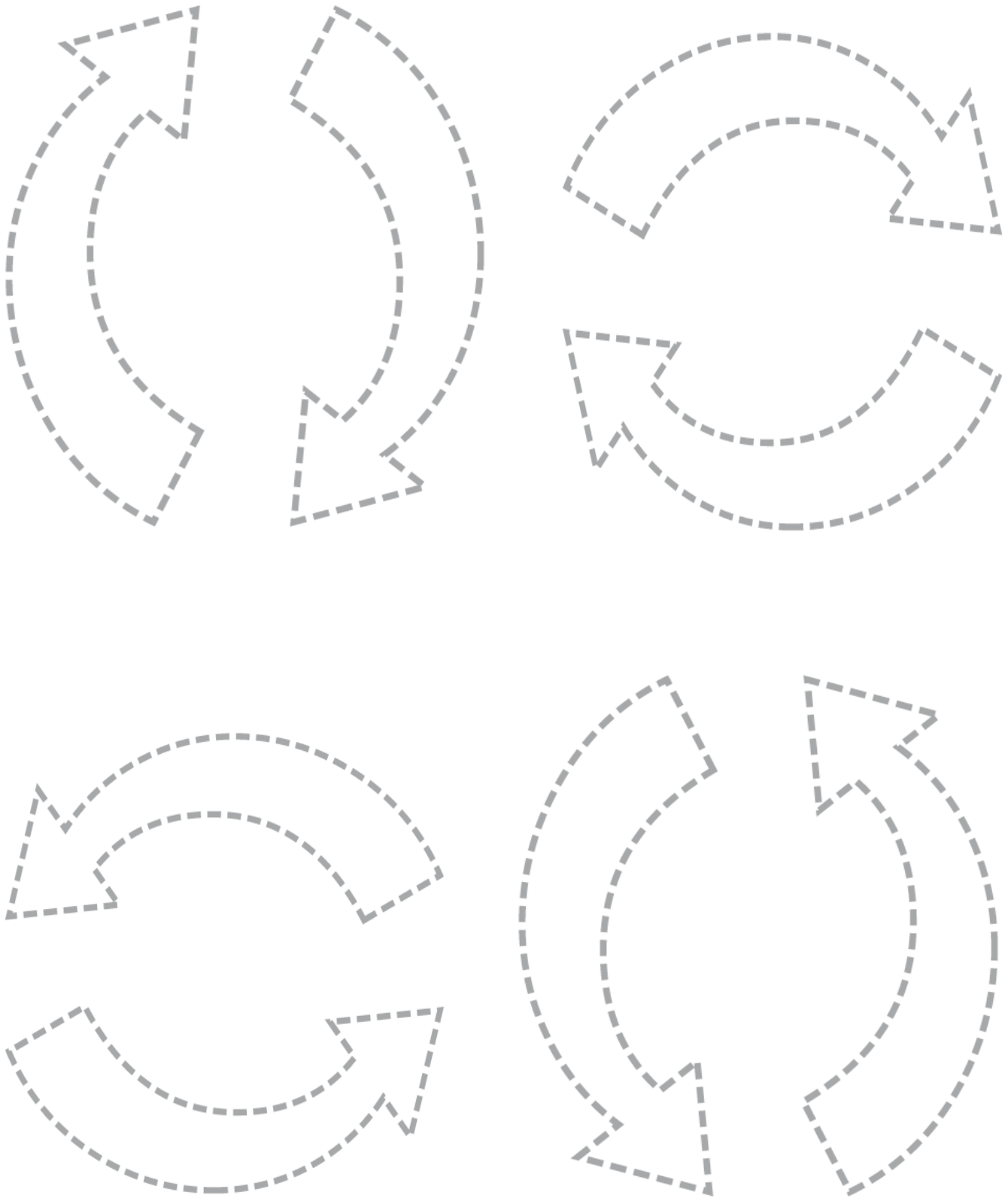

Llave inglesa

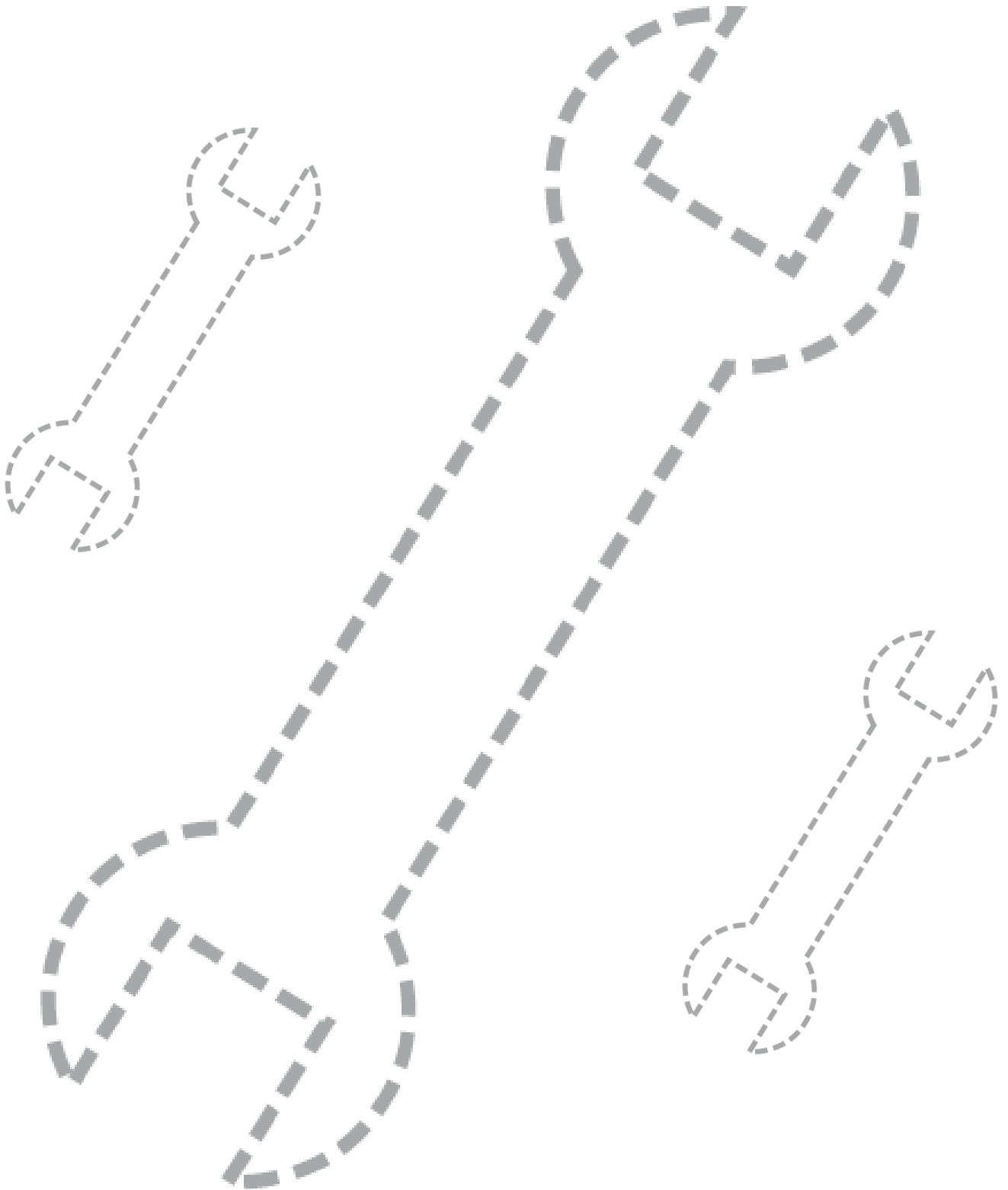

Llave inglesa

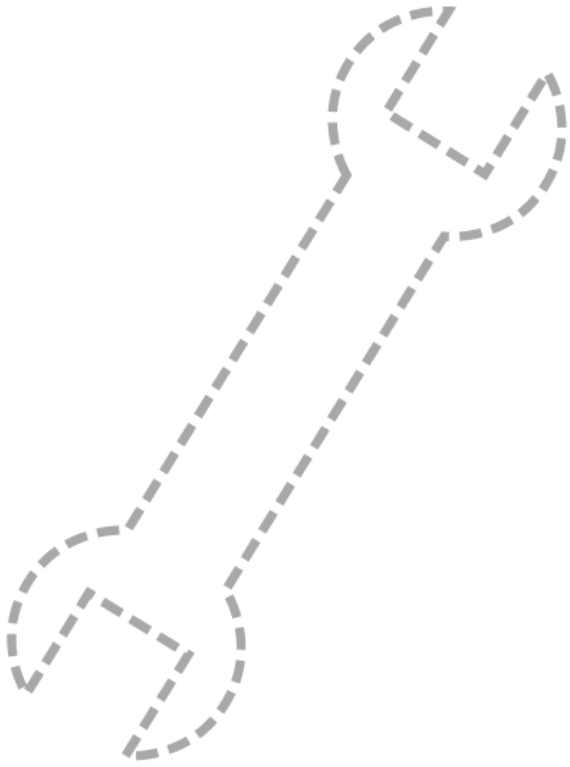

Bomba

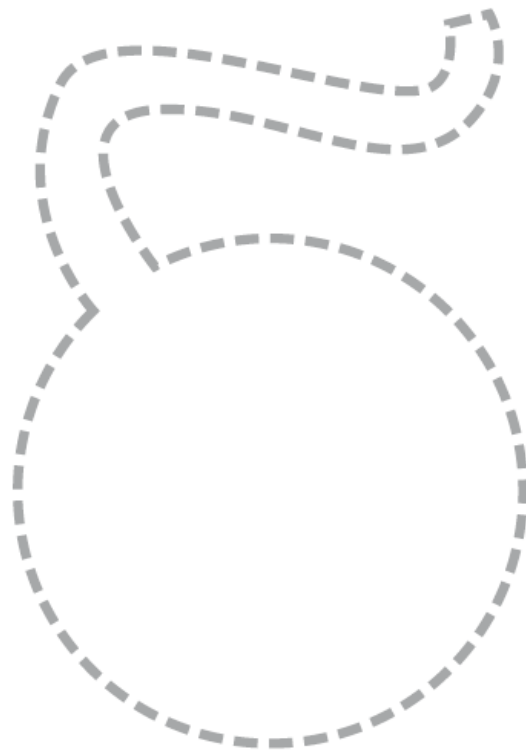
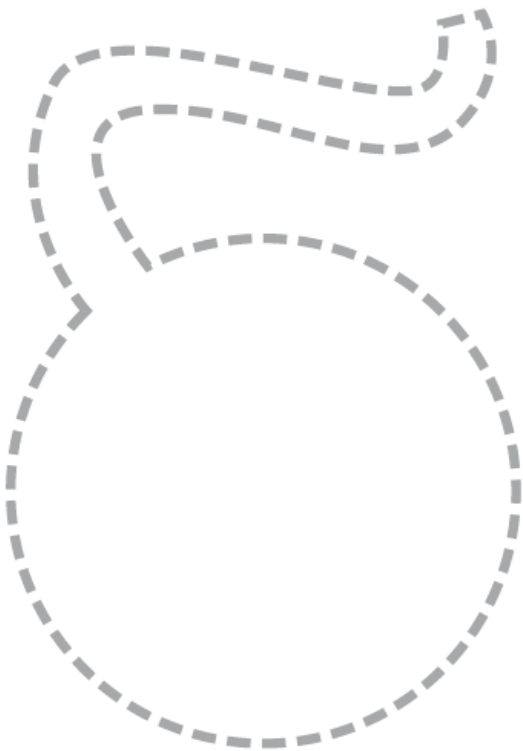
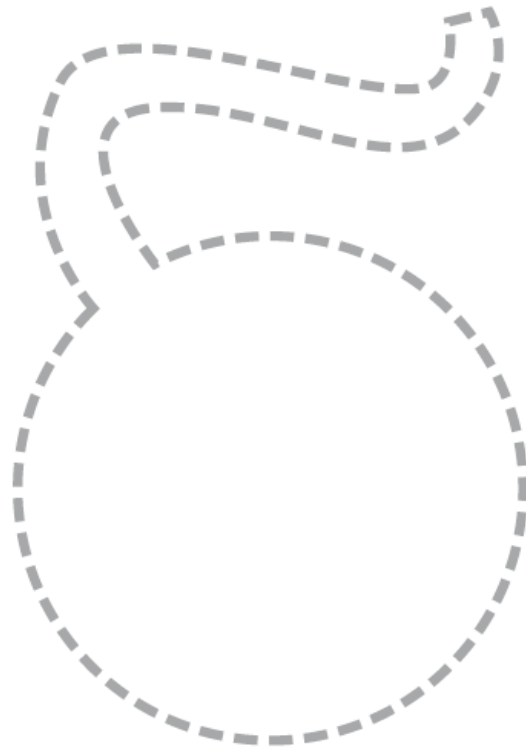
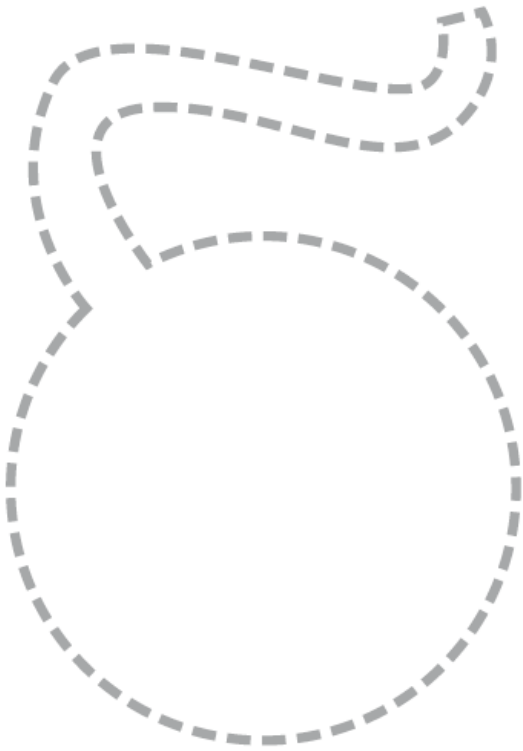

Aspa



Aspa



Espiral

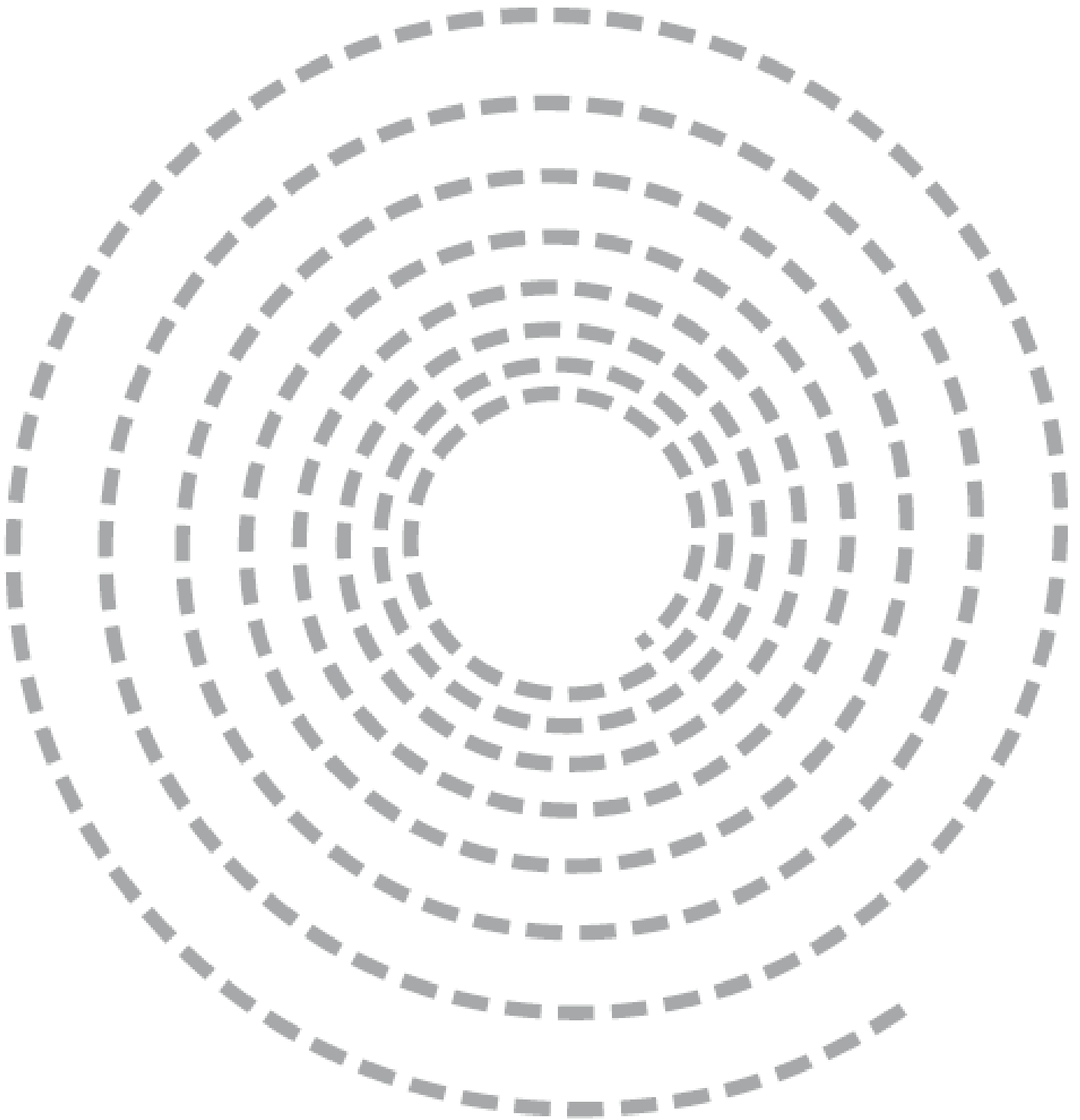

Espiral

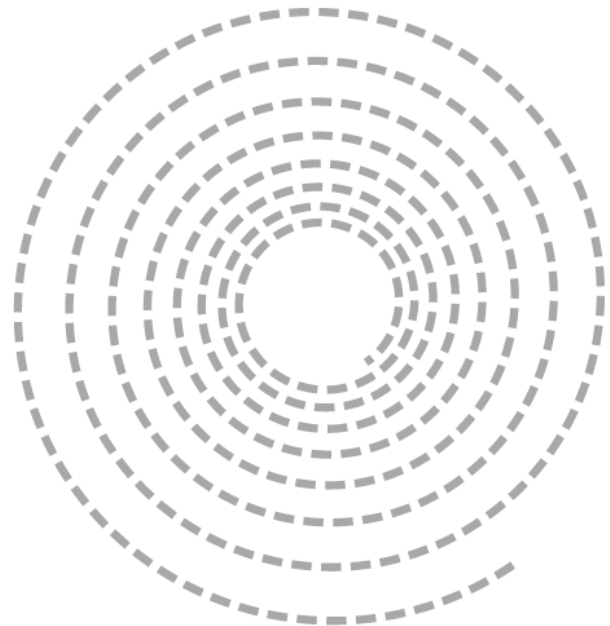
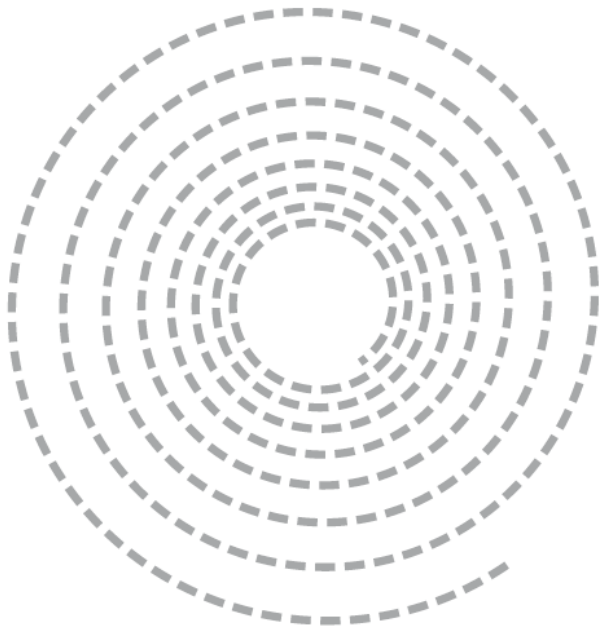
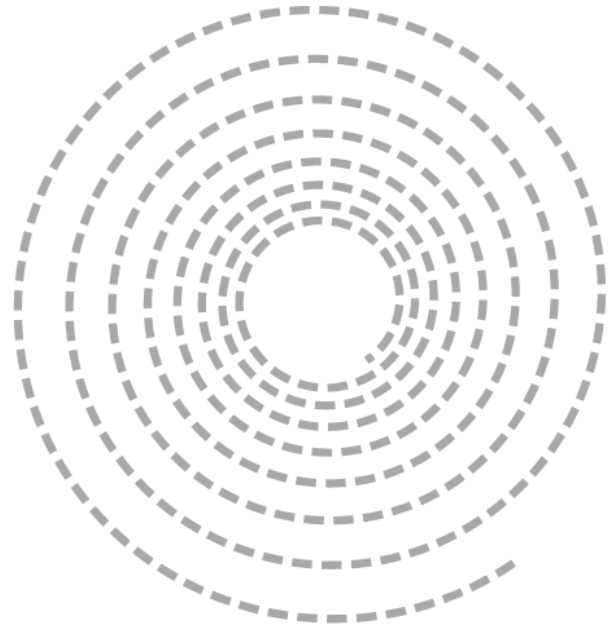
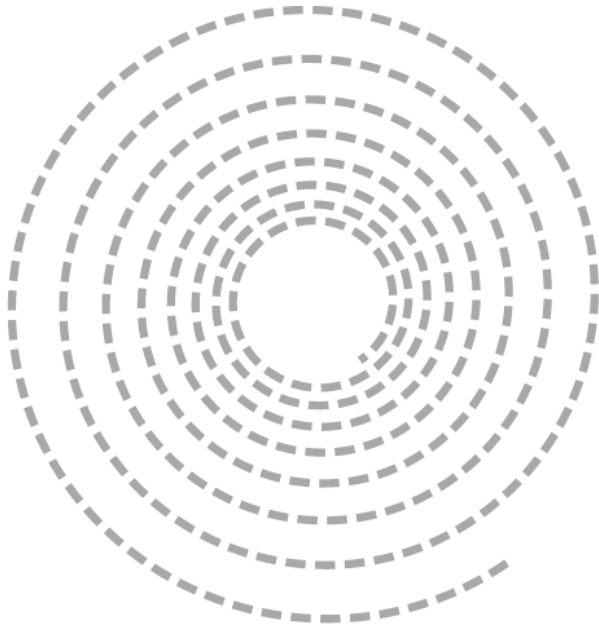

Luna

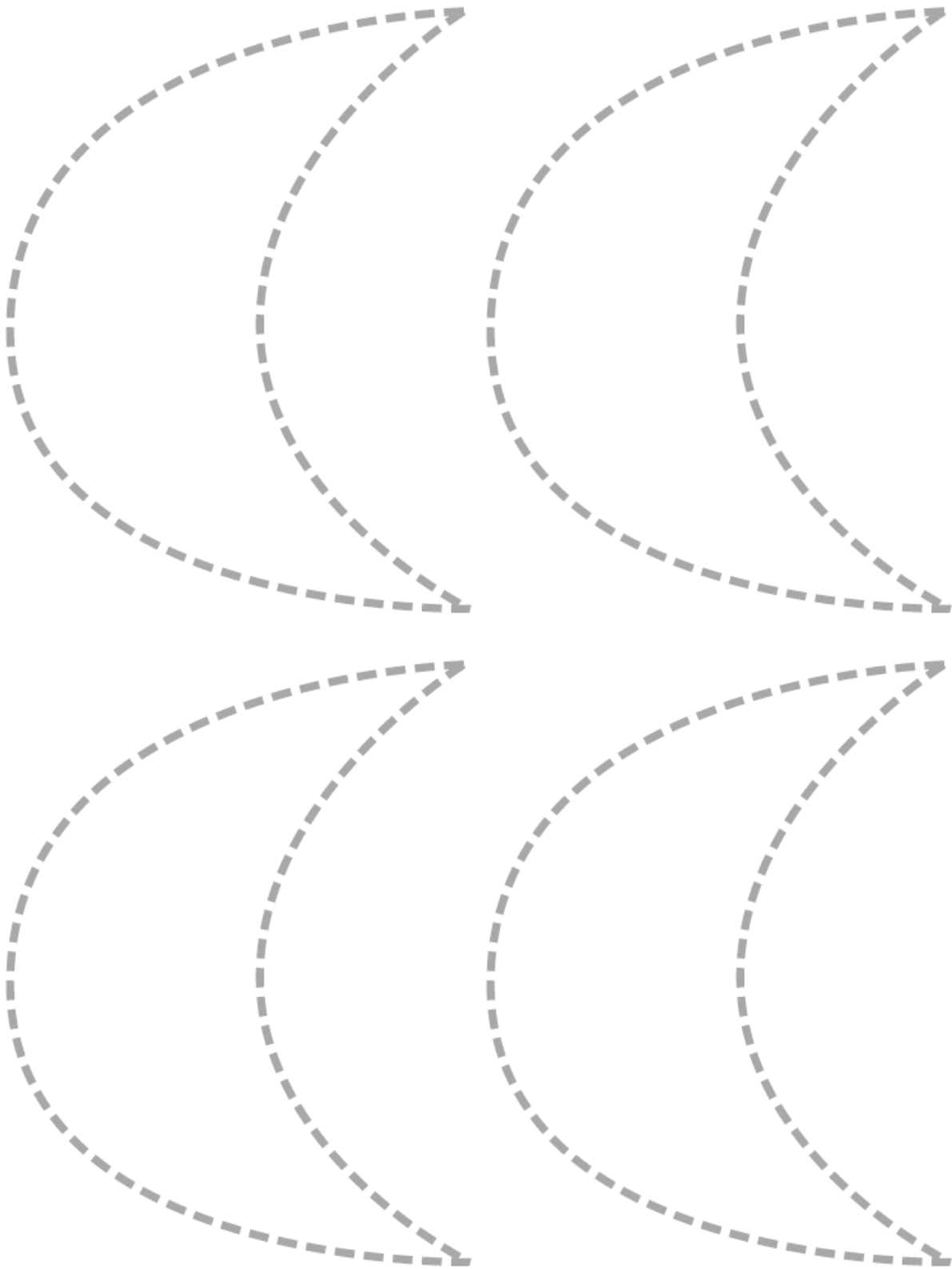

Luna

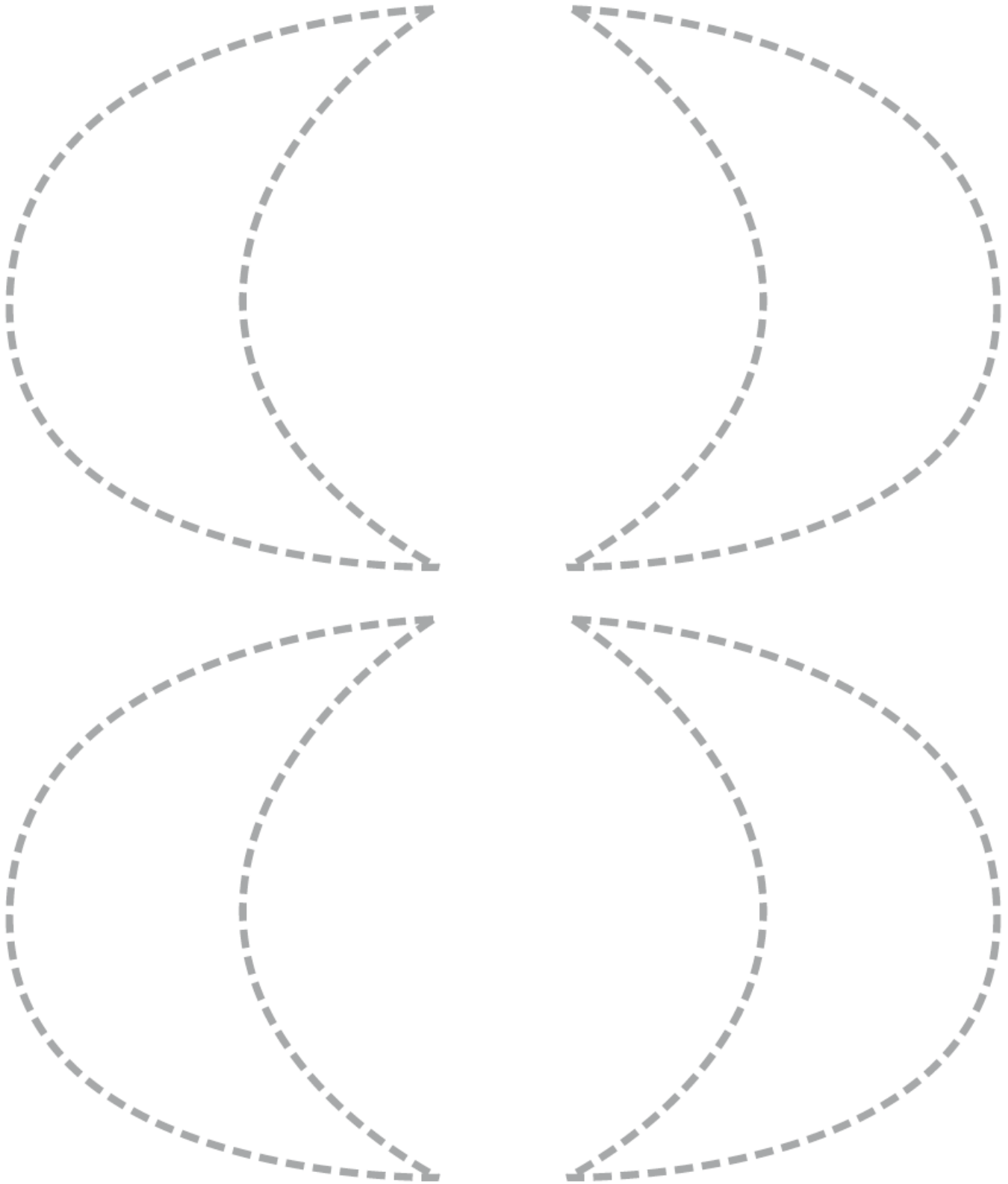

Flecha



Flecha

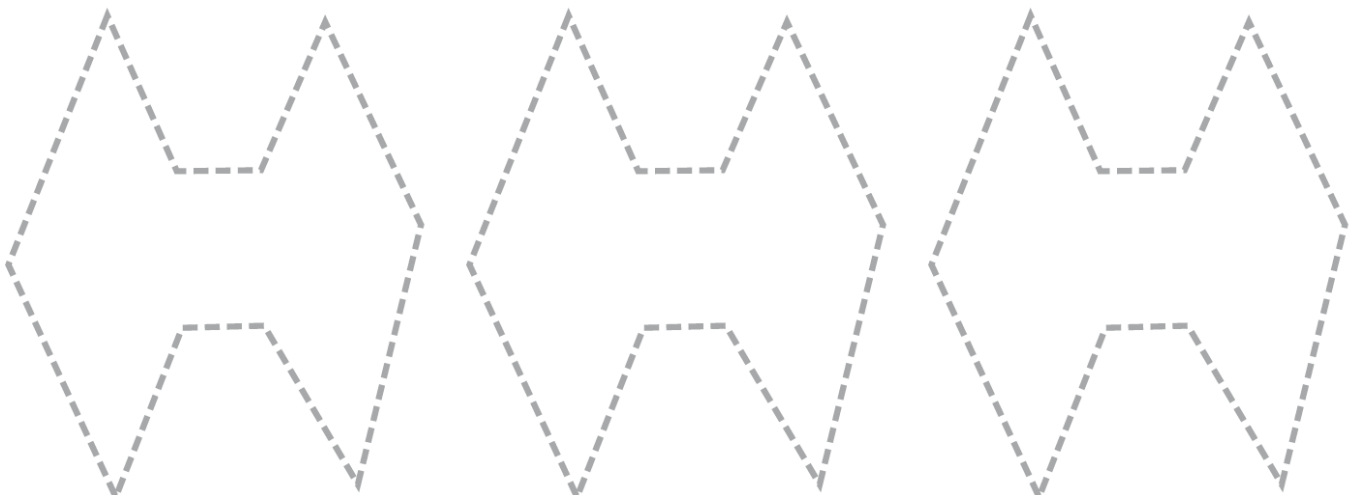
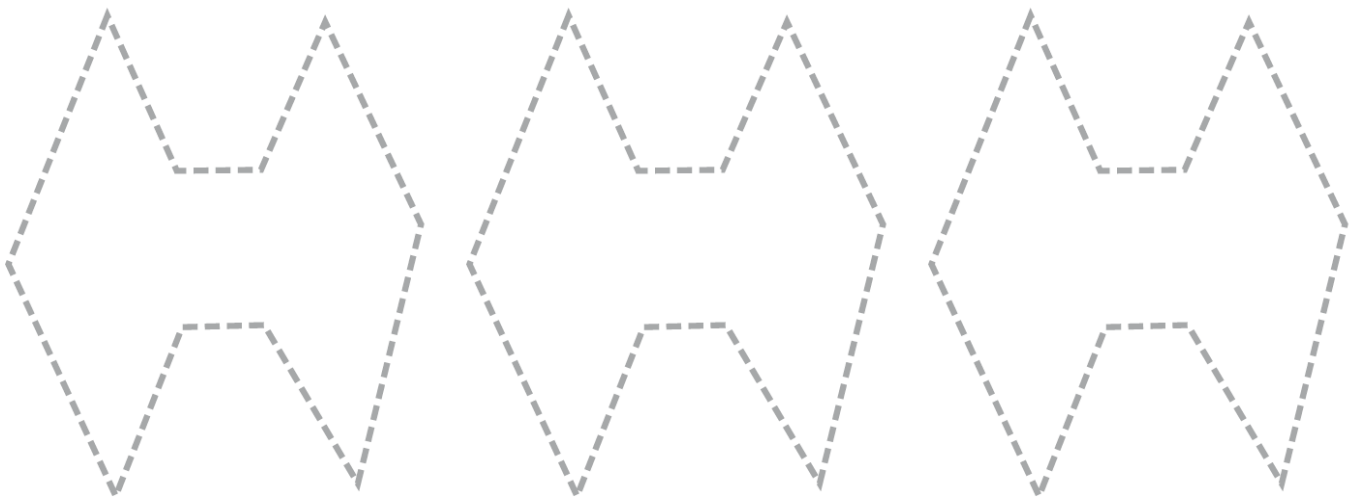
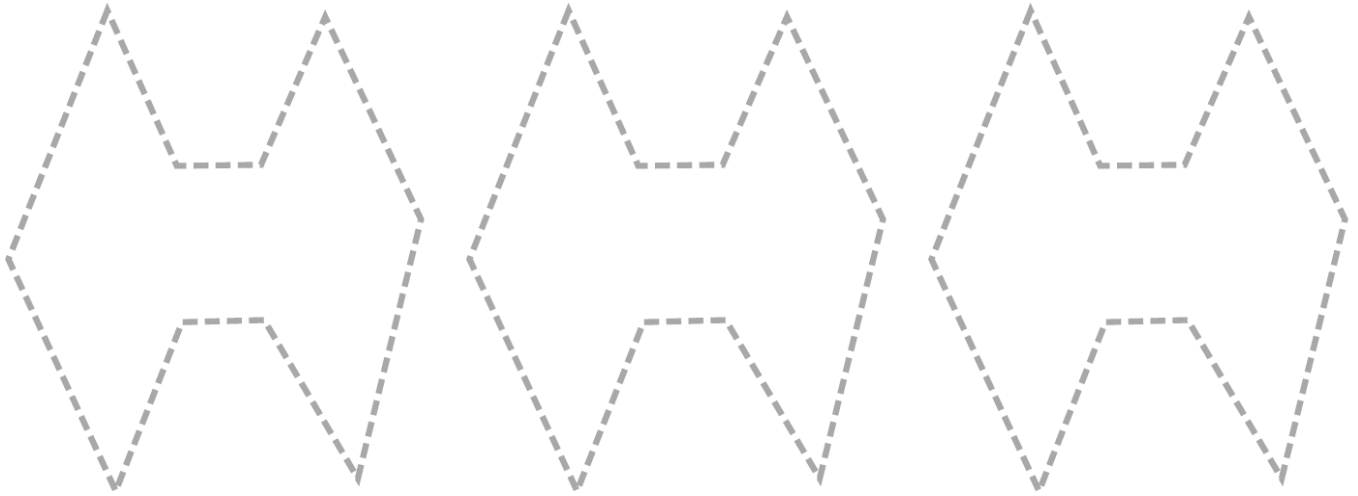

GRAFOMOTRICIDAD

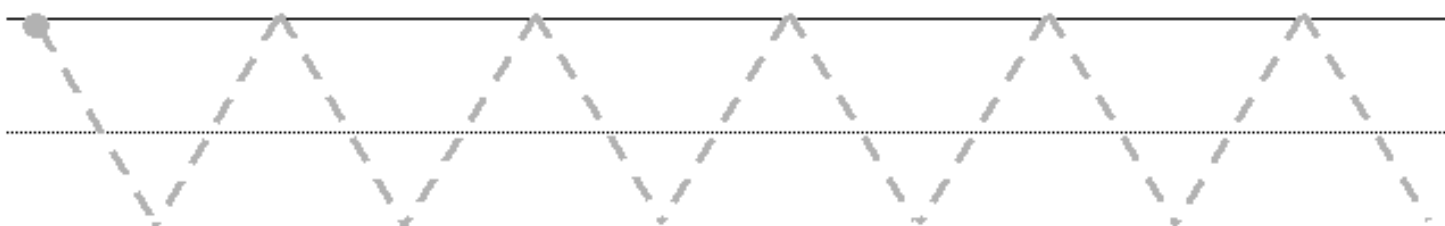
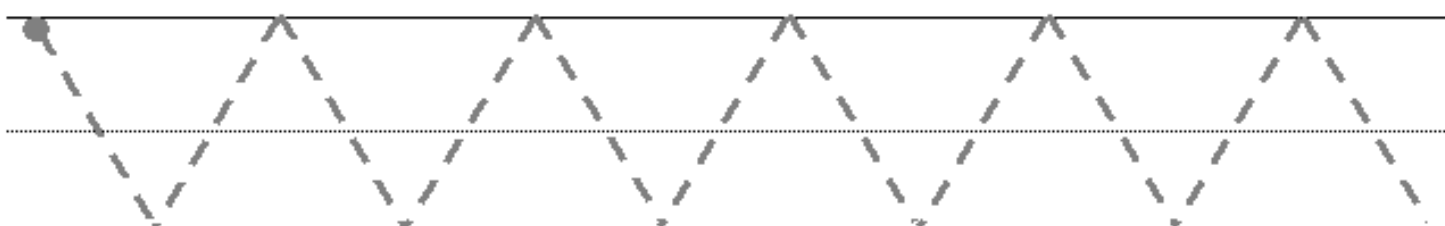
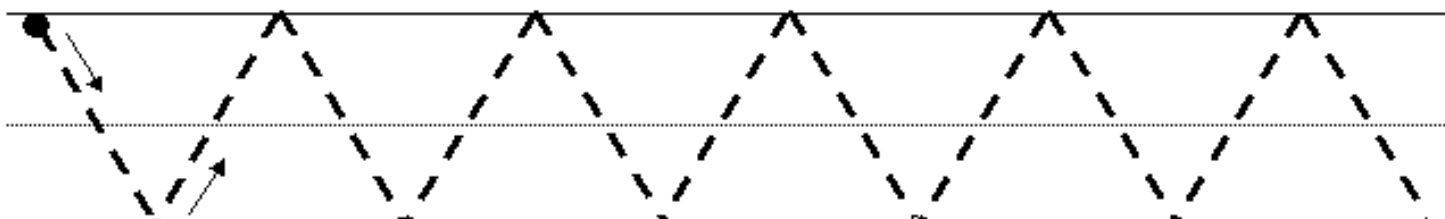
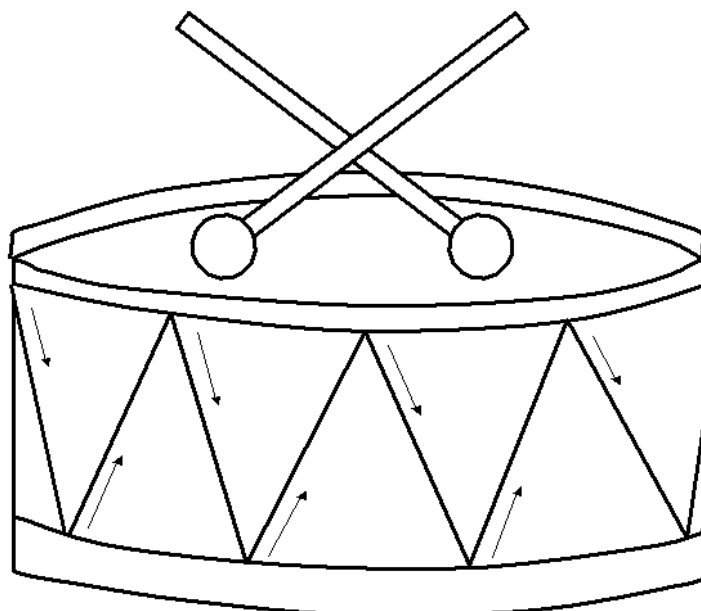

Más material en



<https://orientacionandujar.wordpress.com/>

GRAFOMOTRICIDAD

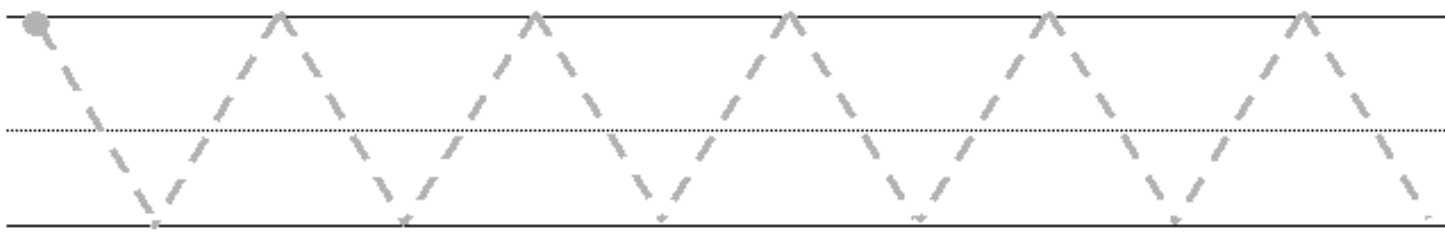
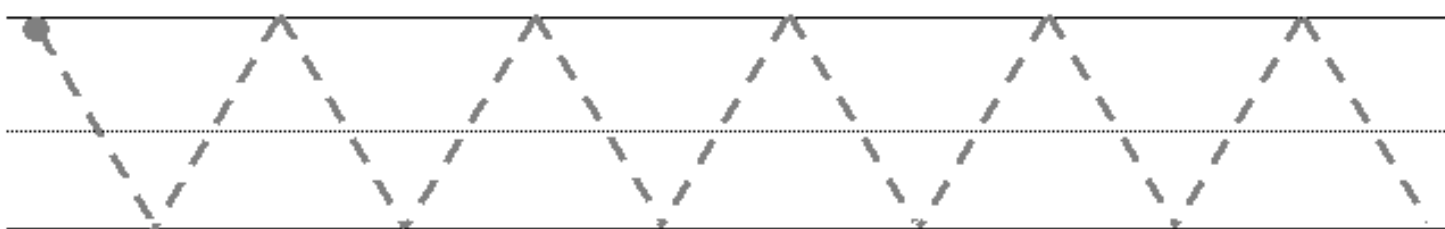
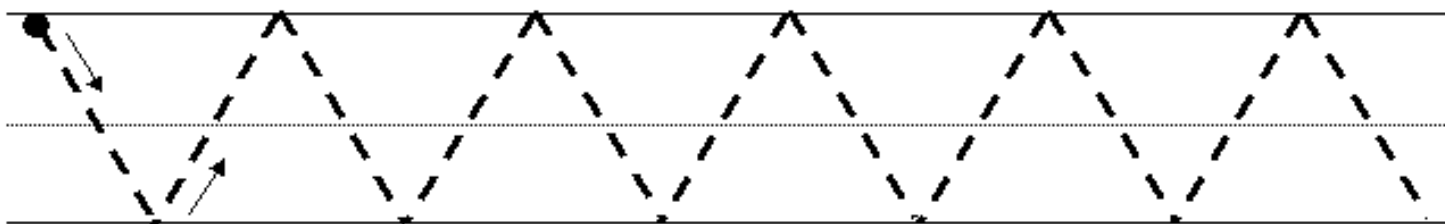
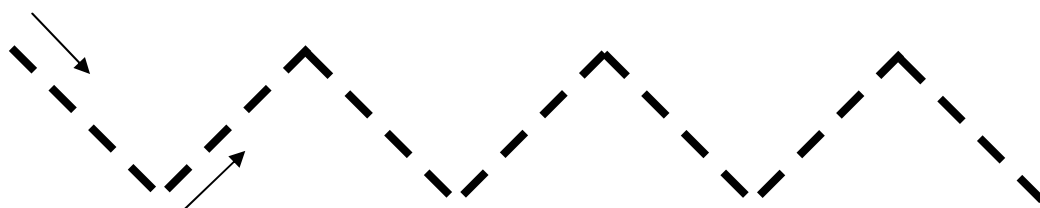
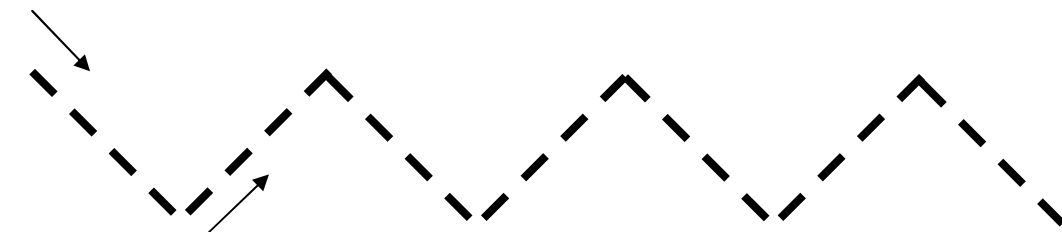

Más material en



<https://orientacionandujar.wordpress.com/>

GRAFOMOTRICIDAD

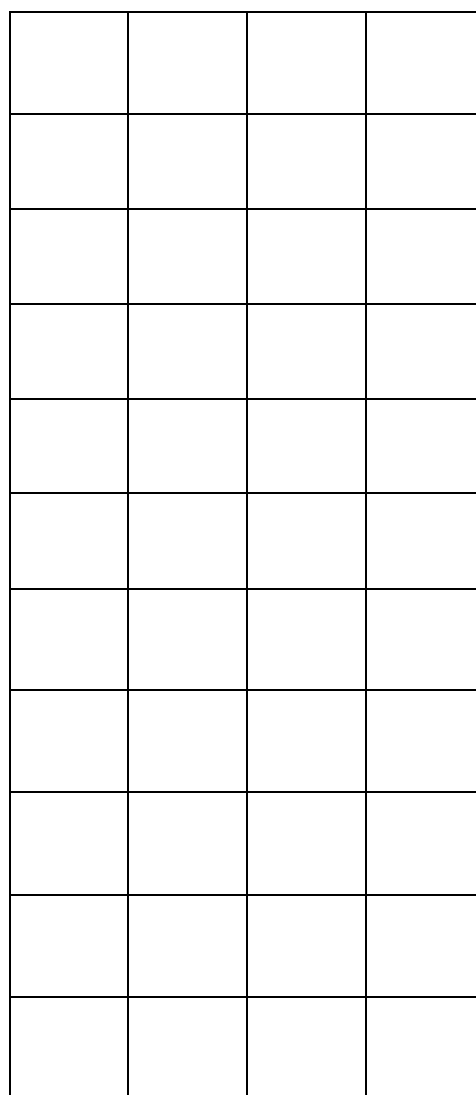
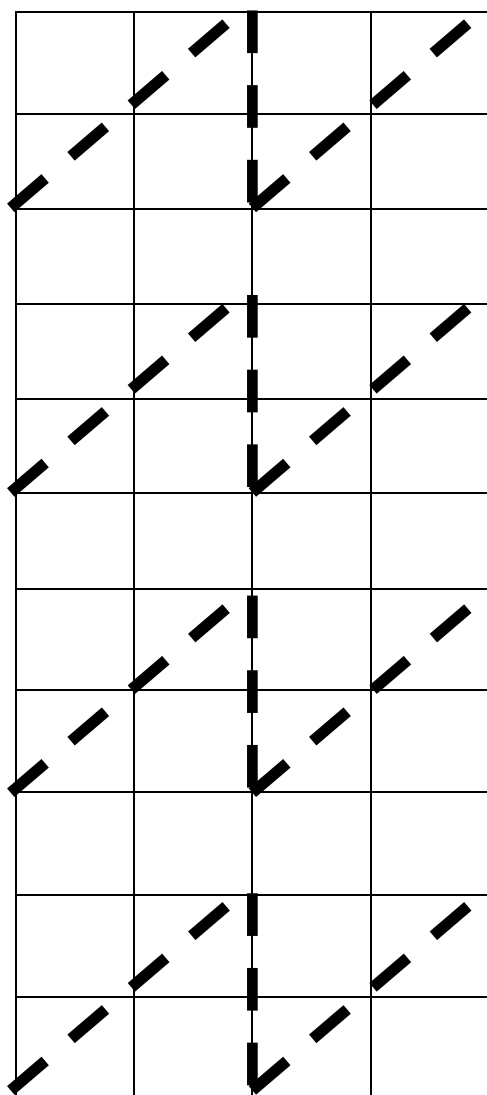
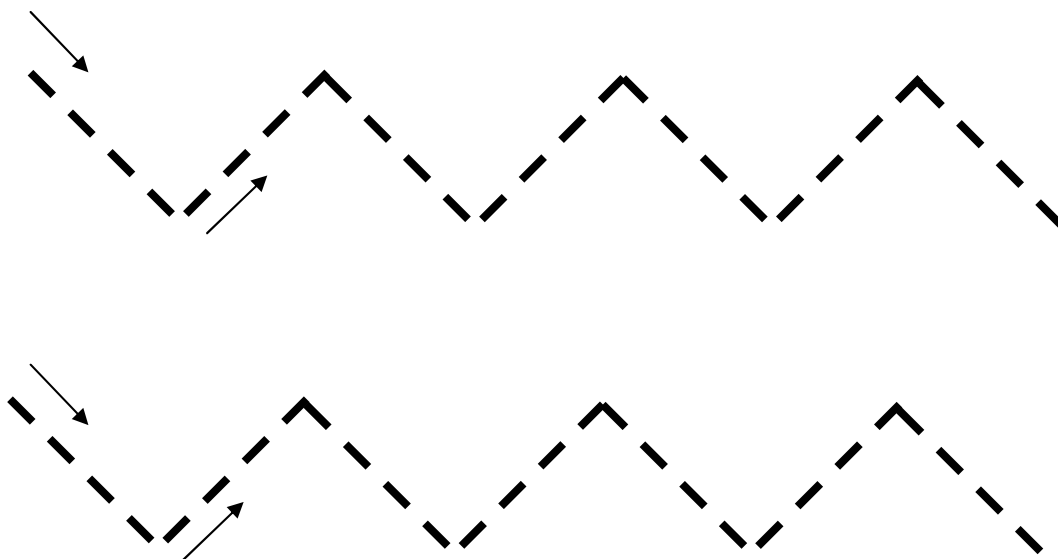

Más material en



<https://orientacionandujar.wordpress.com/>

GRAFOMOTRICIDAD

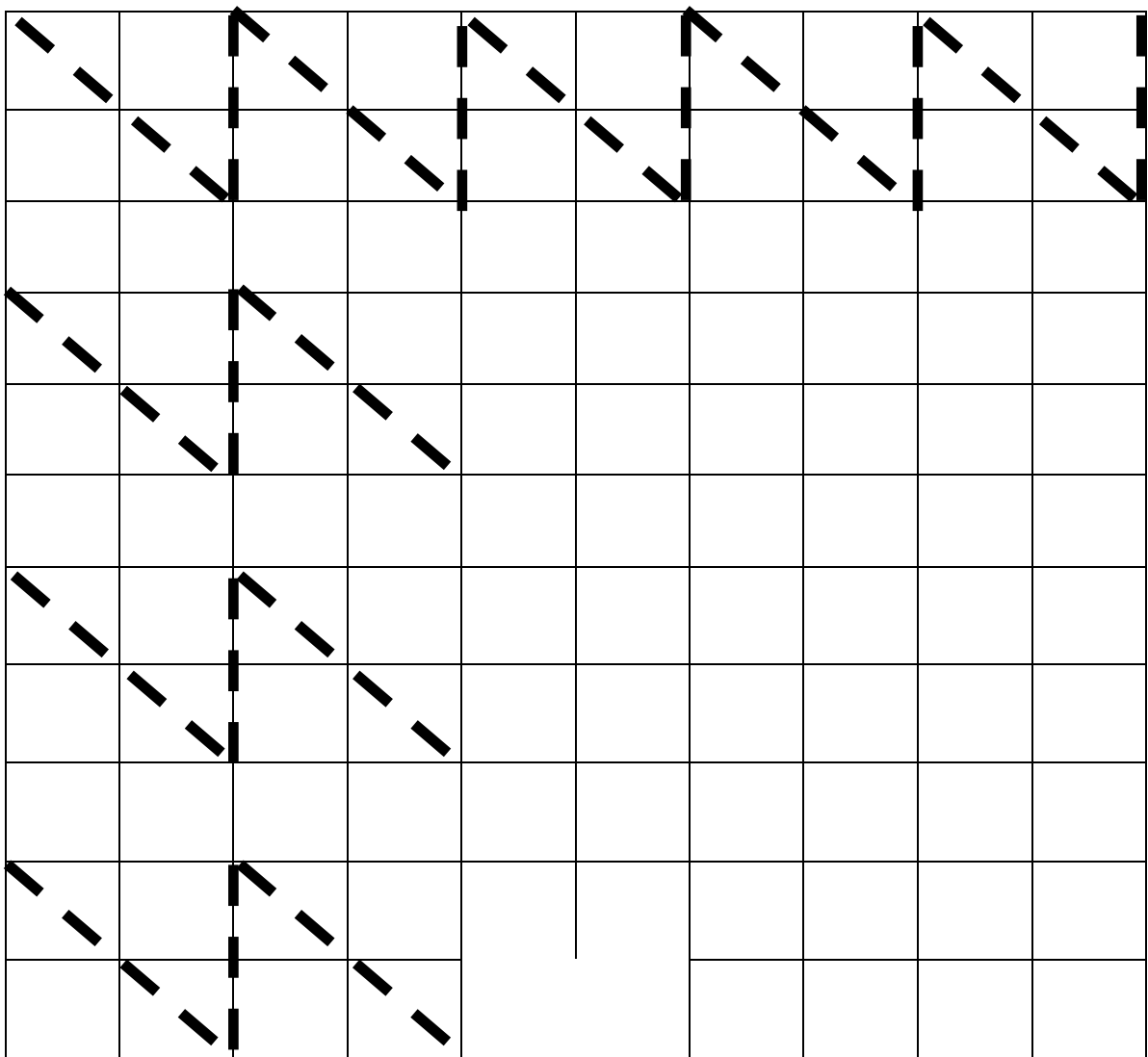
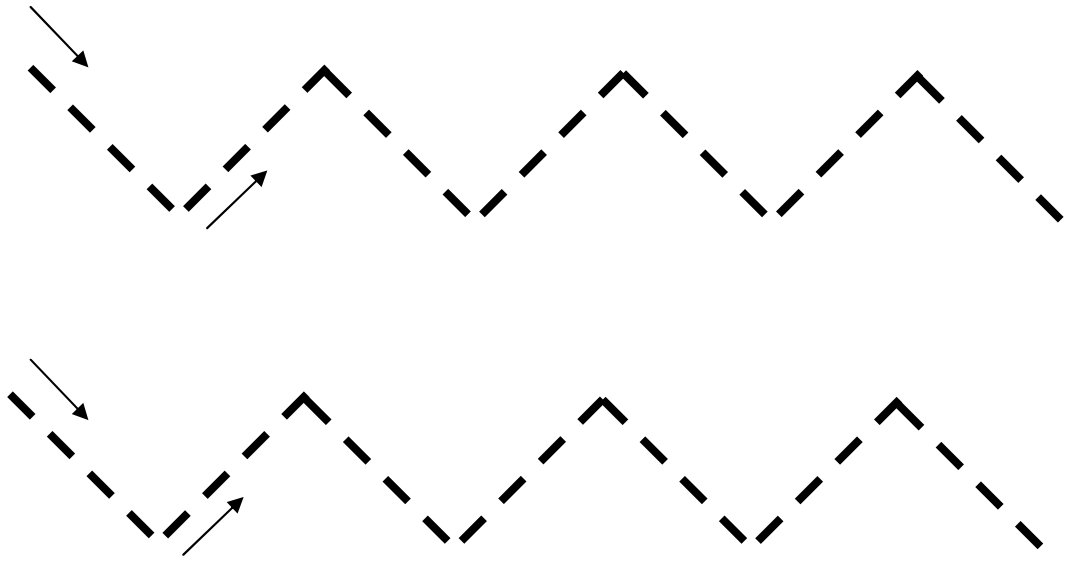

GRAFOMOTRICIDAD

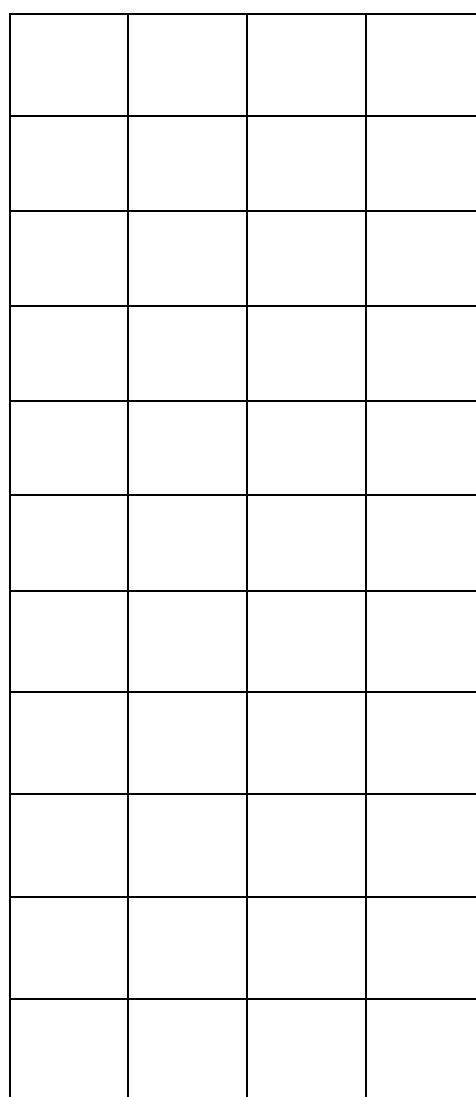
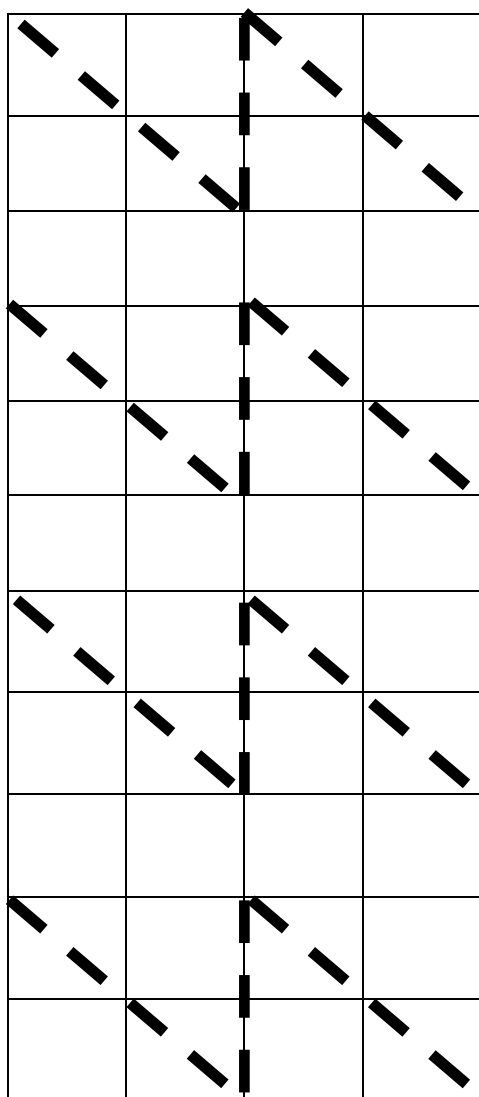
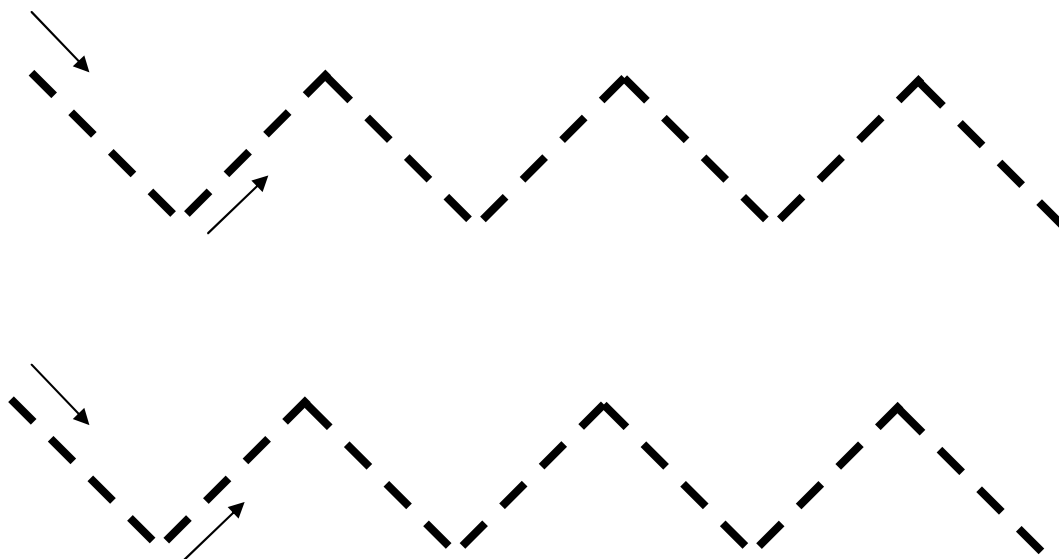

Más material en



<https://orientacionandujar.wordpress.com/>

GRAFOMOTRICIDAD

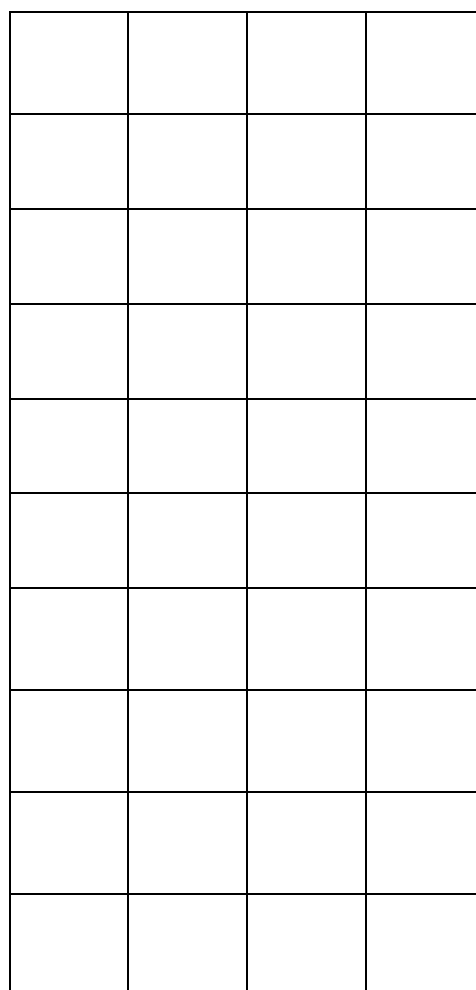
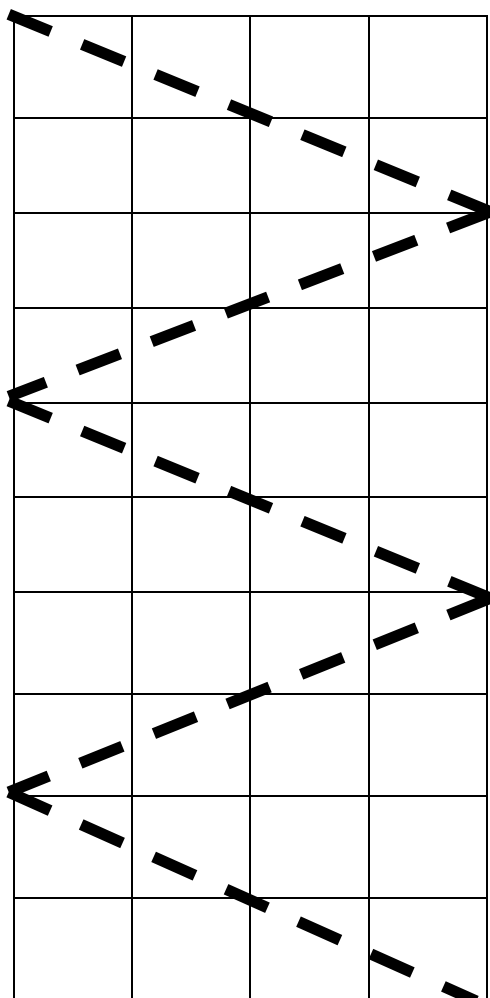
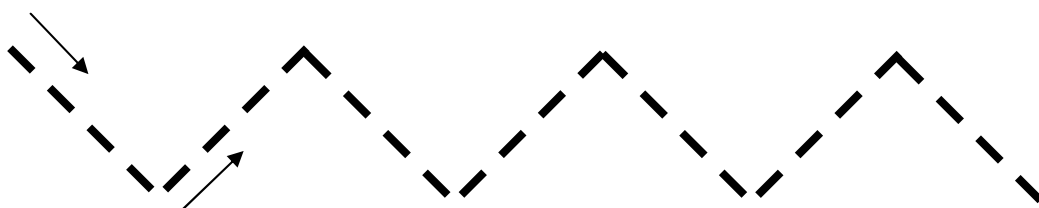
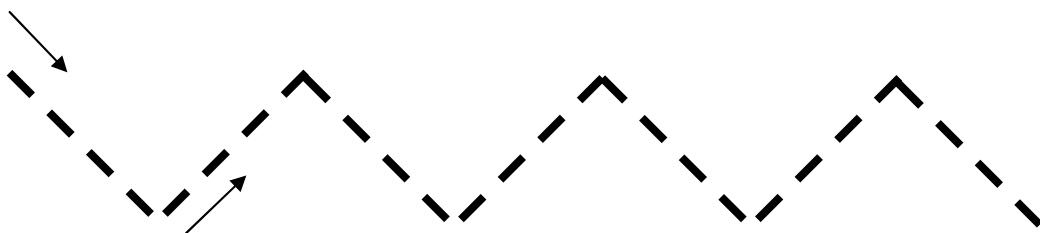

GRAFOMOTRICIDAD

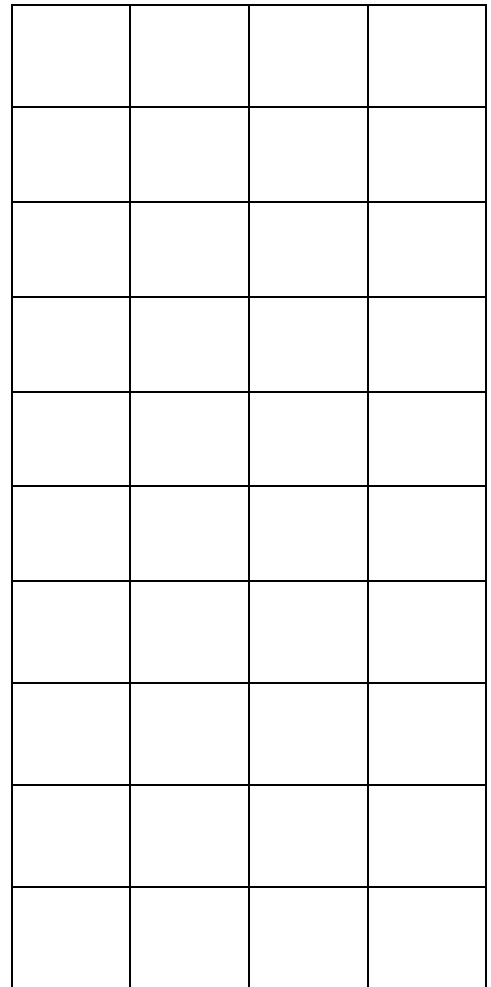
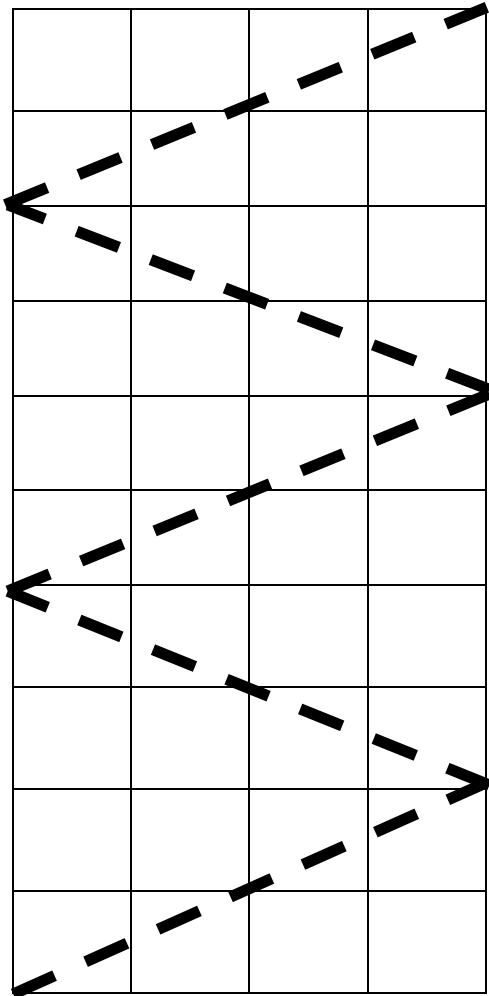
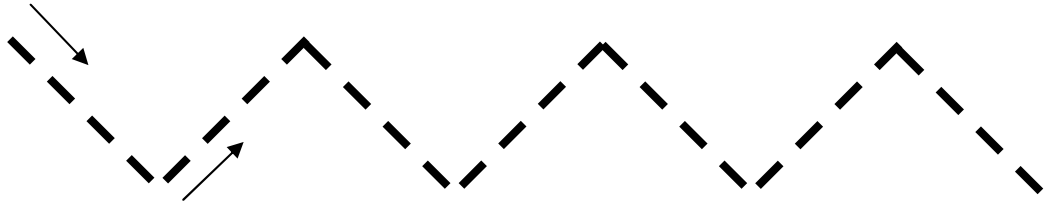
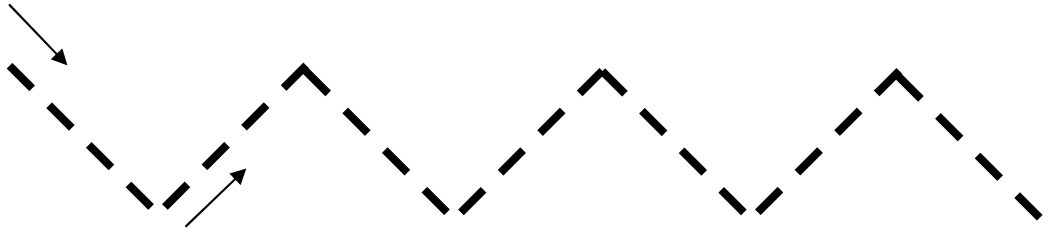

GRAFOMOTRICIDAD

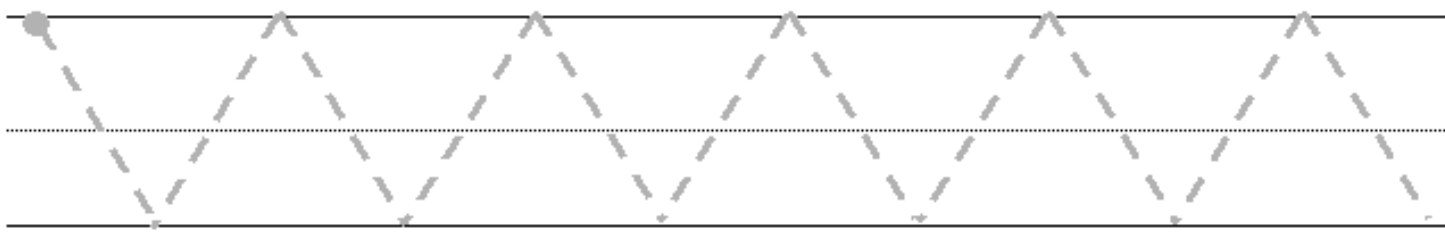
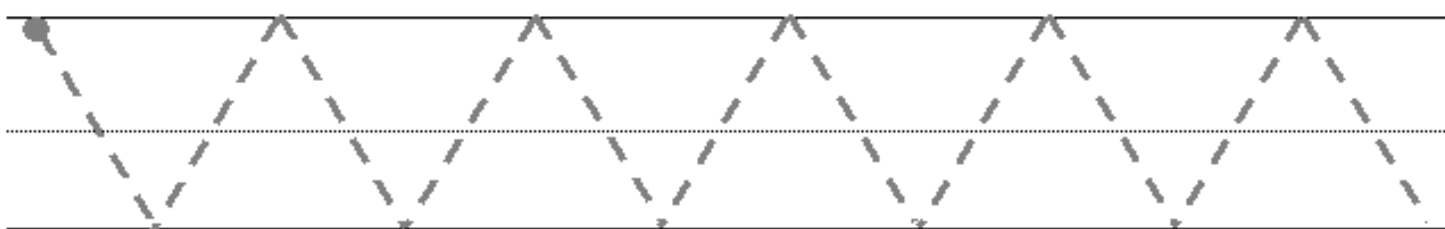
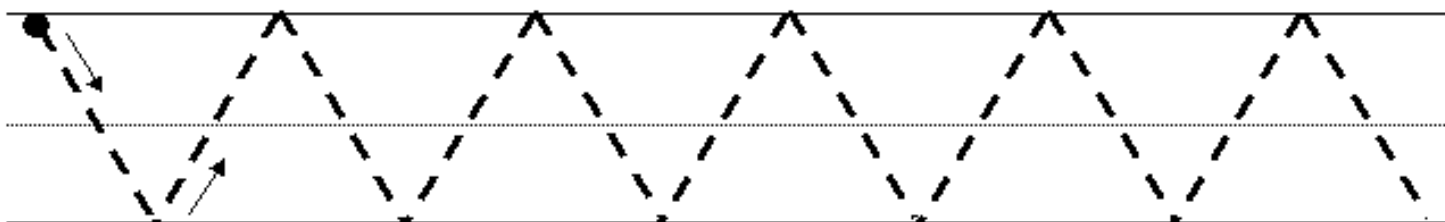
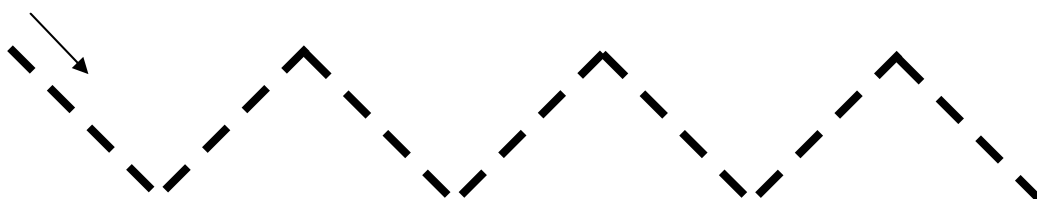
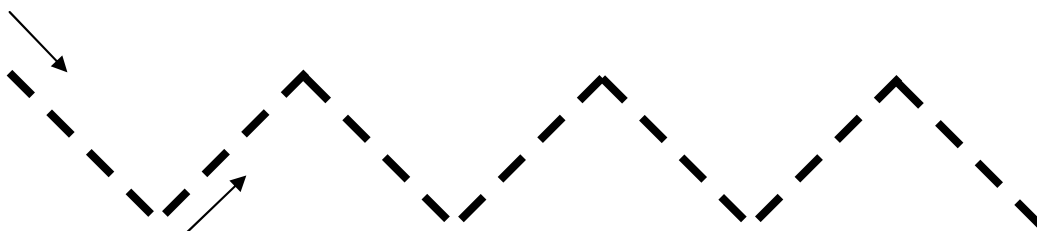

Más material en



<https://orientacionandujar.wordpress.com/>

GRAFOMOTRICIDAD

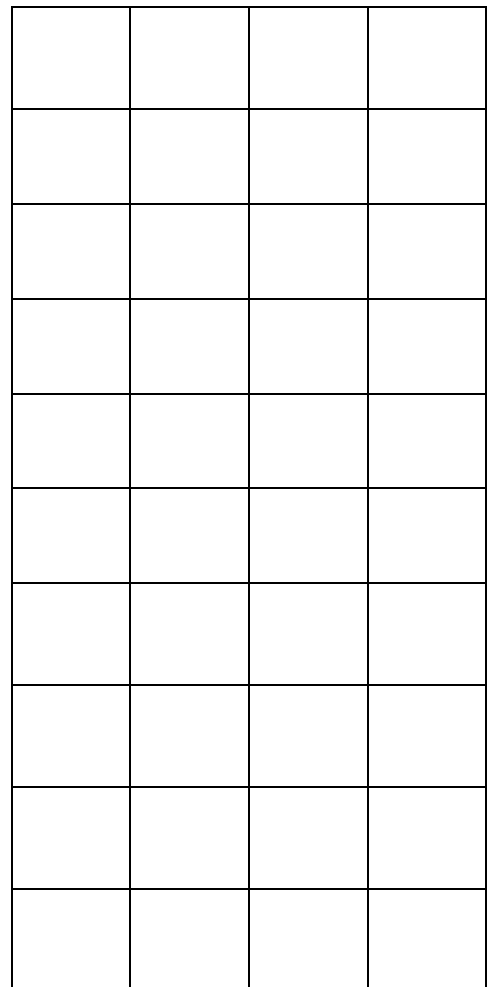
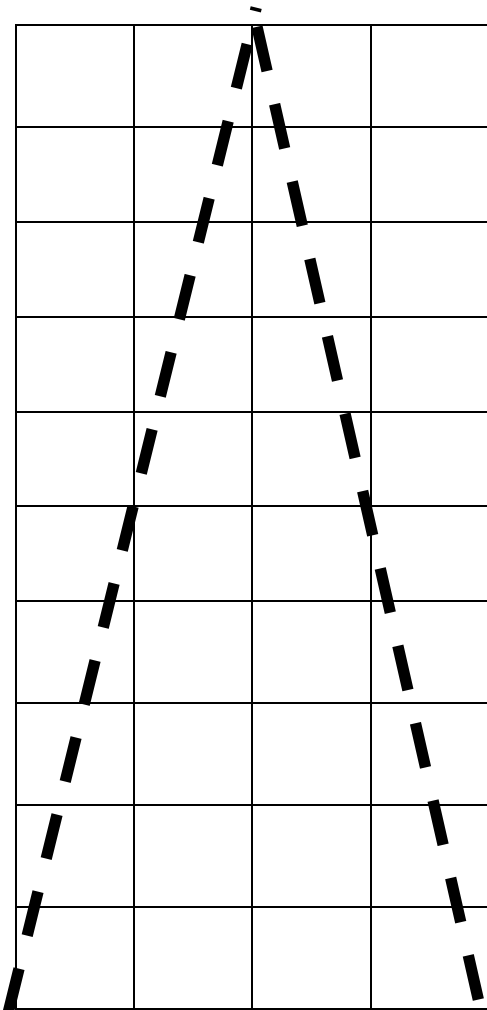
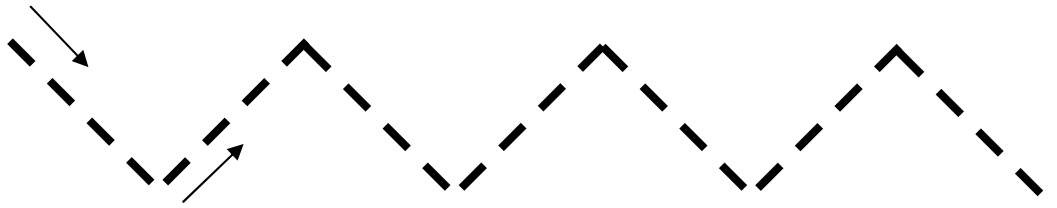
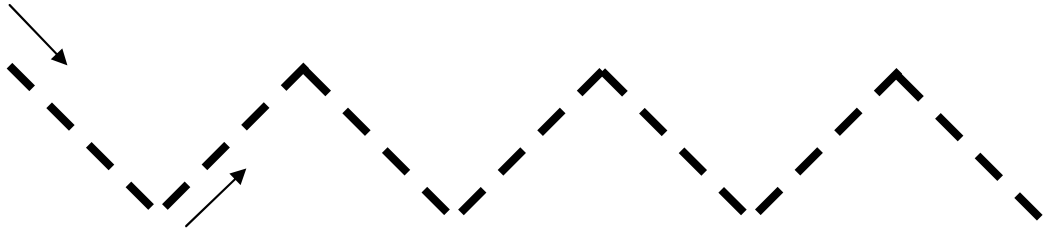

GRAFOMOTRICIDAD

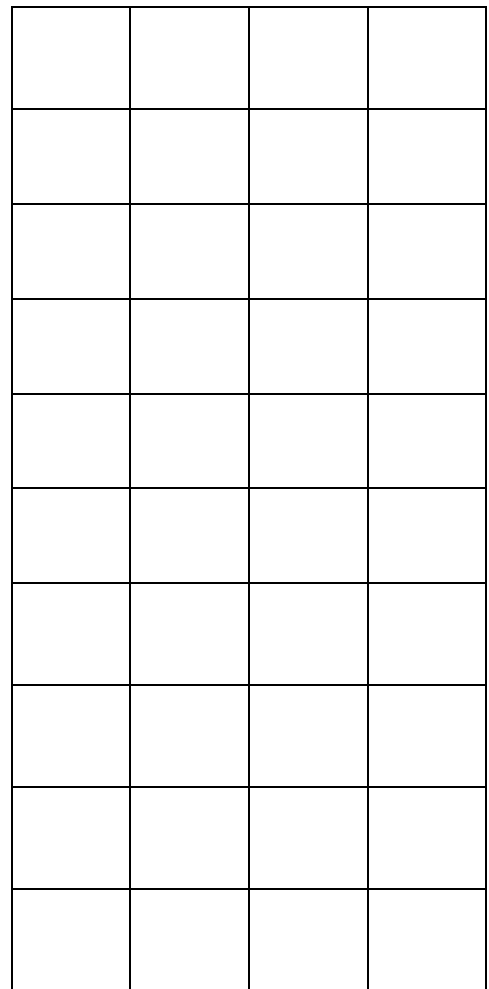
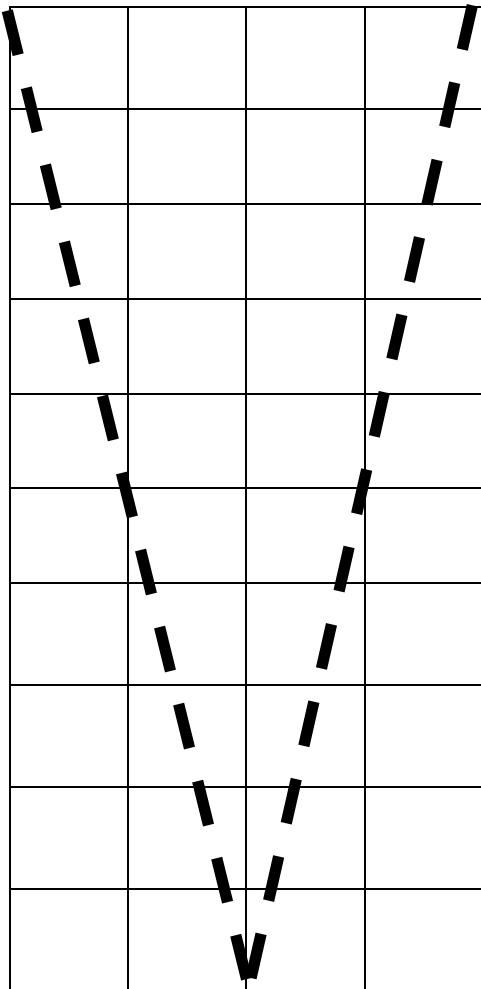
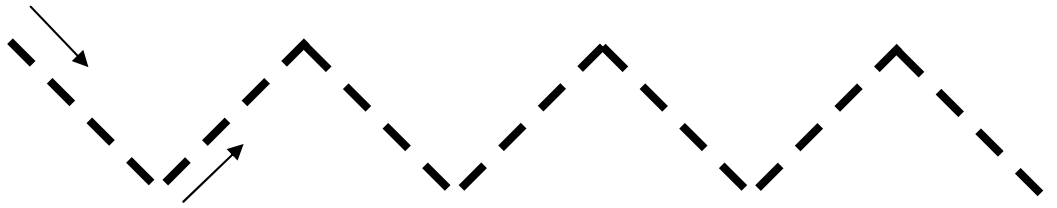
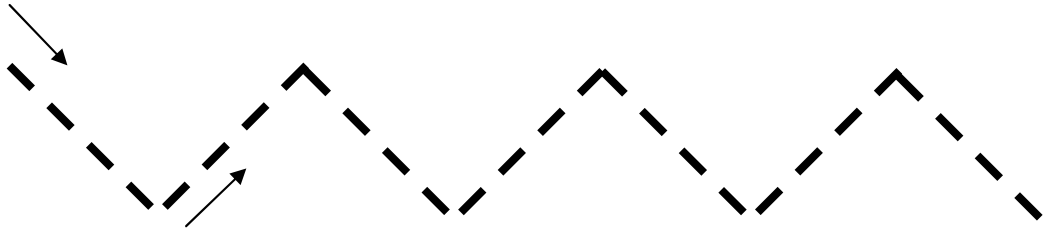

GRAFOMOTRICIDAD

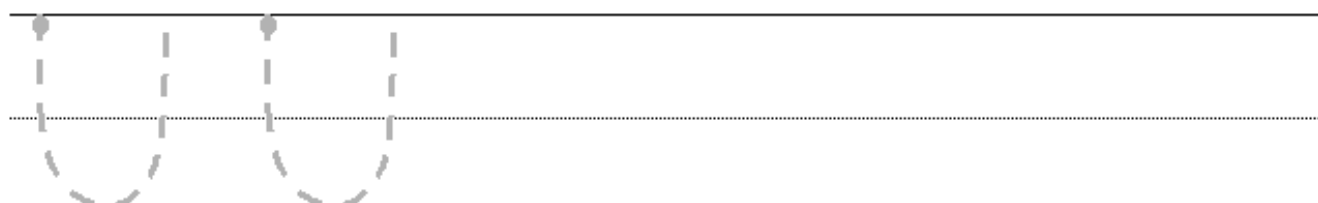
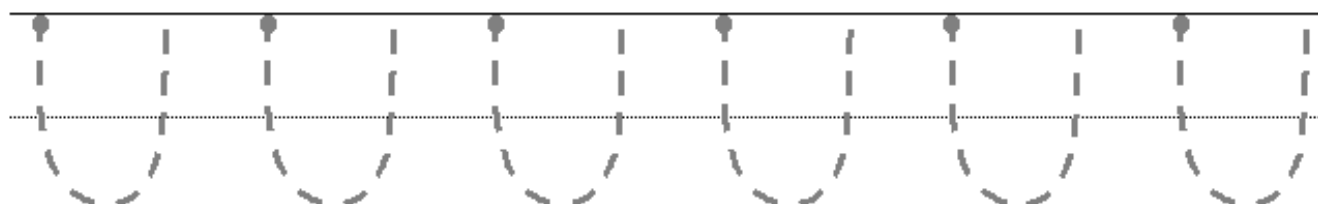
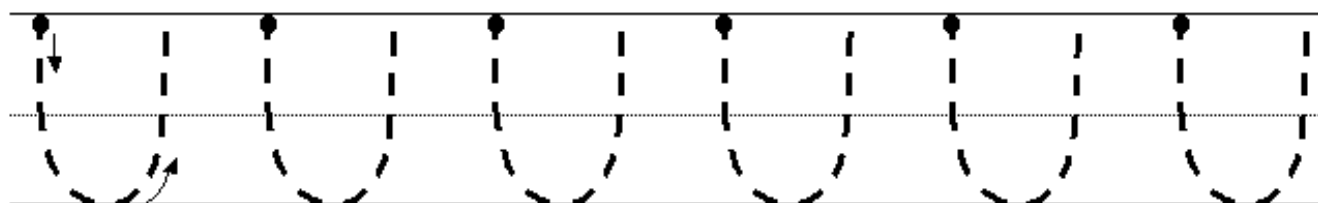
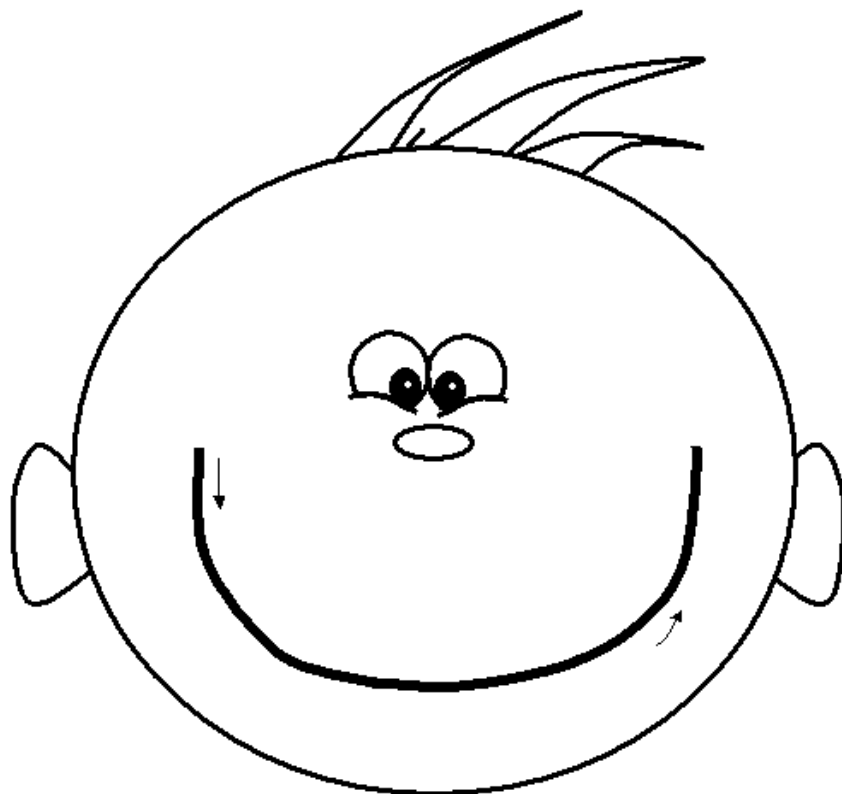

Más material en



<http://orientacionandujar.wordpress.com/>

GRAFOMOTRICIDAD

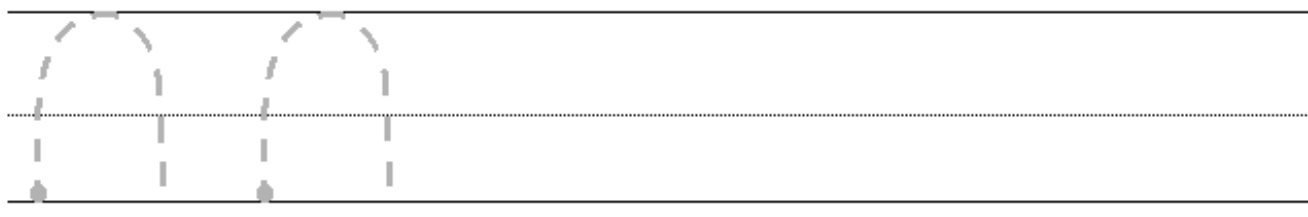
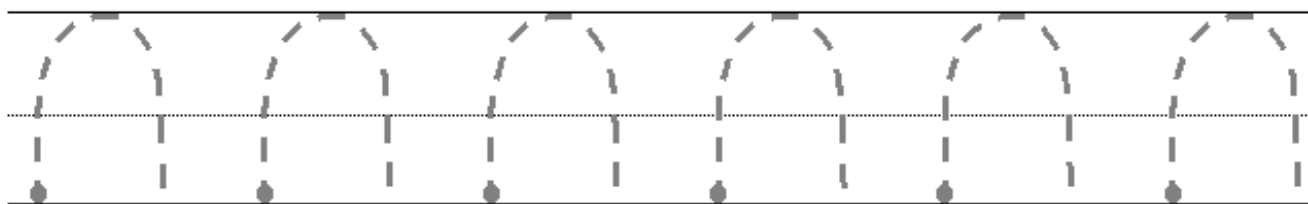
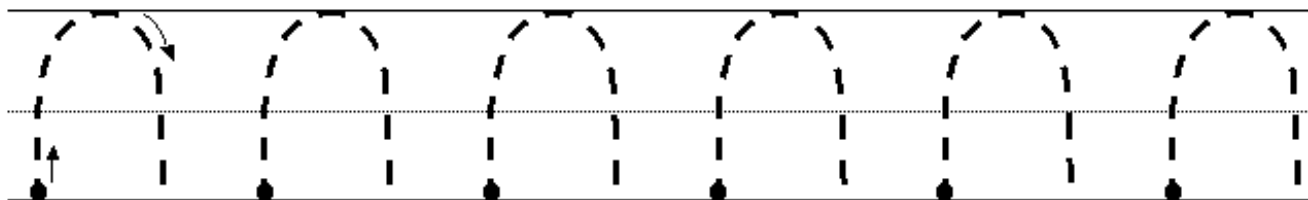
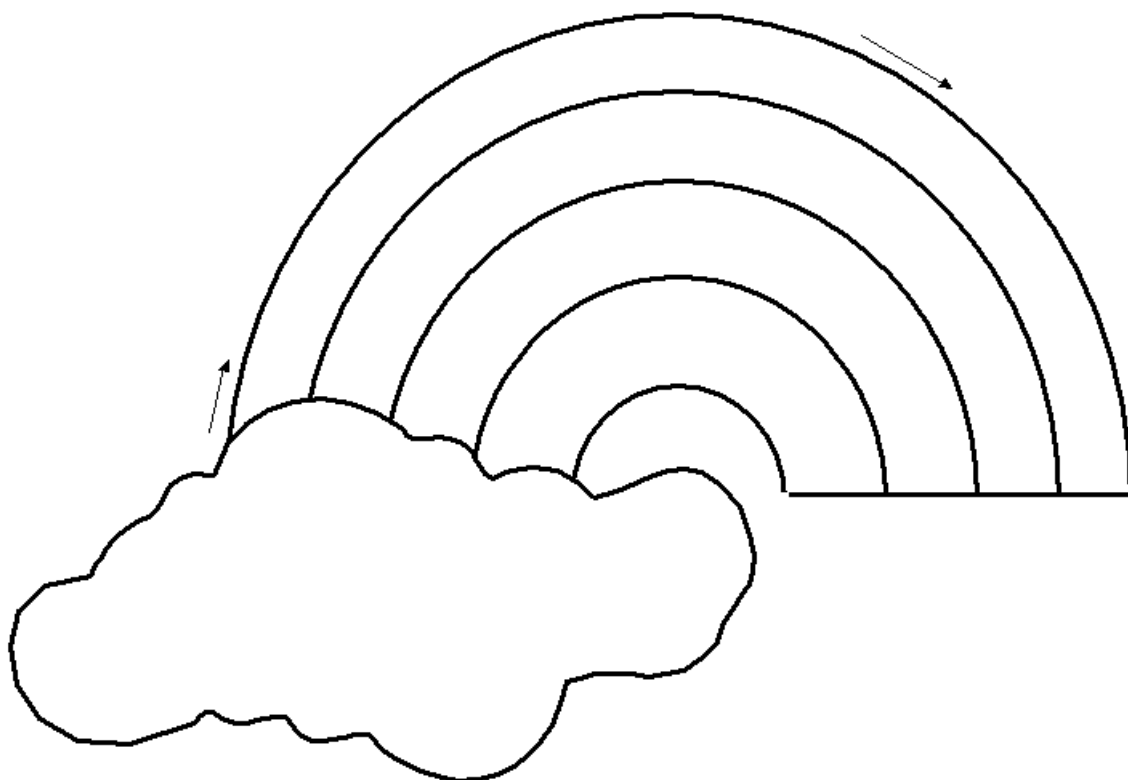

Más material en



<http://orientacionandujar.wordpress.com/>

GRAFOMOTRICIDAD

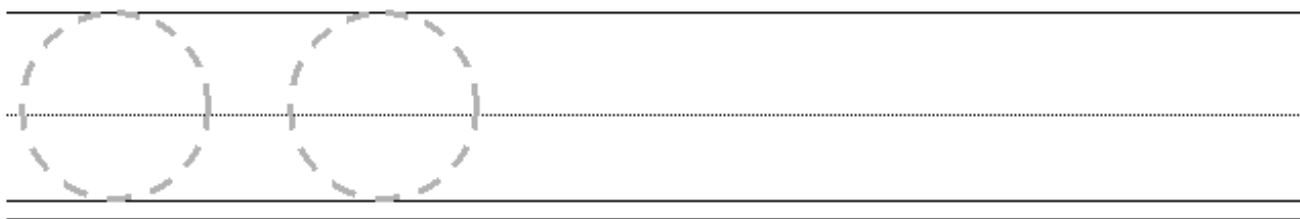
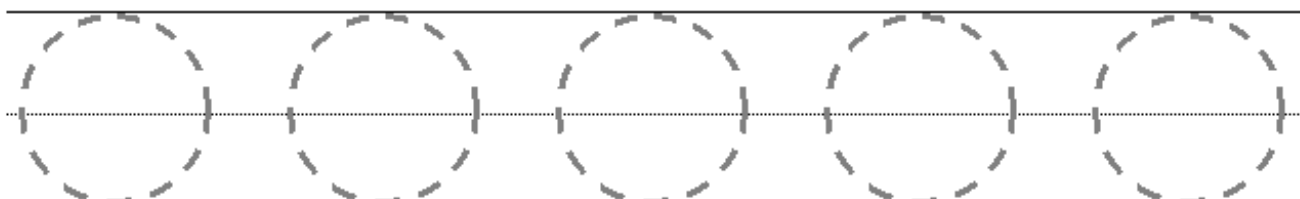
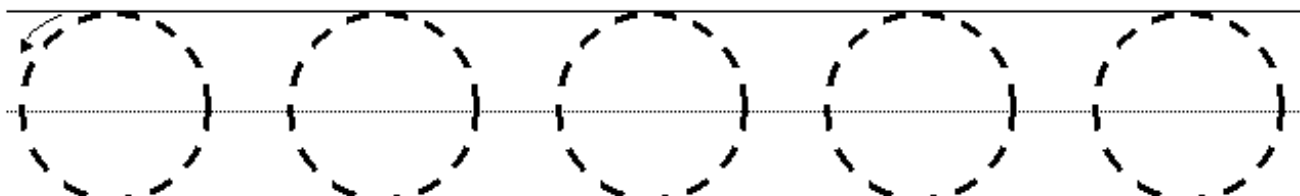
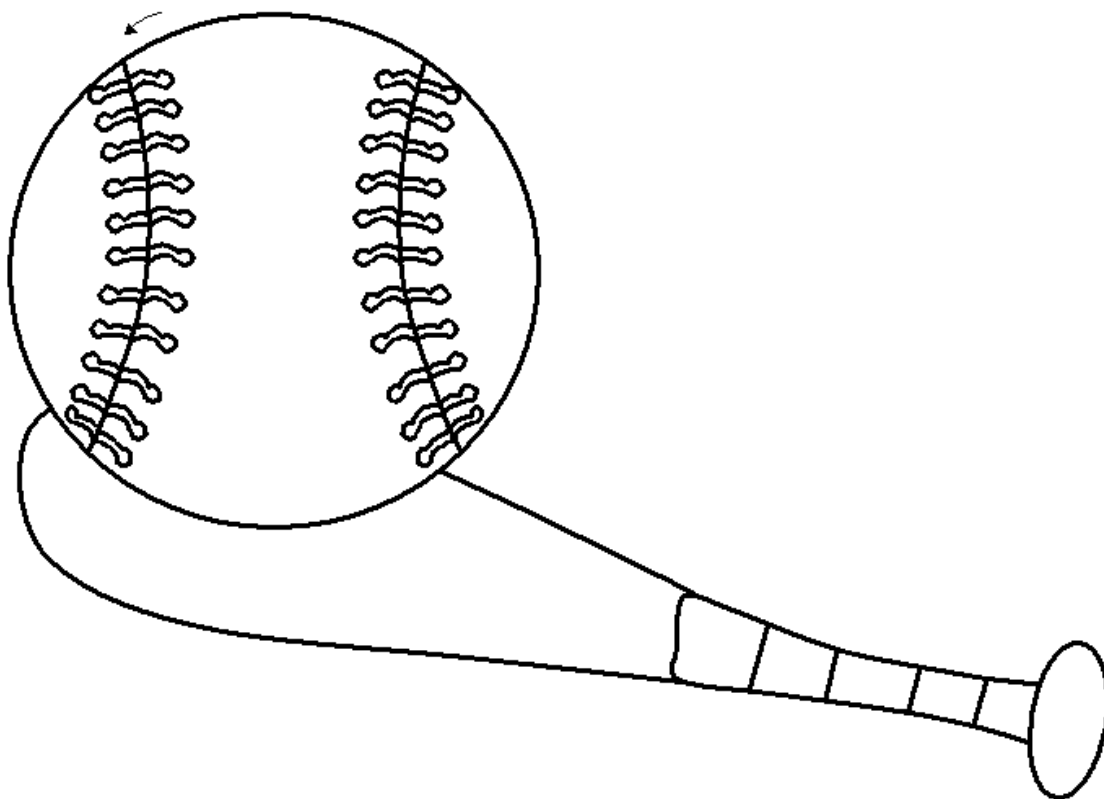

Más material en



<http://orientacionandujar.wordpress.com/>

GRAFOMOTRICIDAD

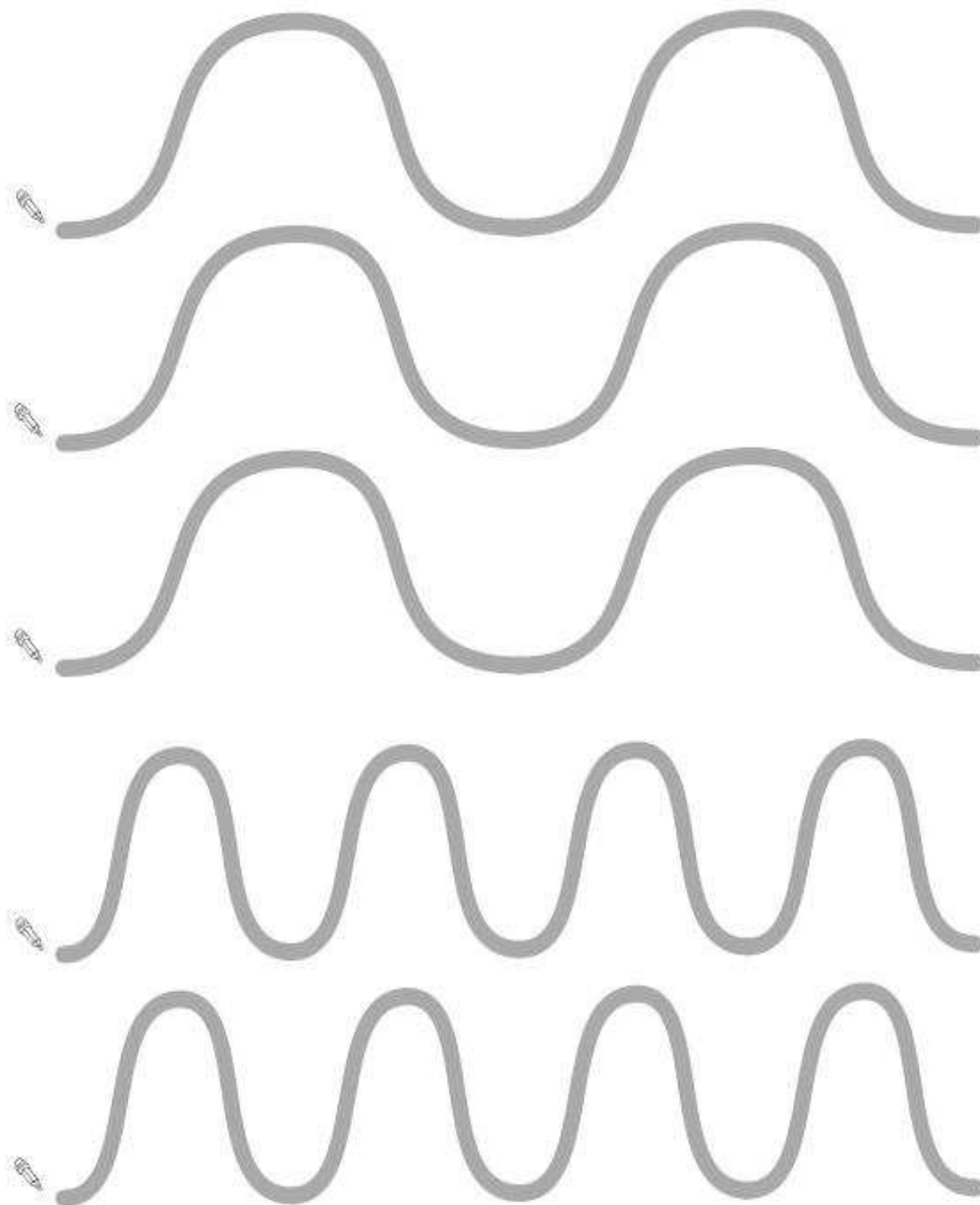

GRAFOMOTRICIDAD

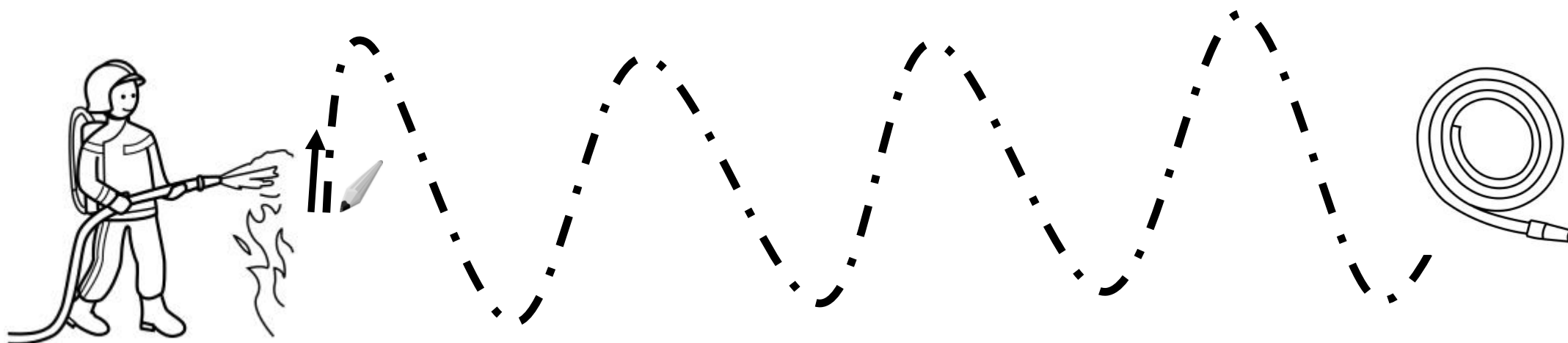
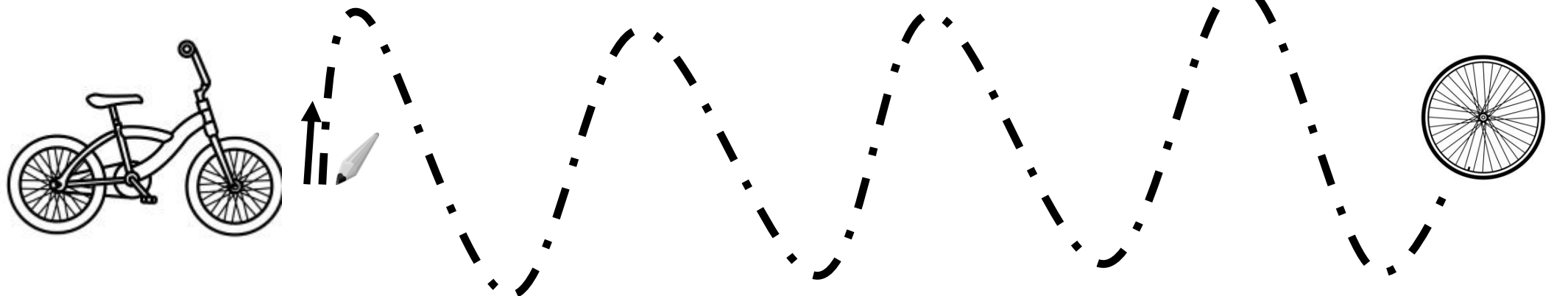

GRAFOMOTRICIDAD

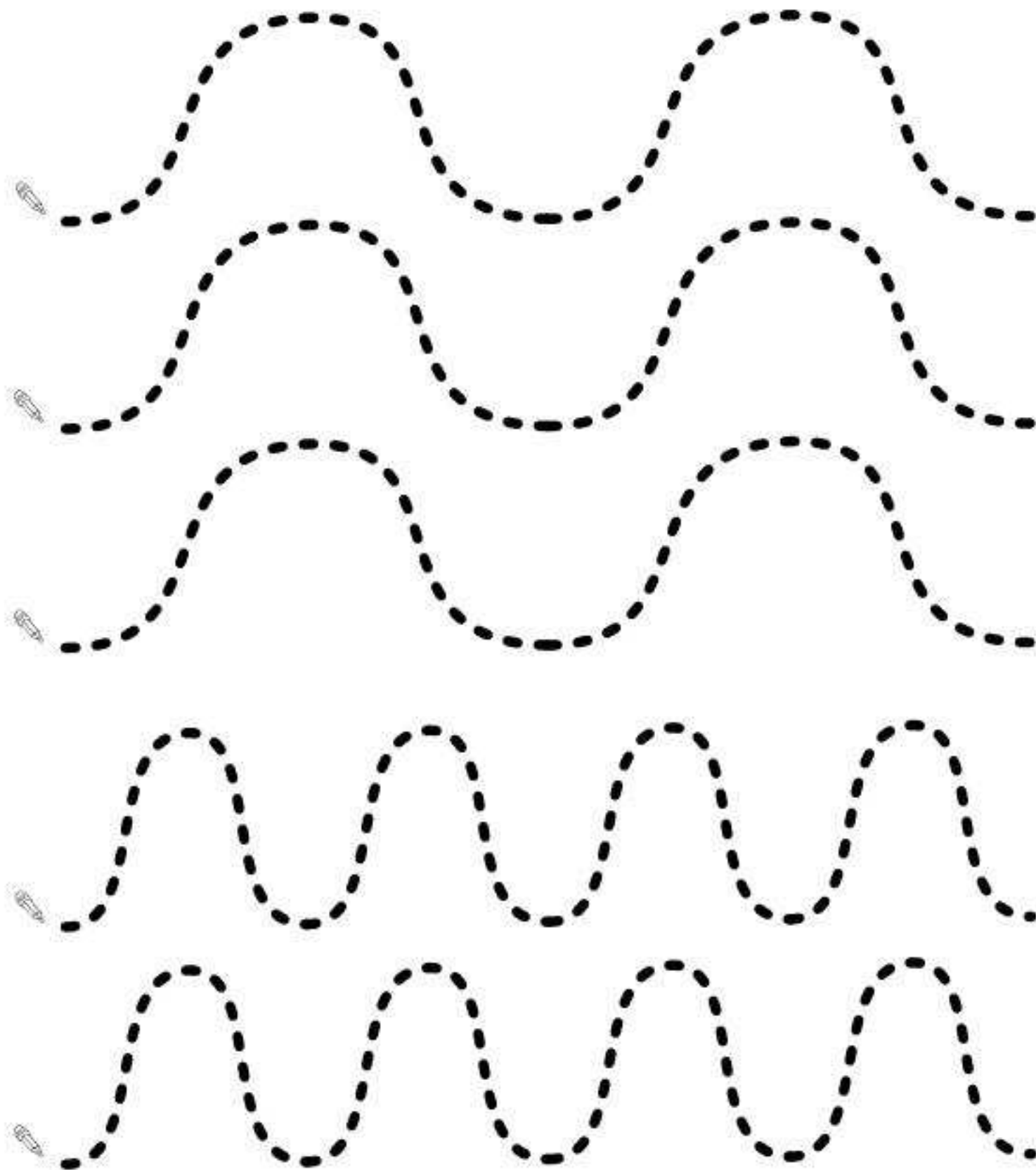

GRAFOMOTRICIDAD

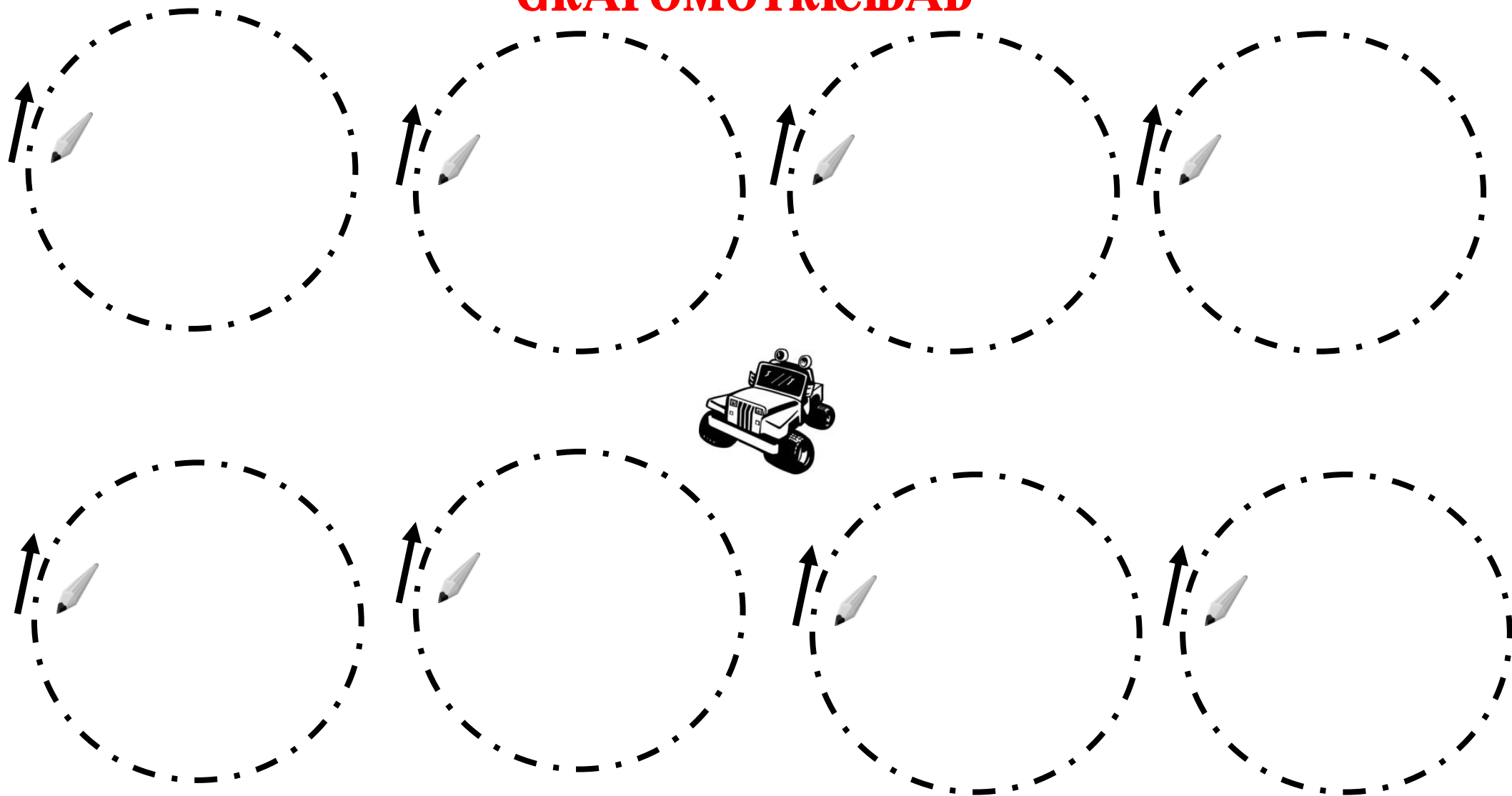

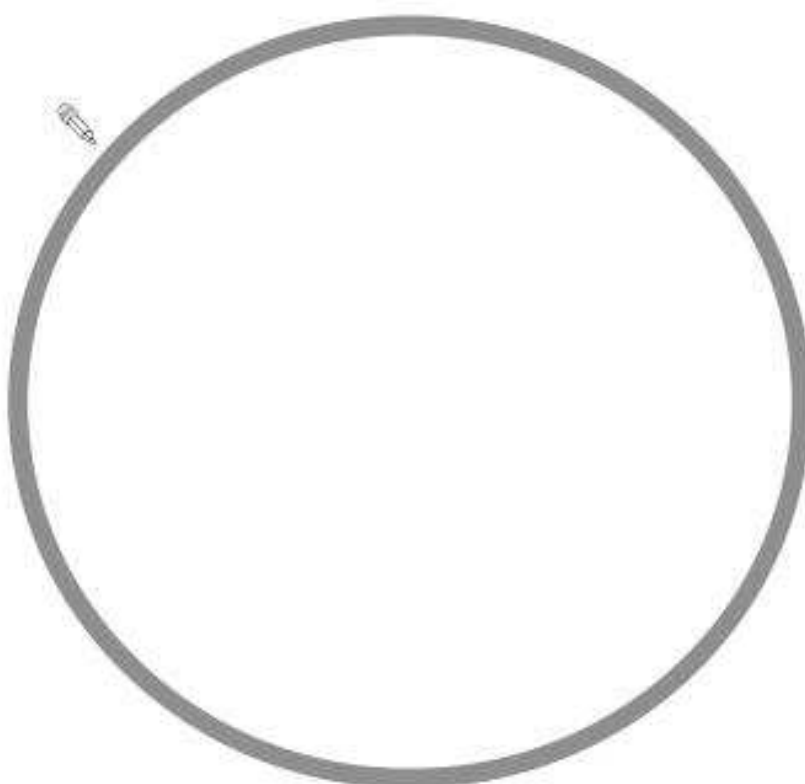
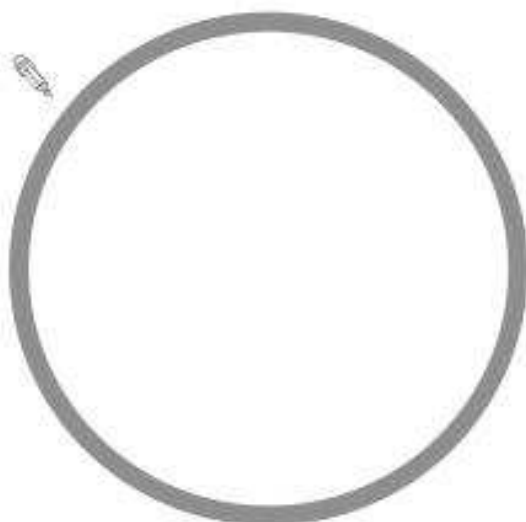

Más material en  <http://orientacionandujar.wordpress.com/>

GRAFOMOTRICIDAD



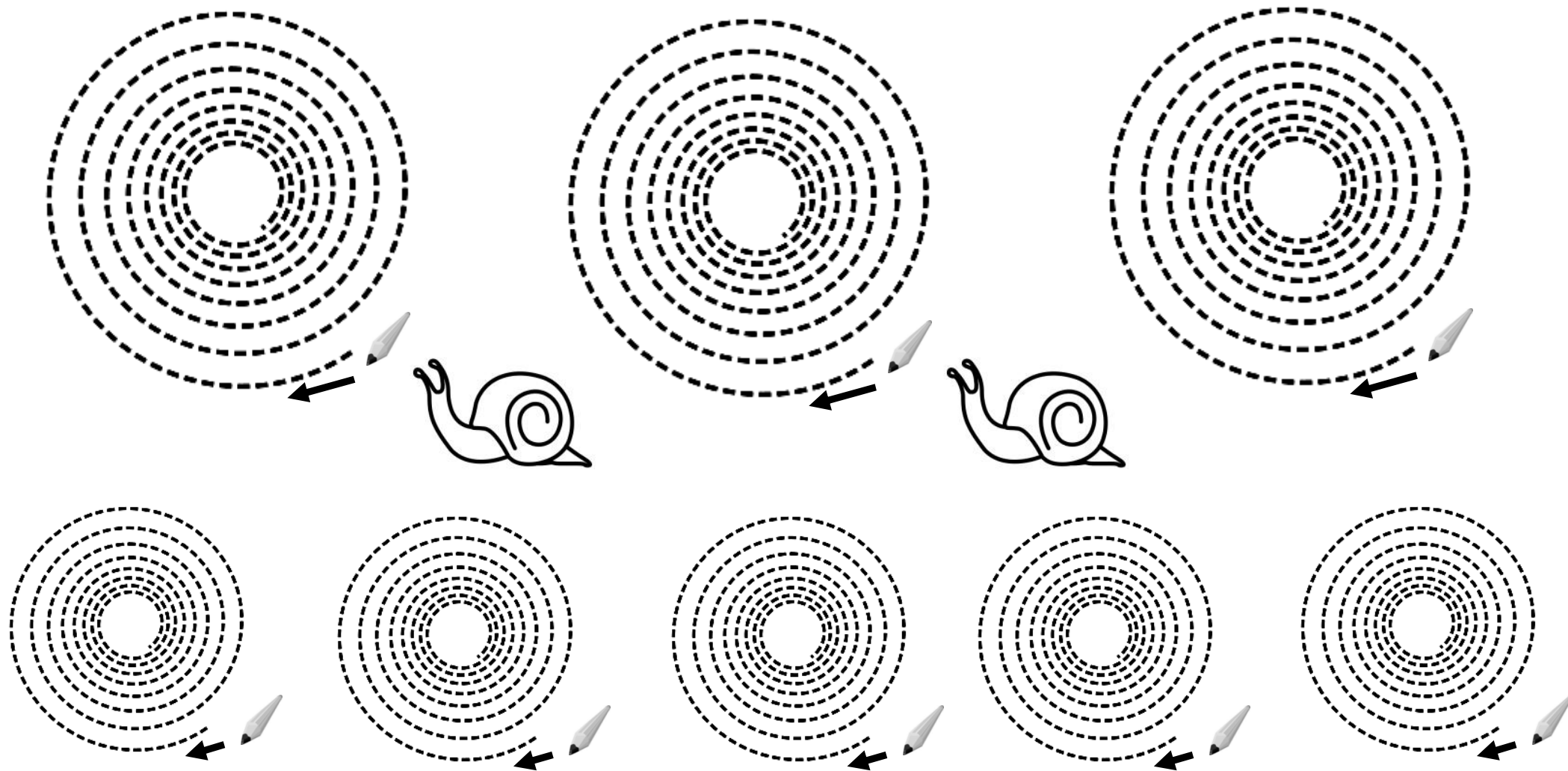

GRAFOMOTRICIDAD

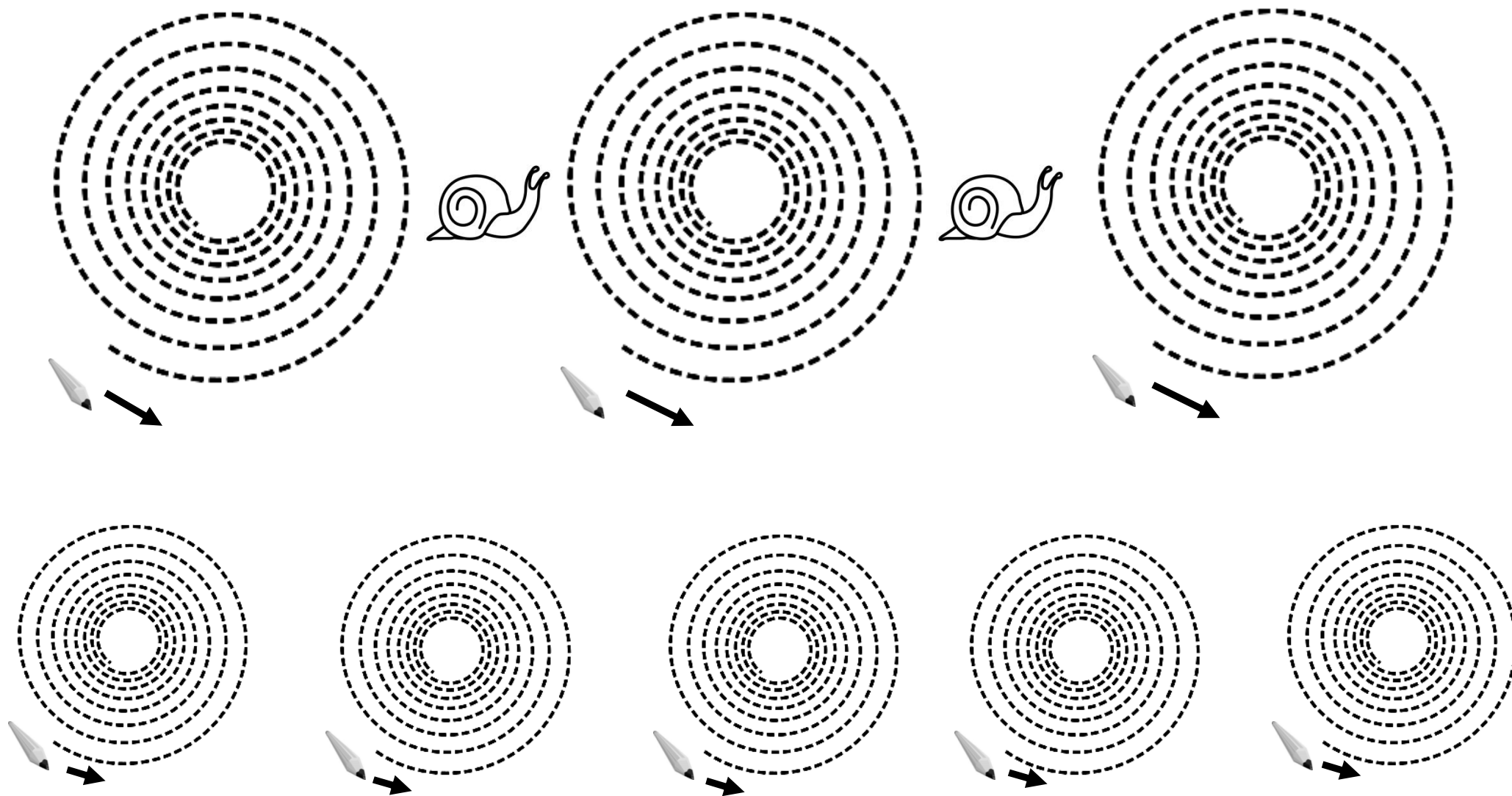

Más material en  <http://orientacionandujar.wordpress.com/>

GRAFOMOTRICIDAD



Más material en  <http://orientacionandujar.wordpress.com/>

GRAFOMOTRICIDAD

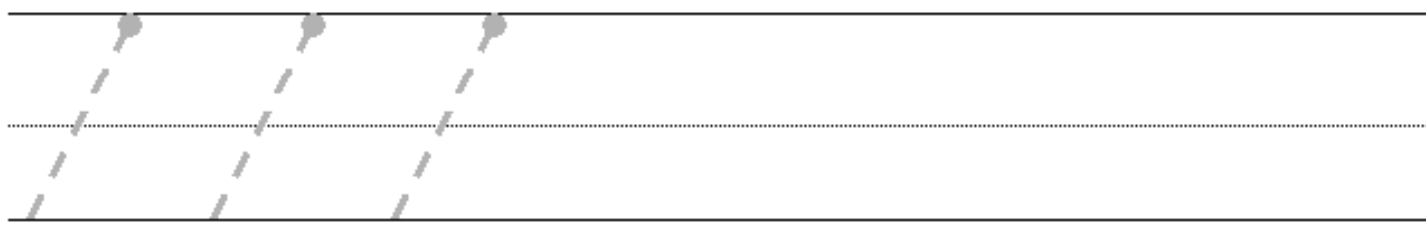
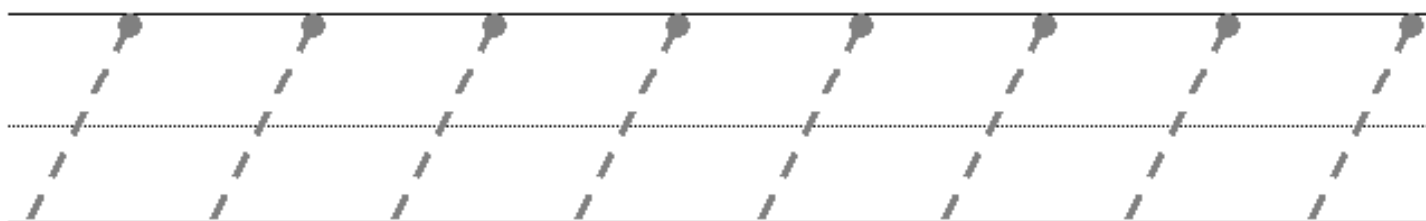
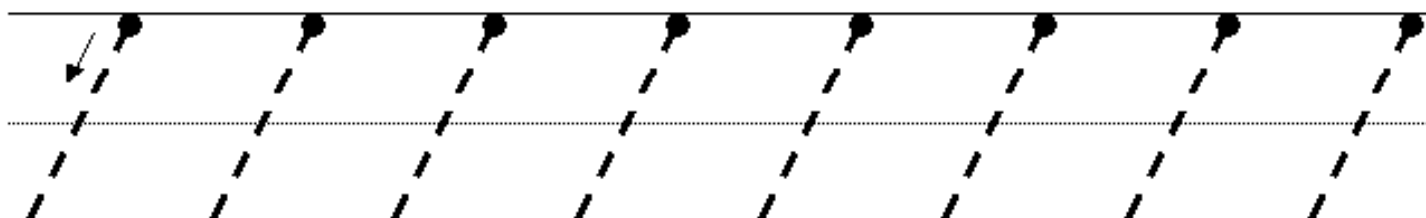
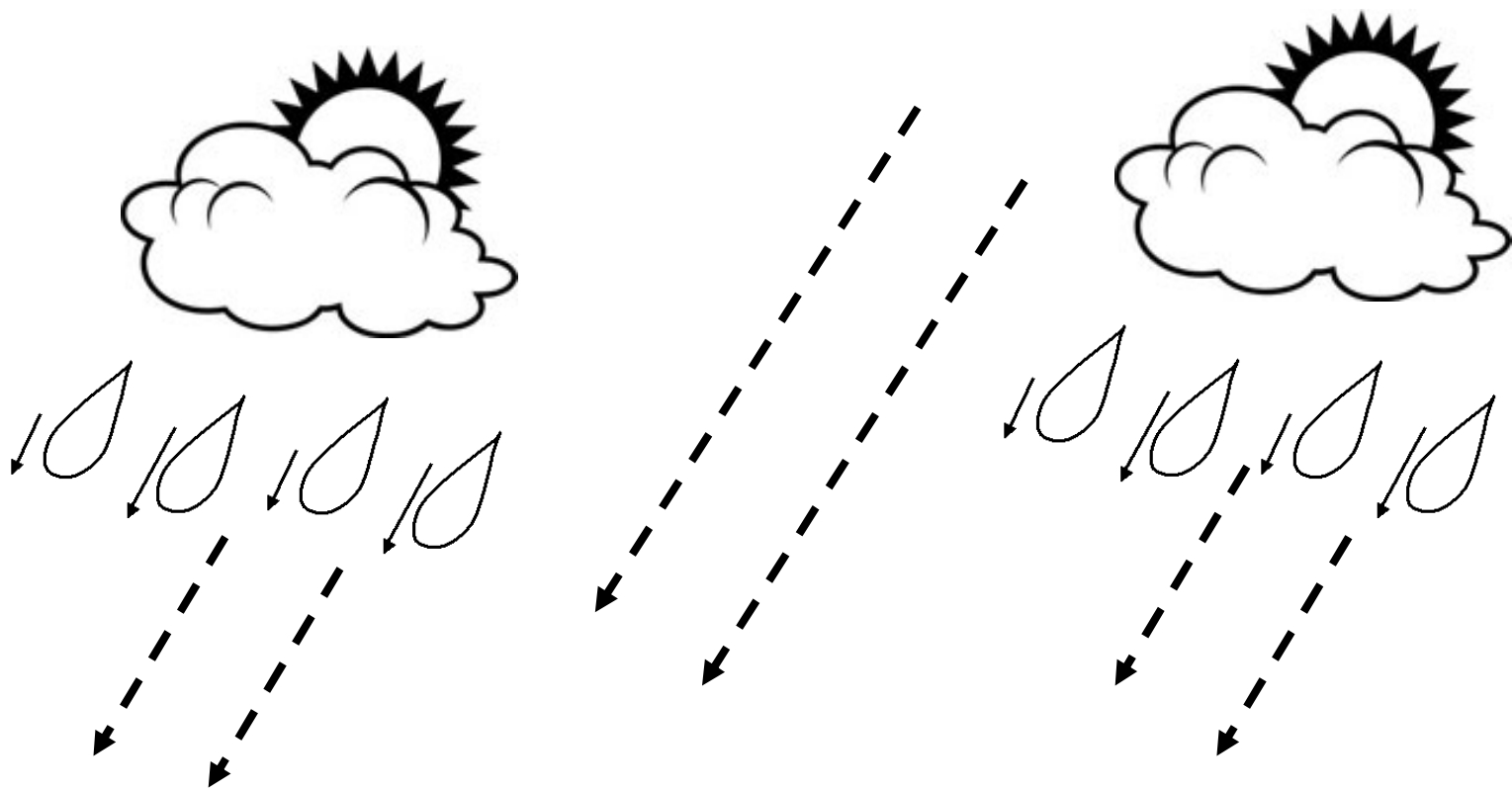

GRAFOMOTRICIDAD

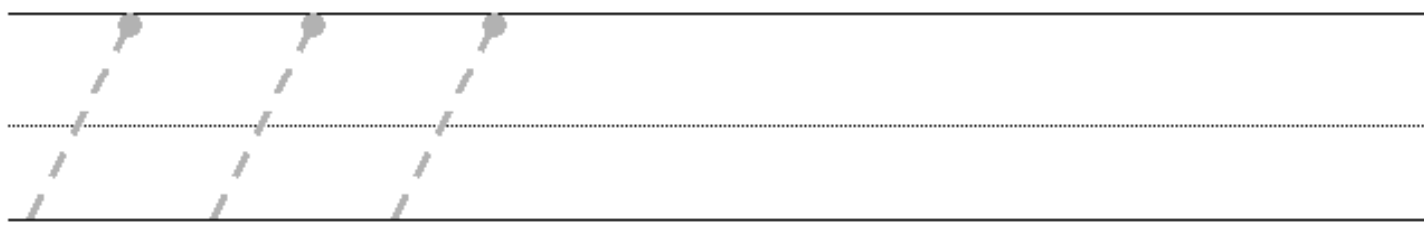
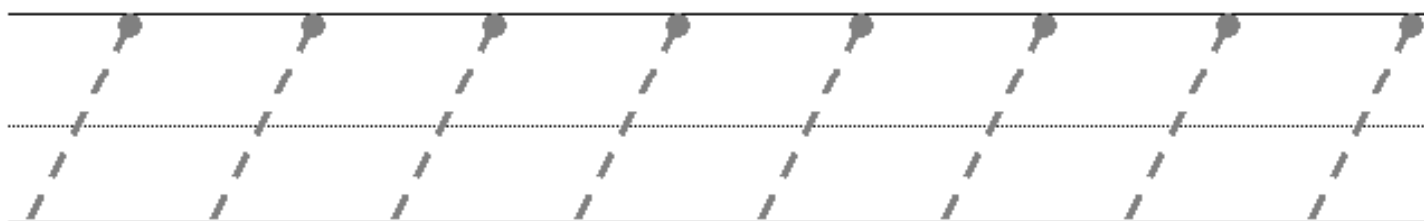
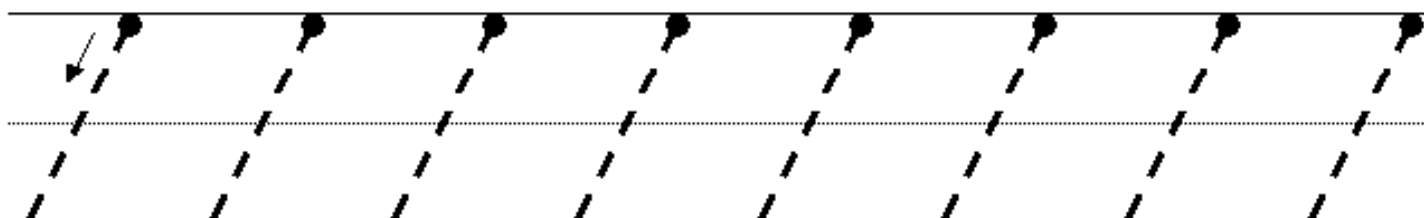
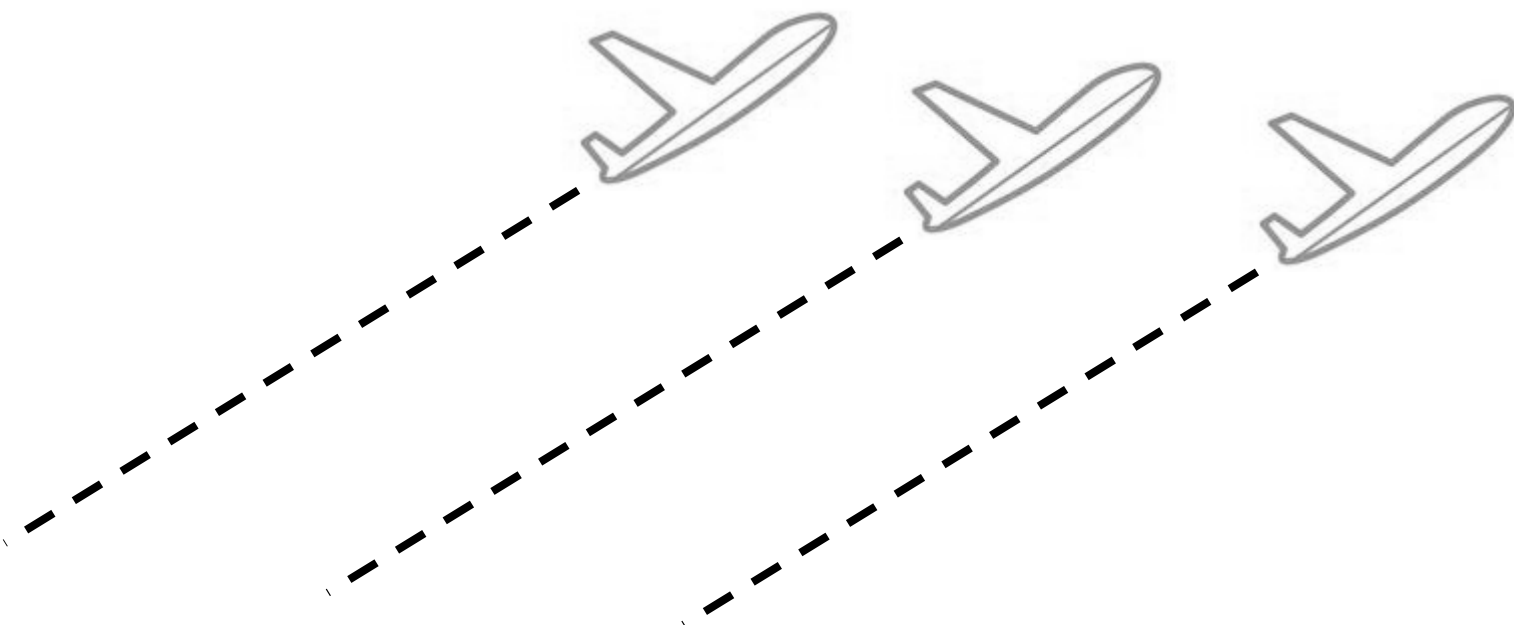

GRAFOMOTRICIDAD

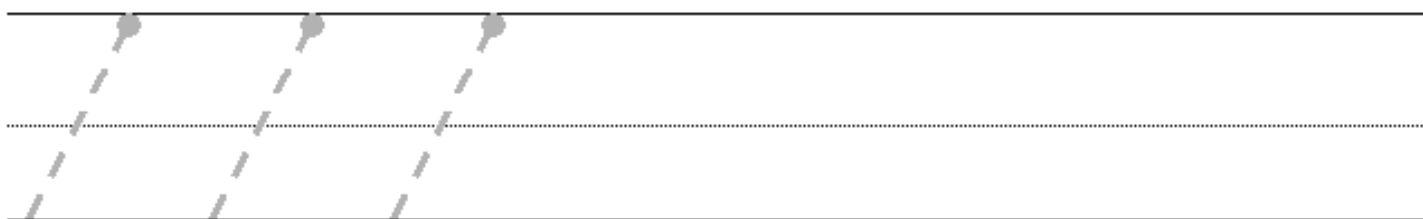
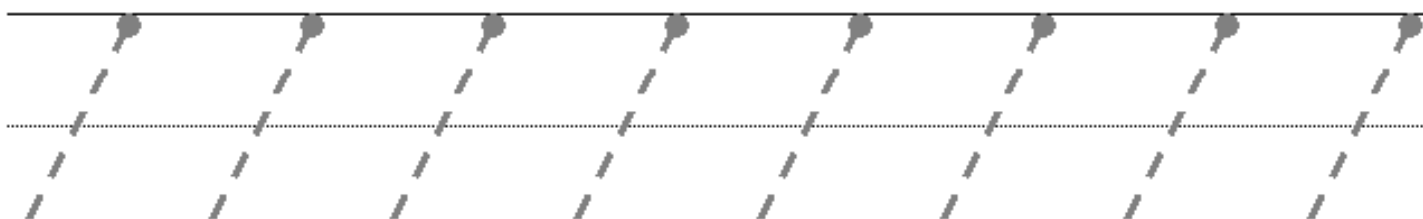
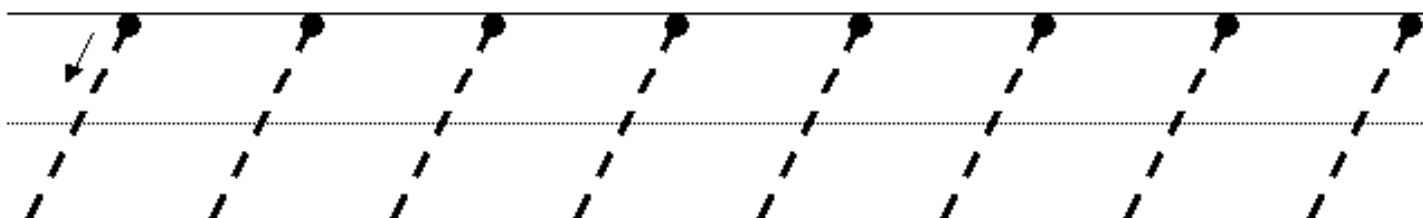
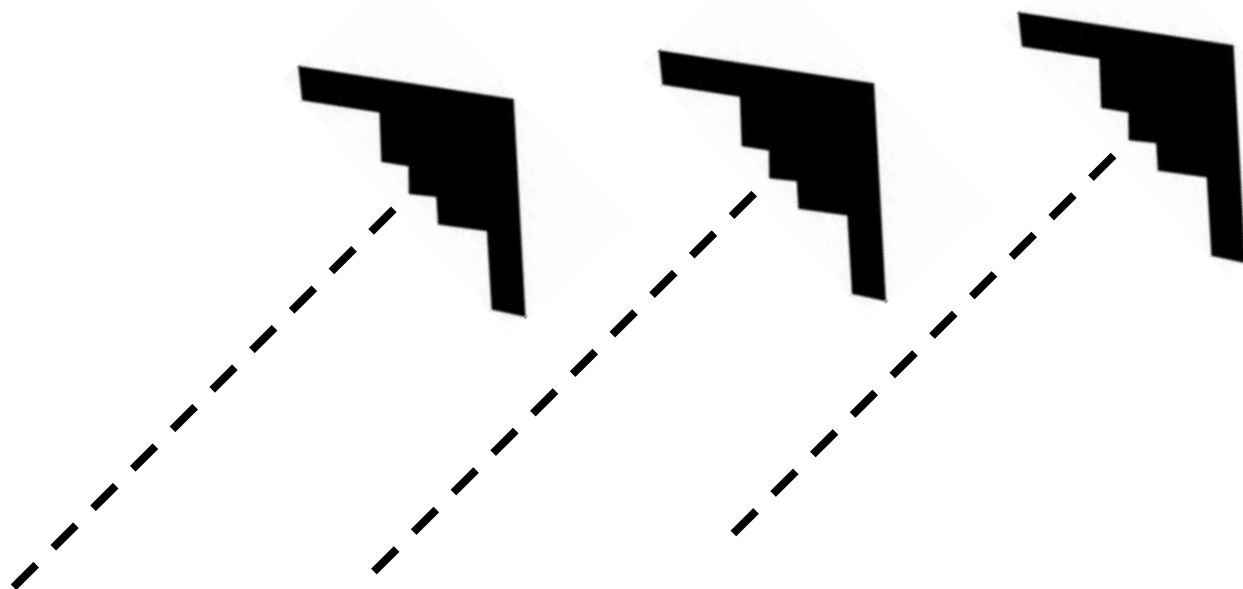

Más material en



<https://orientacionandujar.wordpress.com/>

GRAFOMOTRICIDAD

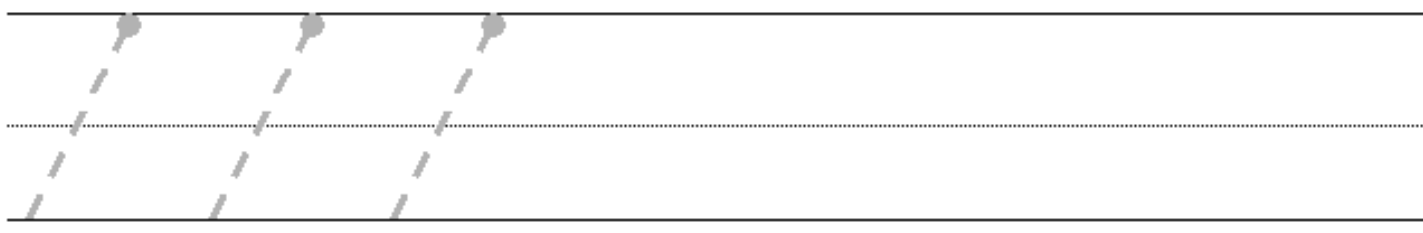
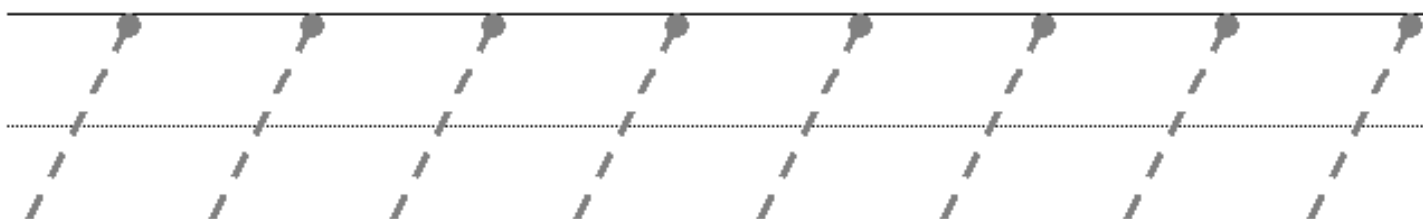
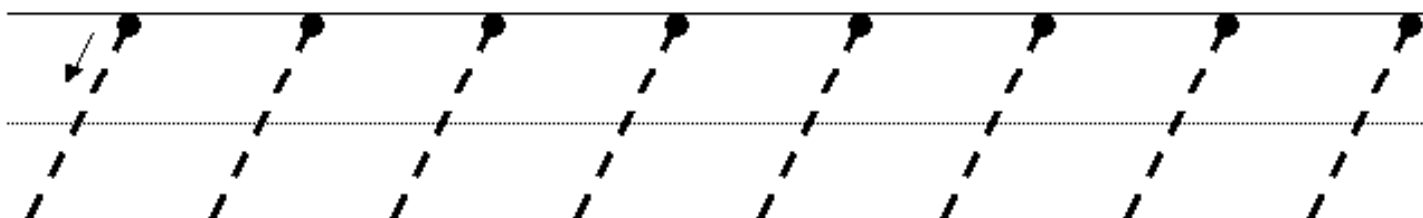
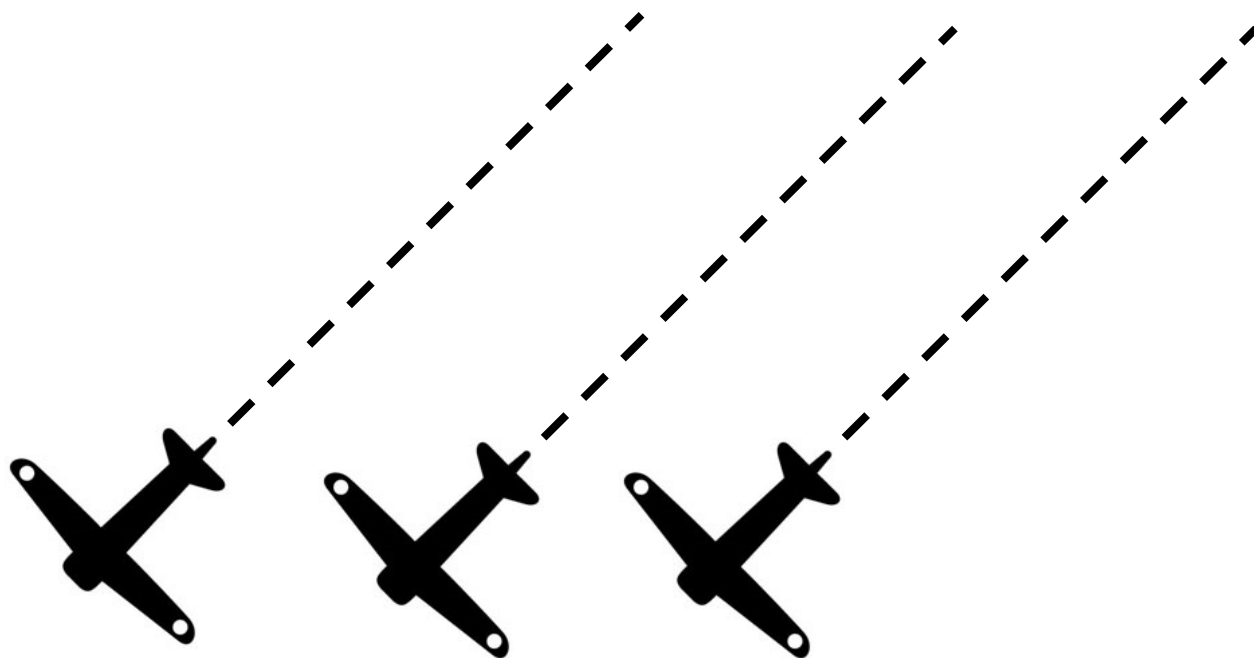

Más material en



<https://orientacionandujar.wordpress.com/>

GRAFOMOTRICIDAD

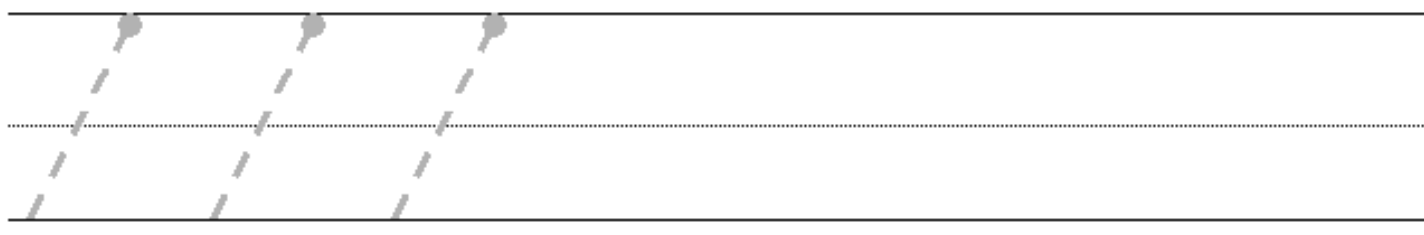
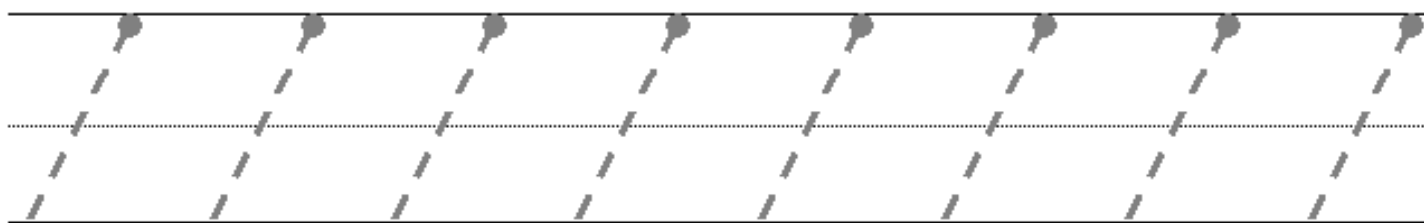
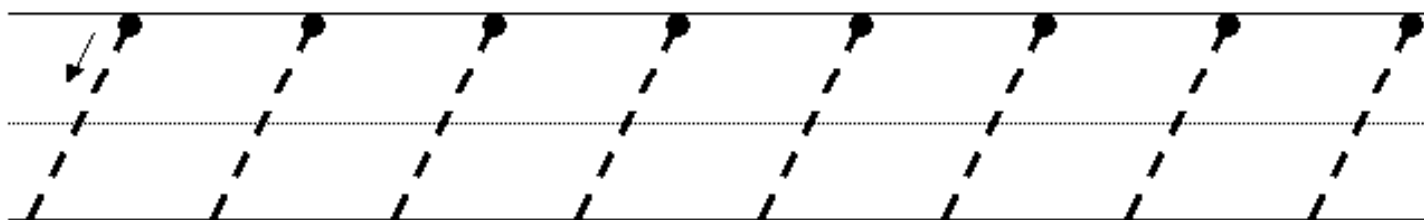
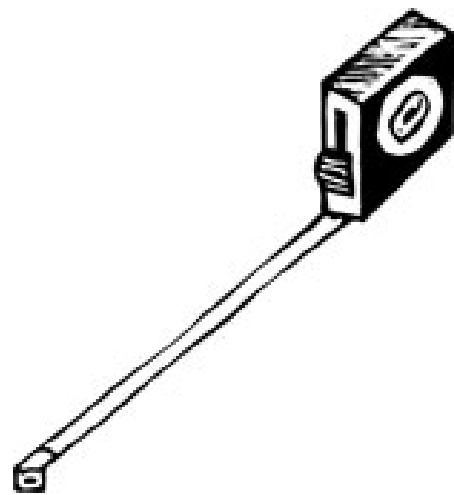
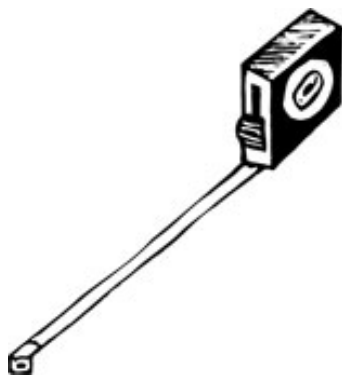
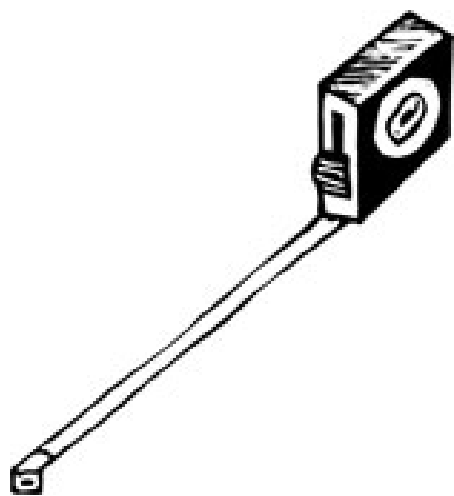

Más material en



<https://orientacionandujar.wordpress.com/>

GRAFOMOTRICIDAD

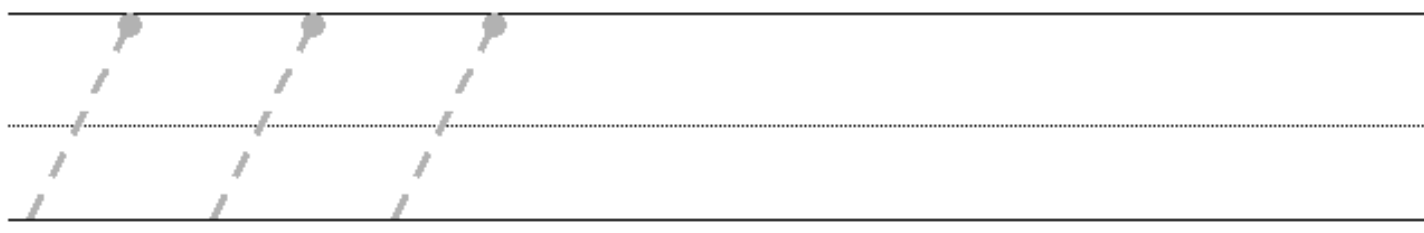
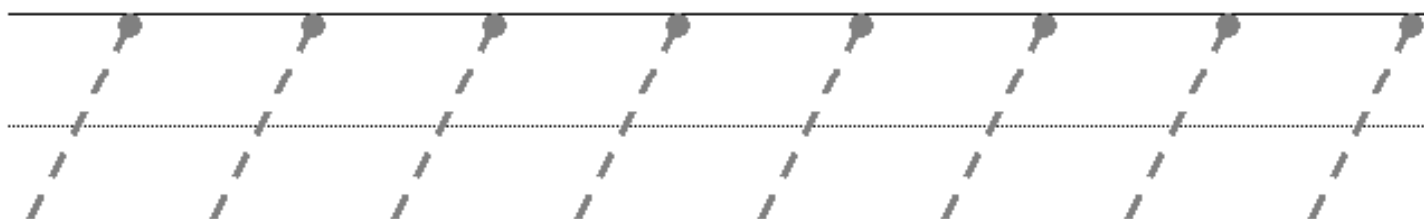
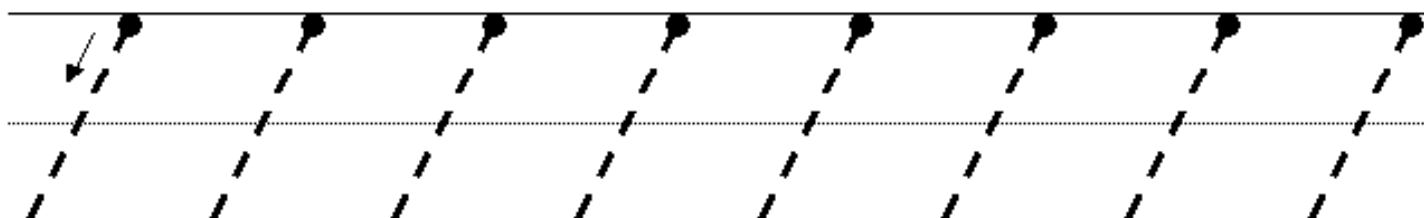

Más material en



<https://orientacionandujar.wordpress.com/>

GRAFOMOTRICIDAD

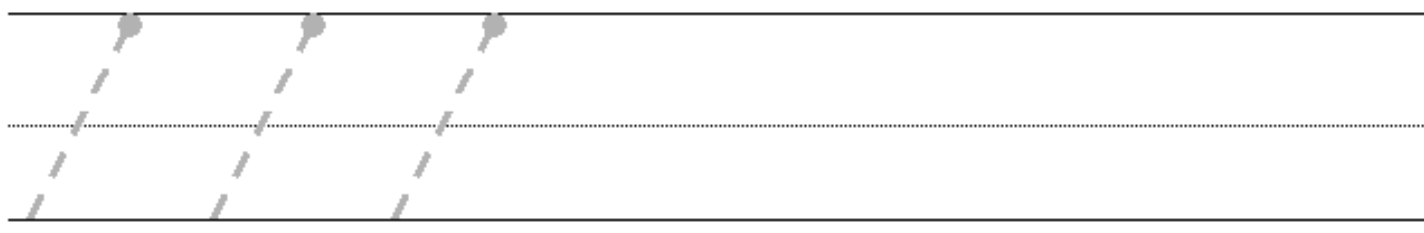
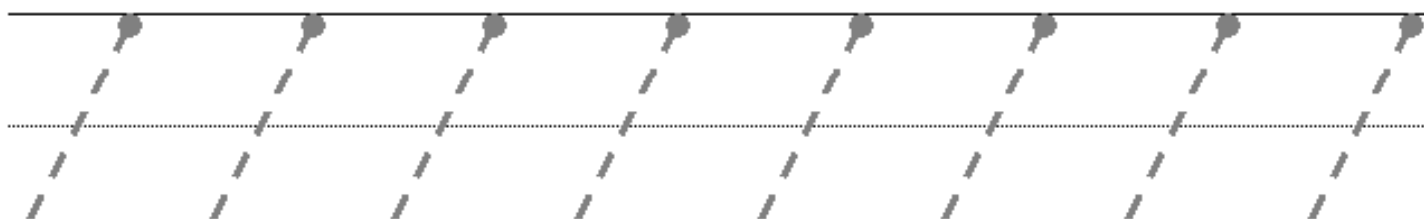
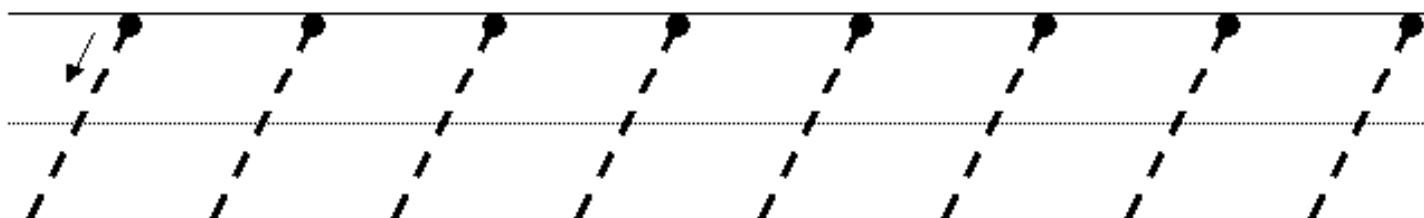

Más material en



<https://orientacionandujar.wordpress.com/>

GRAFOMOTRICIDAD

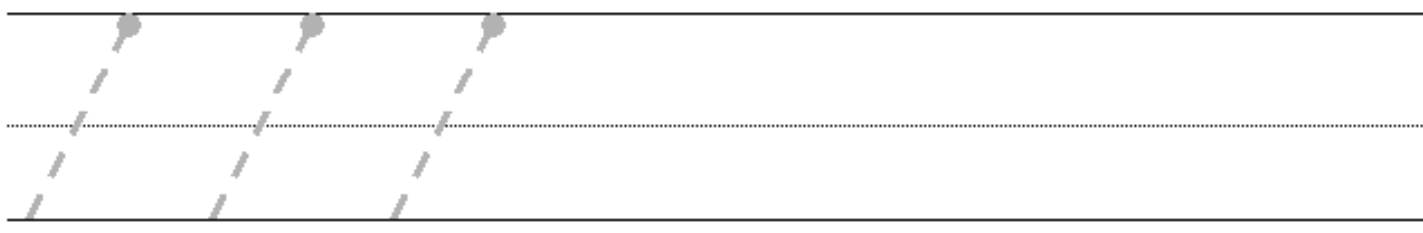
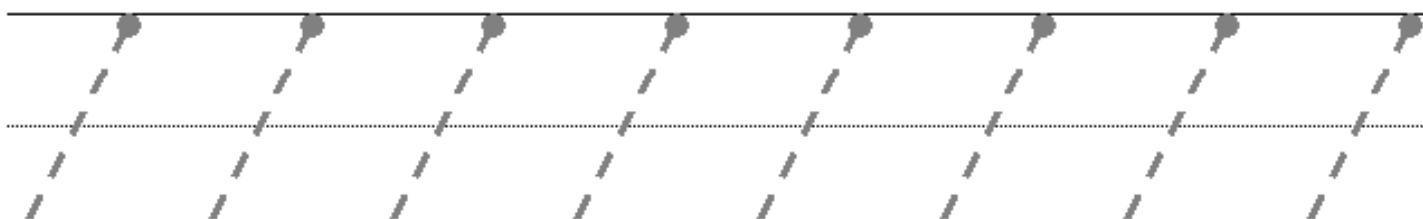
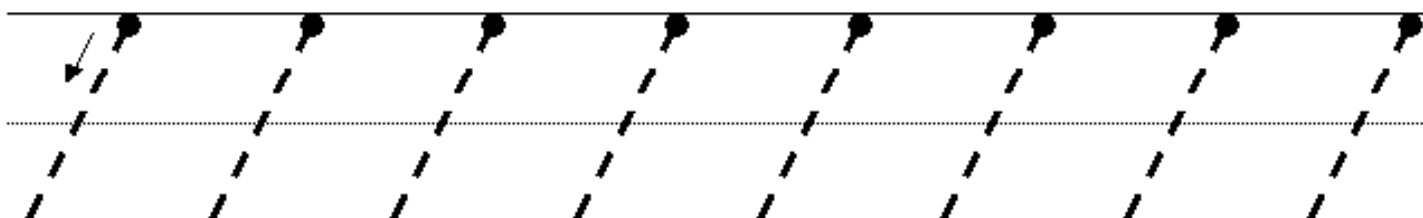
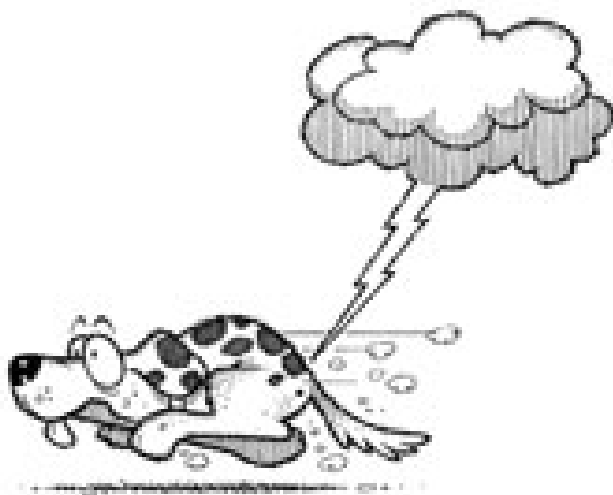

Más material en



<https://orientacionandujar.wordpress.com/>

GRAFOMOTRICIDAD

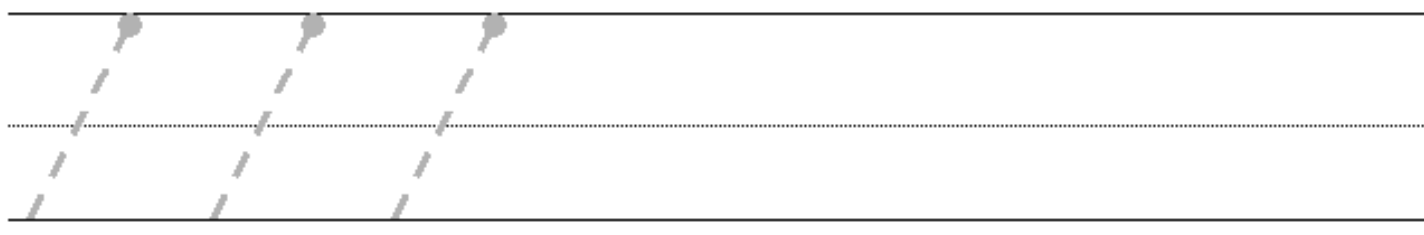
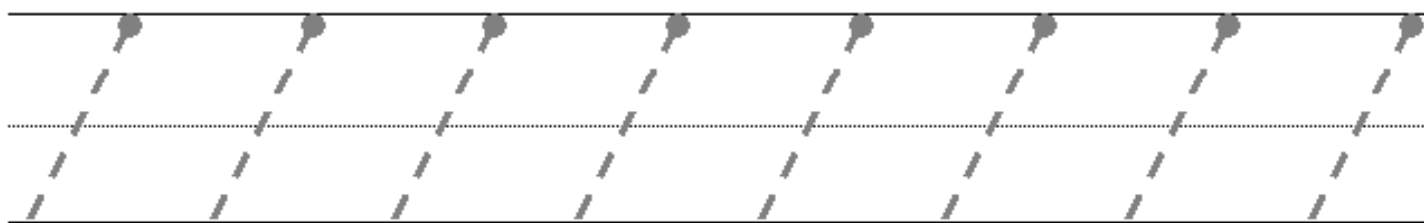
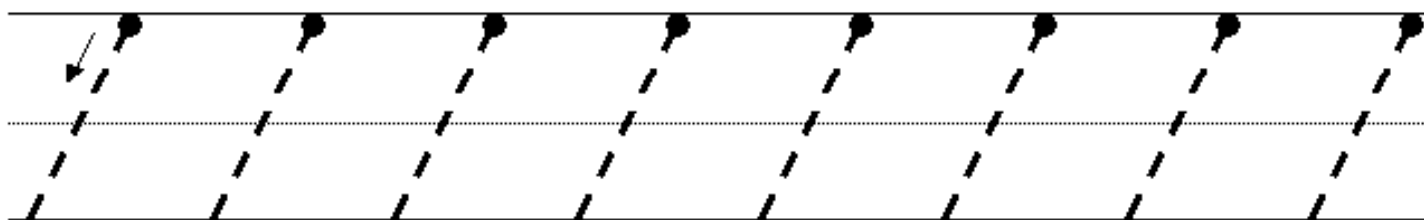
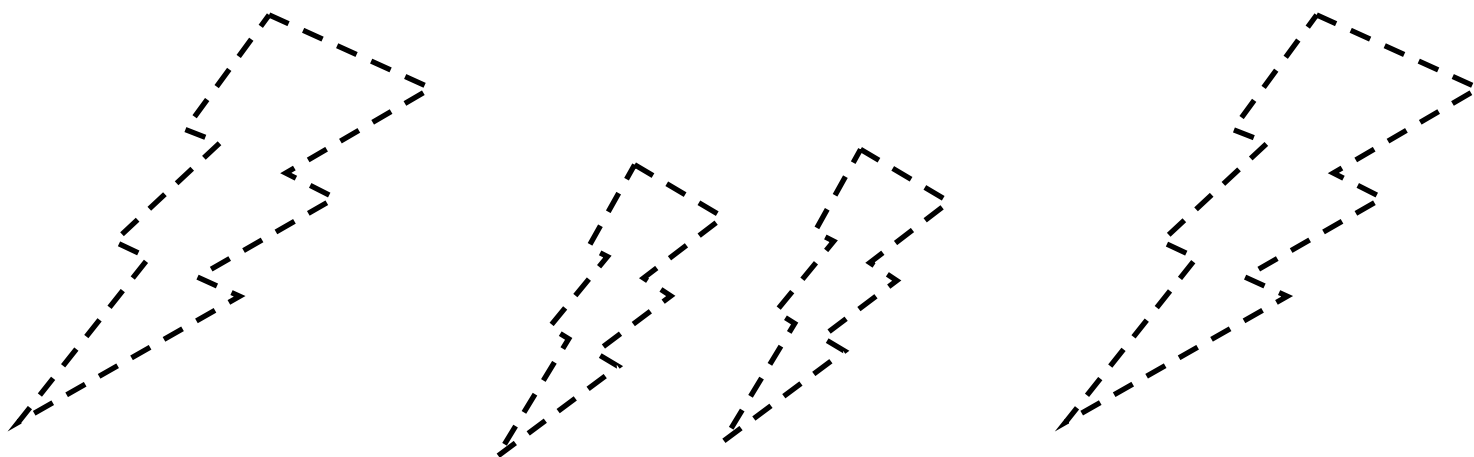

Más material en



<https://orientacionandujar.wordpress.com/>

GRAFOMOTRICIDAD

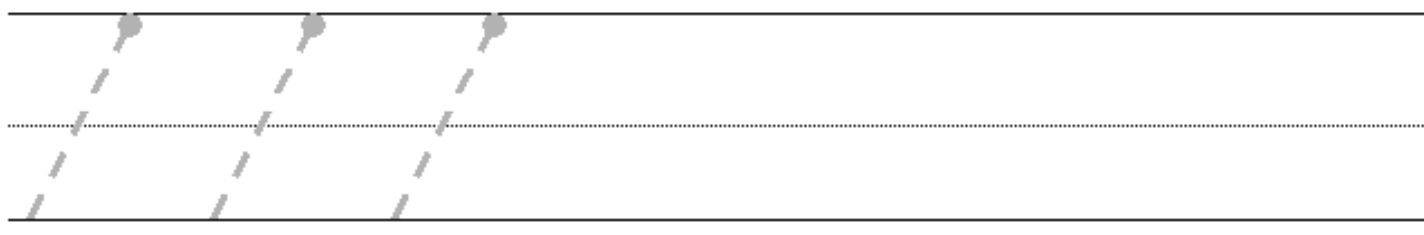
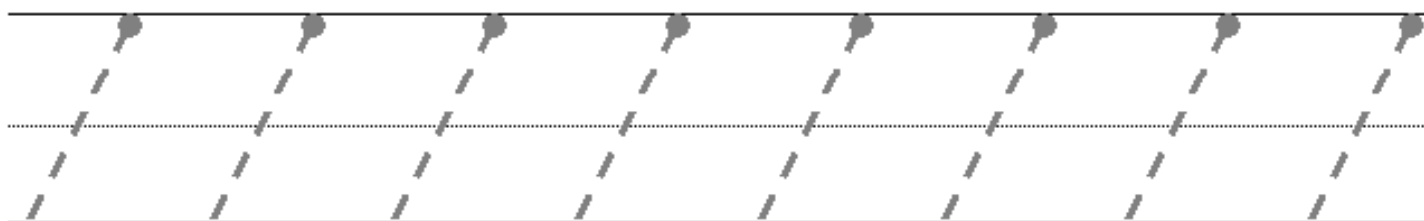
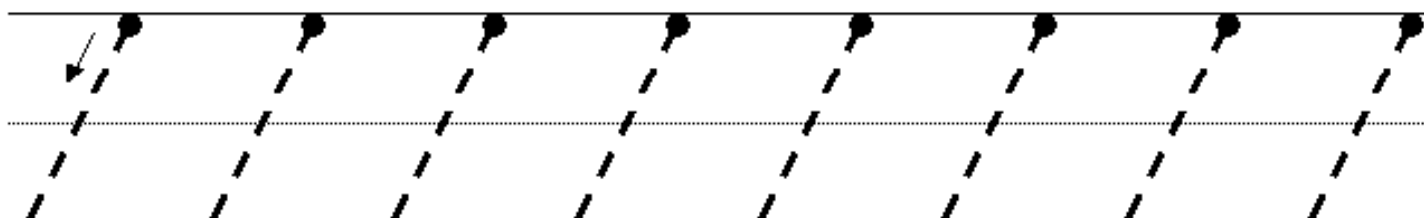

GRAFOMOTRICIDAD

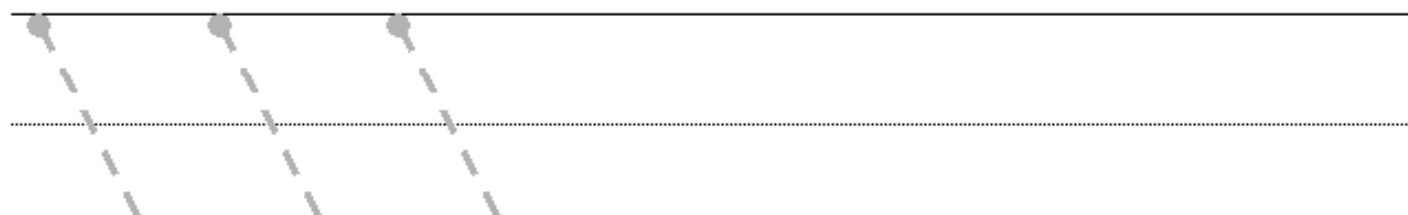
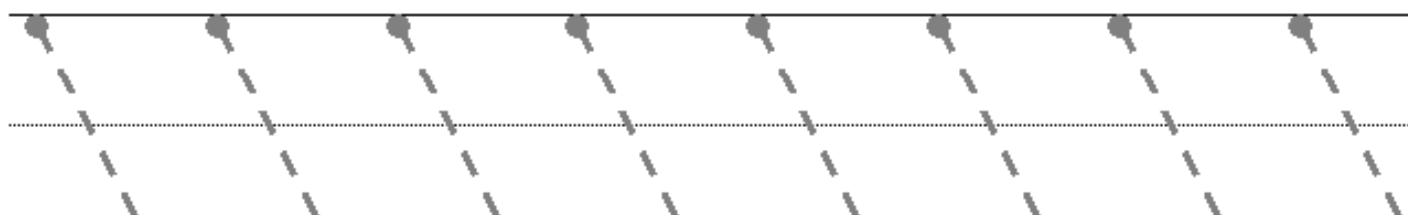
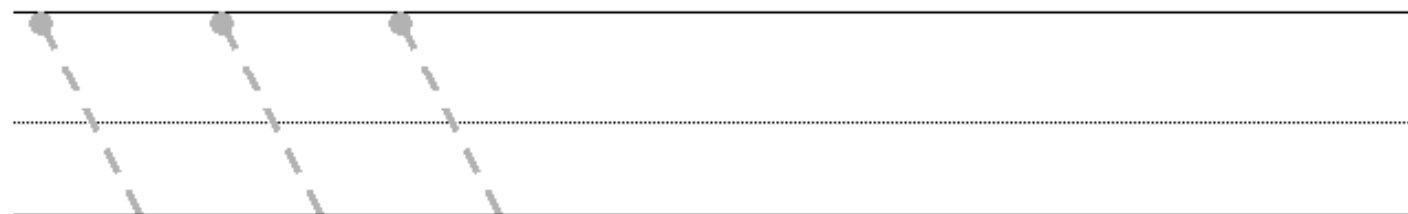
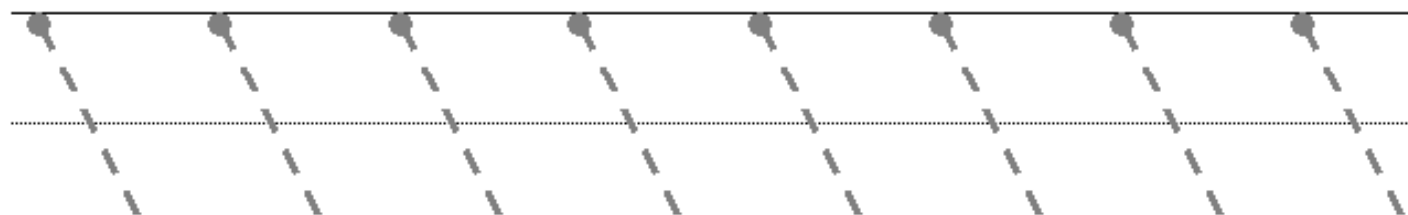
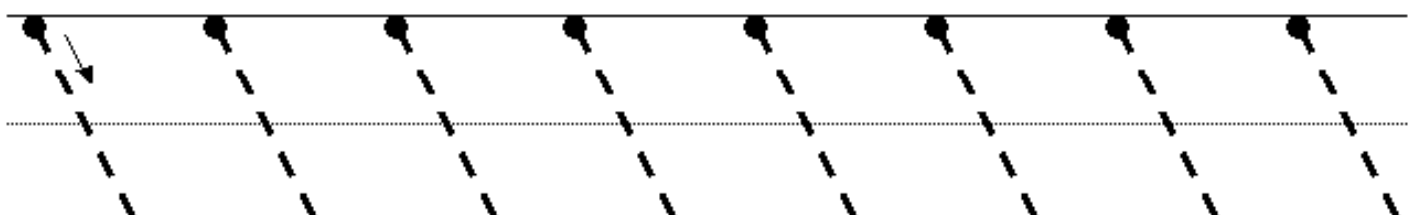
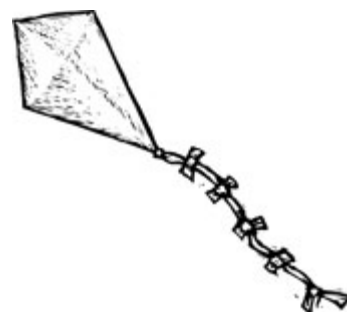
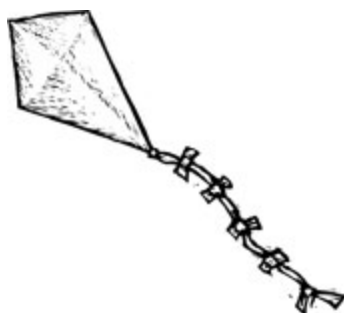
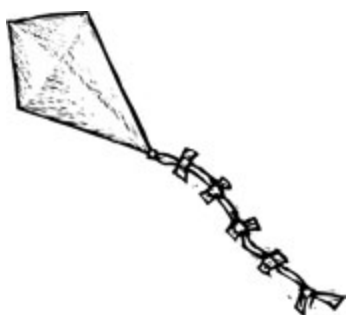

GRAFOMOTRICIDAD

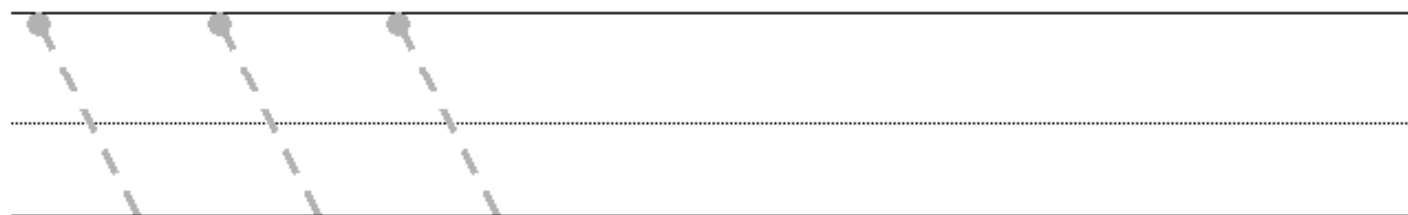
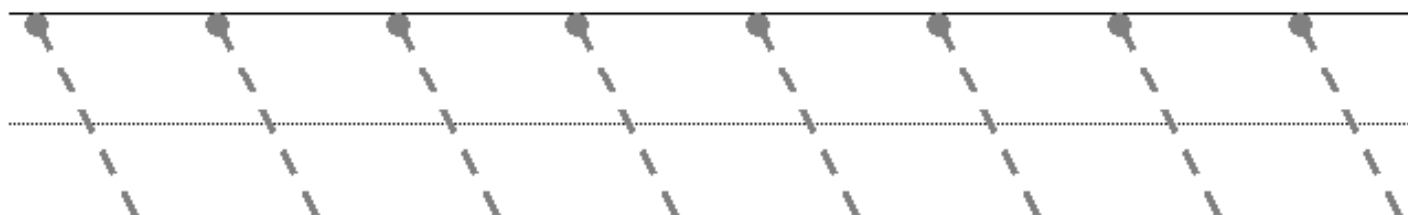
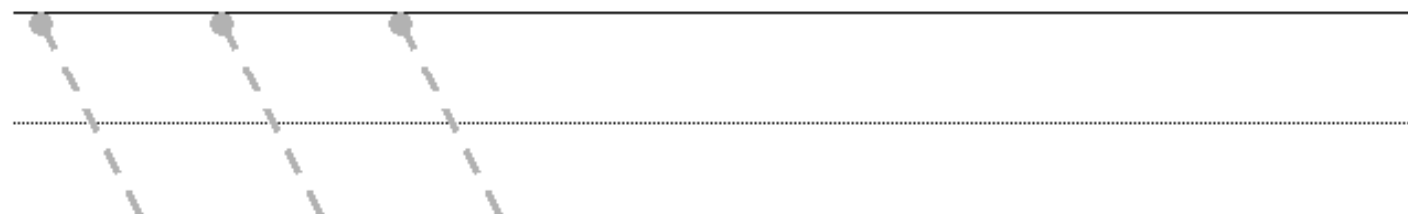
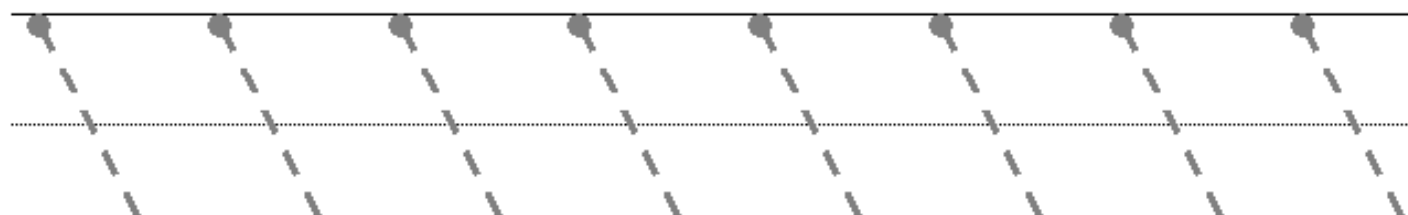
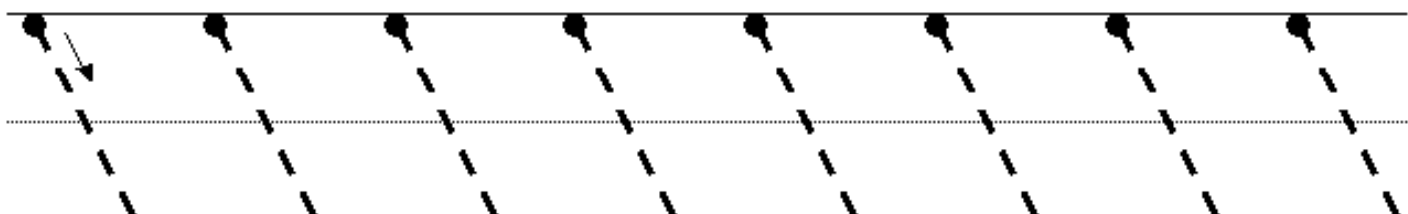
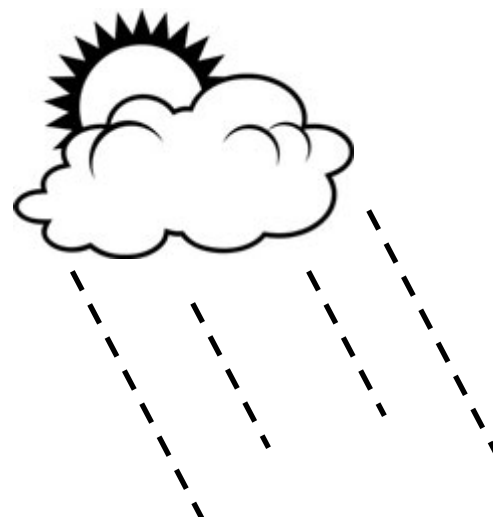
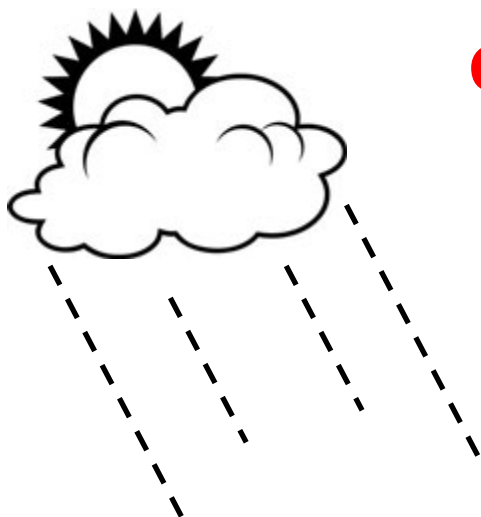

GRAFOMOTRICIDAD

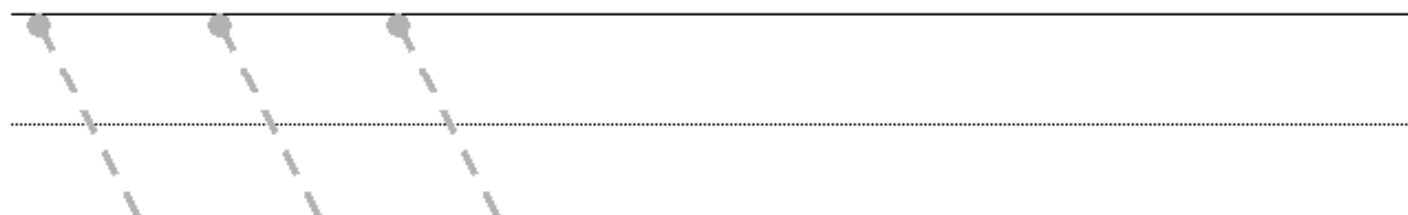
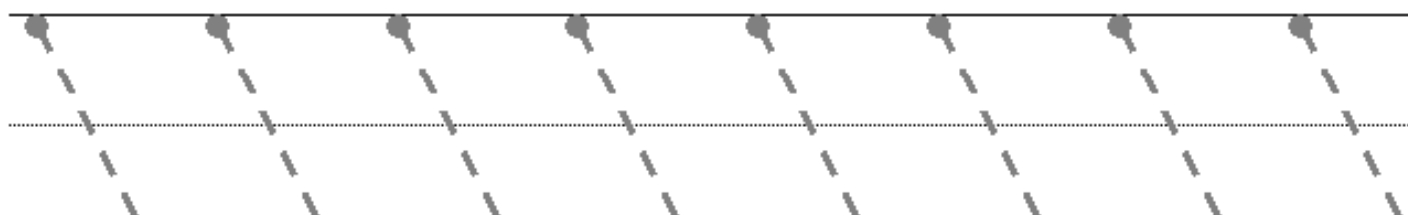
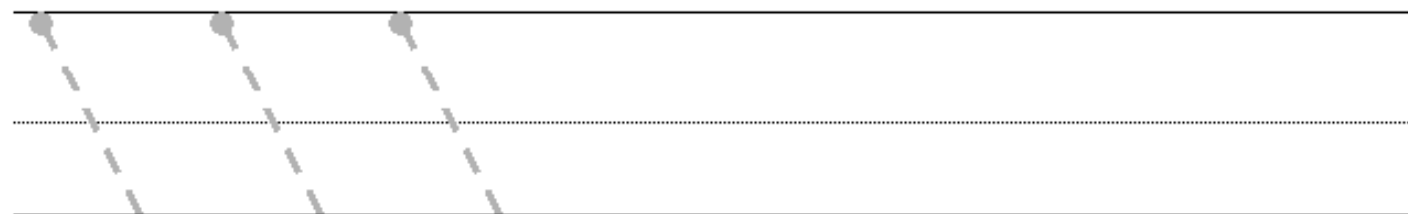
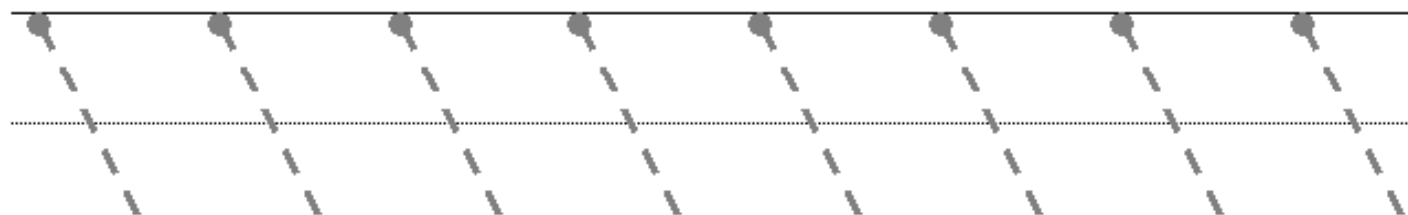
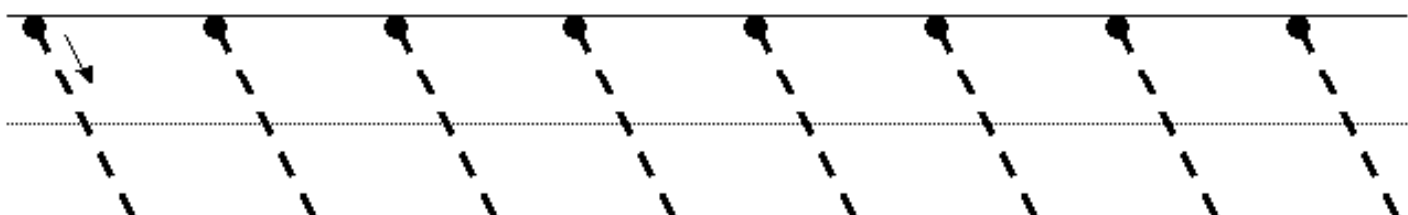
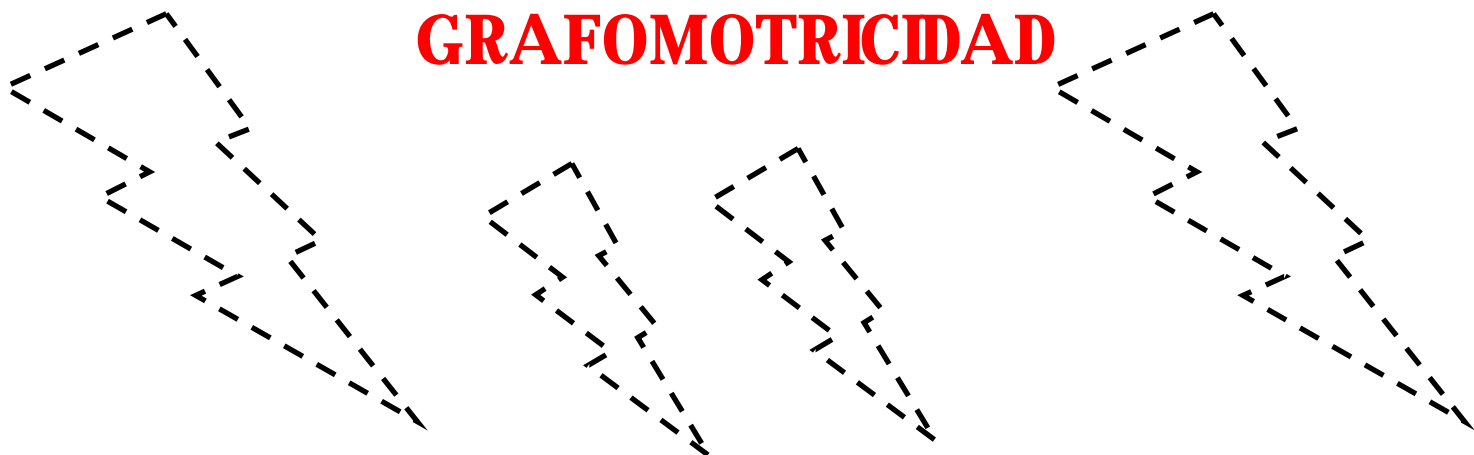

GRAFOMOTRICIDAD

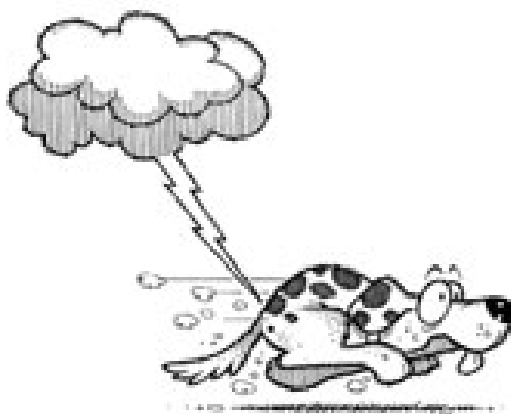

Handwriting practice section consisting of five rows of three-line guides (top solid line, middle dotted line, bottom solid line). Each row contains dashed lines for tracing, starting from a solid black dot on the top line and ending at the bottom line. The first row includes a small arrow pointing downwards from the starting dot to indicate the direction of the stroke. The number of dashed lines per row decreases from eight in the first row to three in the fifth row.

Más material en



<https://orientacionandujar.wordpress.com/>

GRAFOMOTRICIDAD

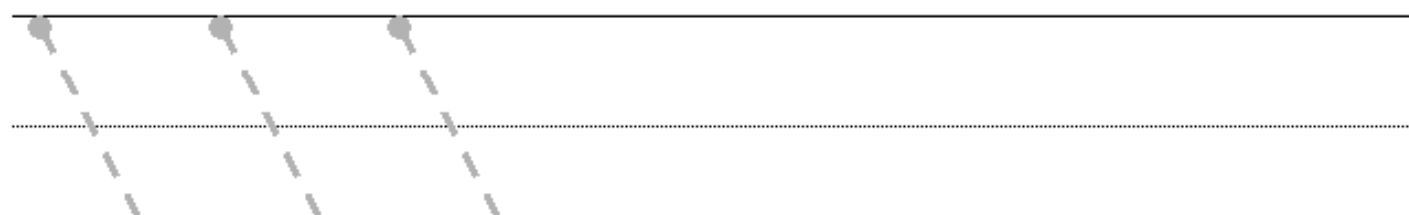
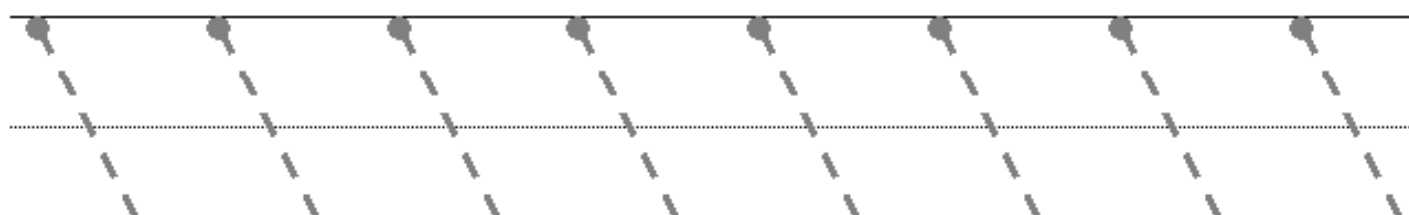
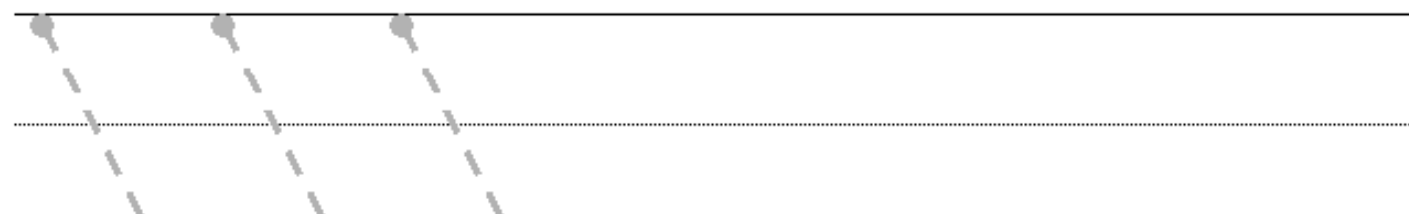
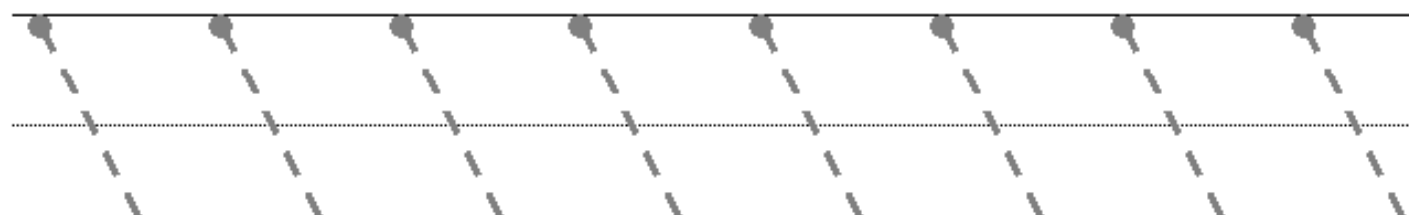
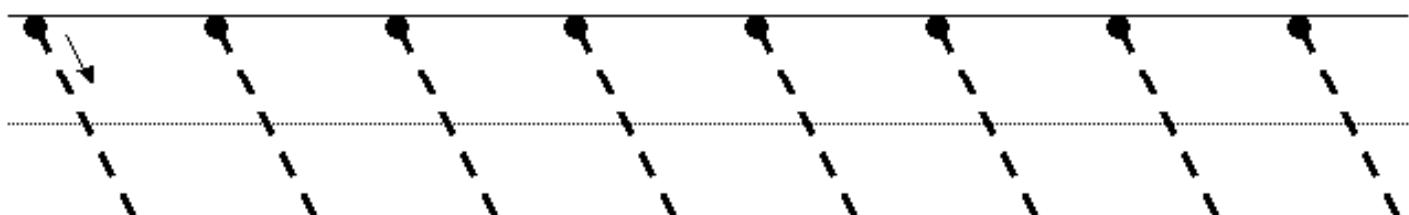

GRAFOMOTRICIDAD

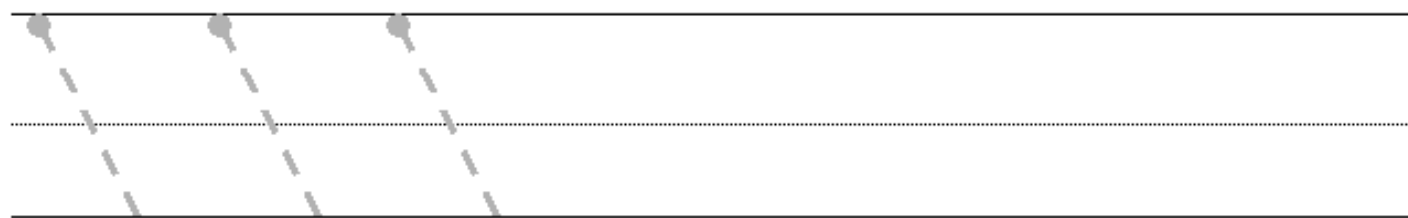
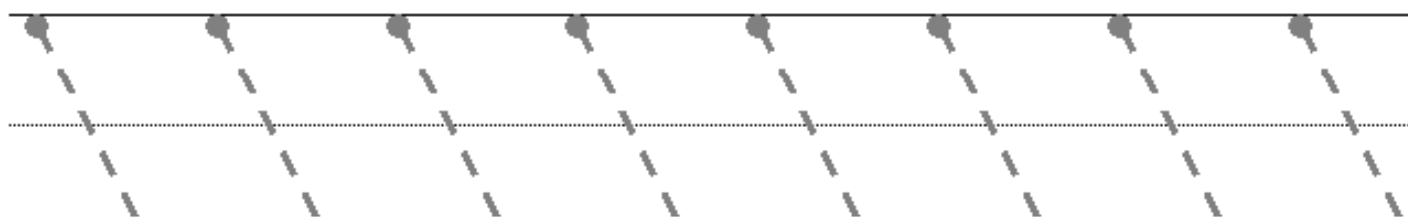
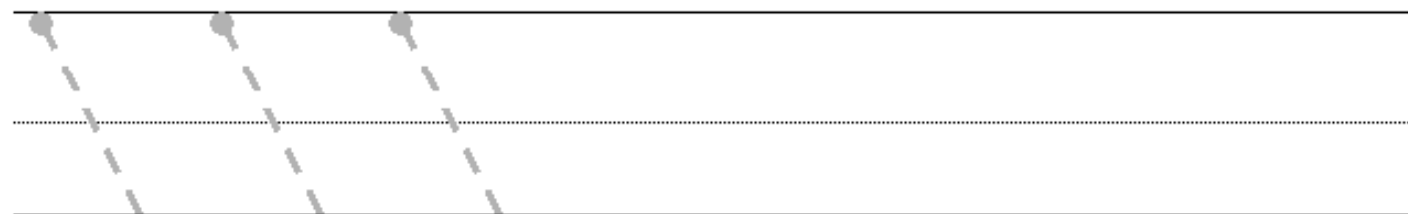
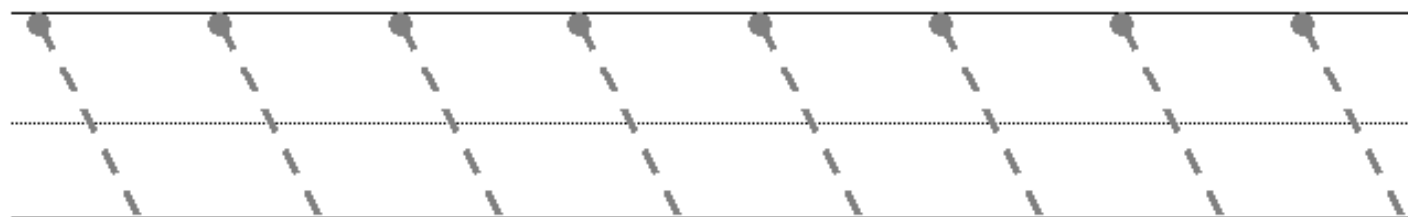
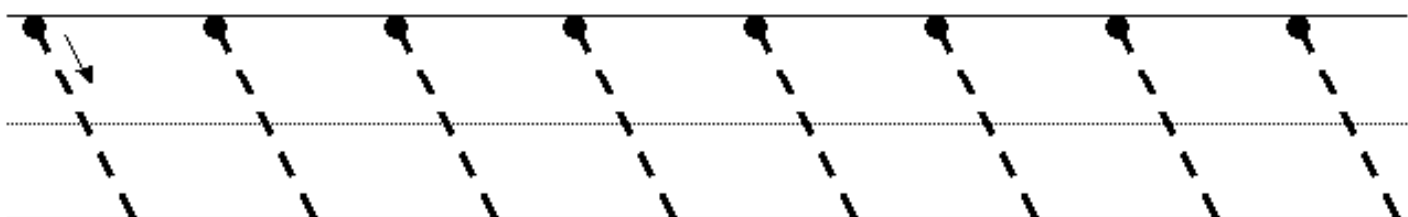

GRAFOMOTRICIDAD

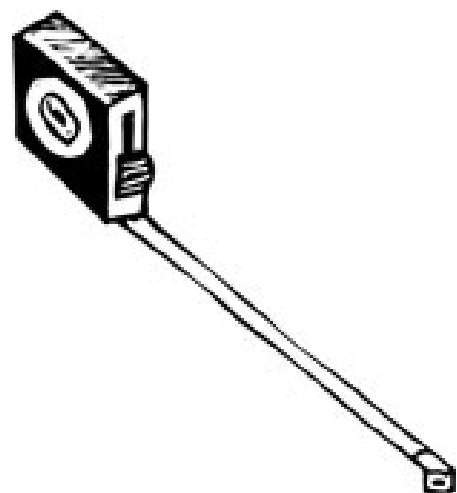
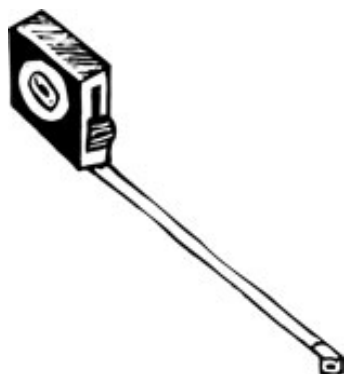
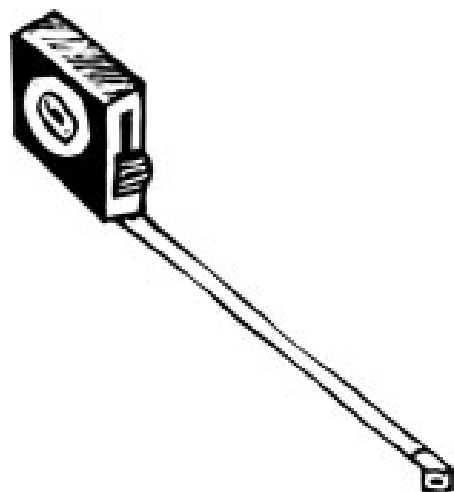

Handwriting practice section consisting of six rows of three-line guides (top solid line, middle dotted line, bottom solid line). Each row contains a series of slanted dashed lines for tracing. The first row has a small arrow pointing downwards at the start of the first dashed line. The number of dashed lines per row is: Row 1: 8; Row 2: 8; Row 3: 3; Row 4: 8; Row 5: 3.



GRAFOMOTRICIDAD

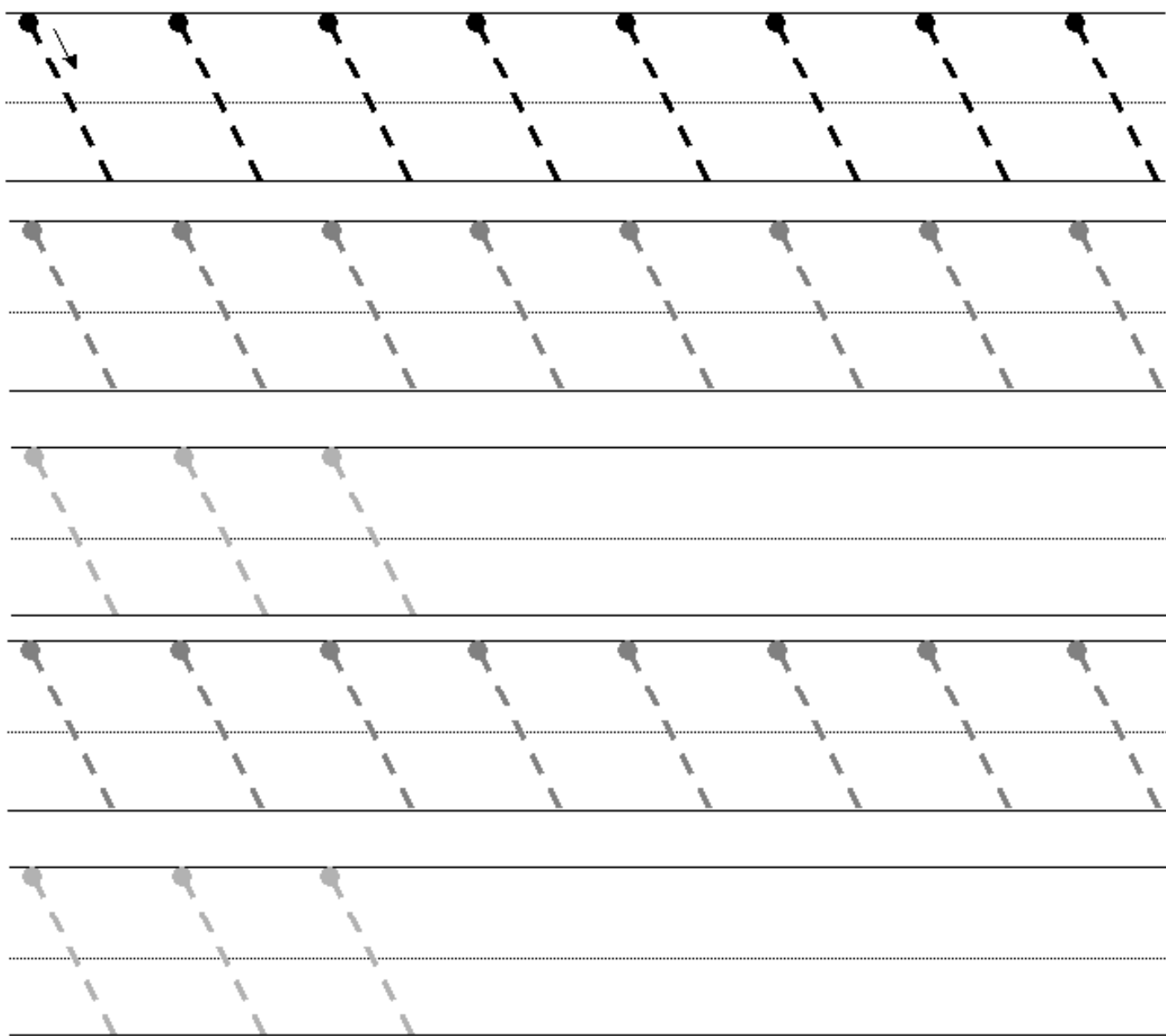



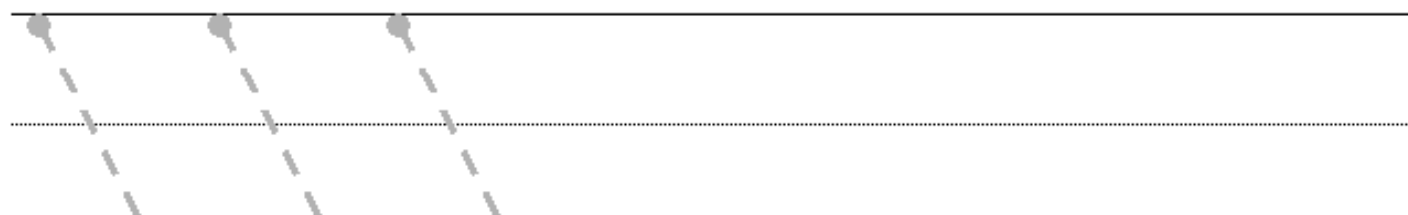
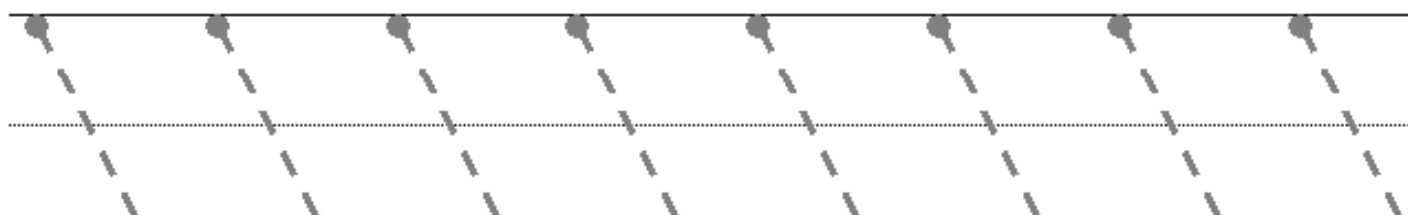
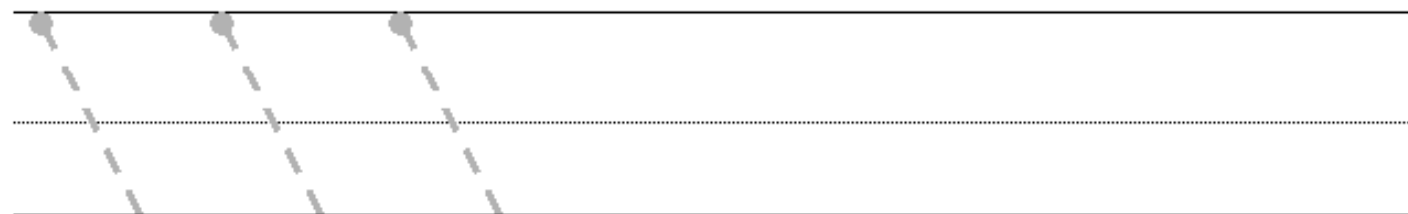
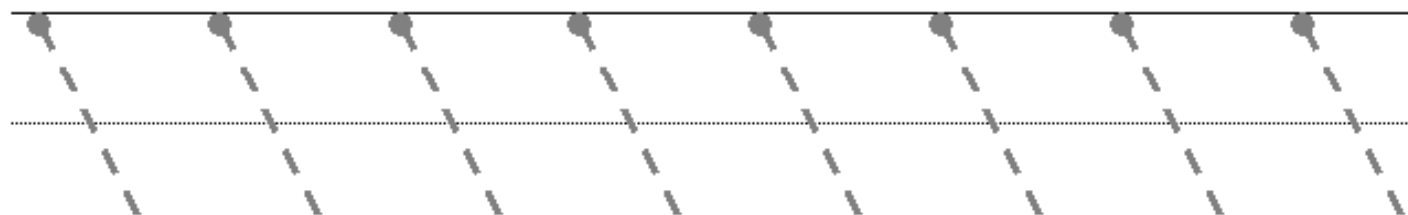
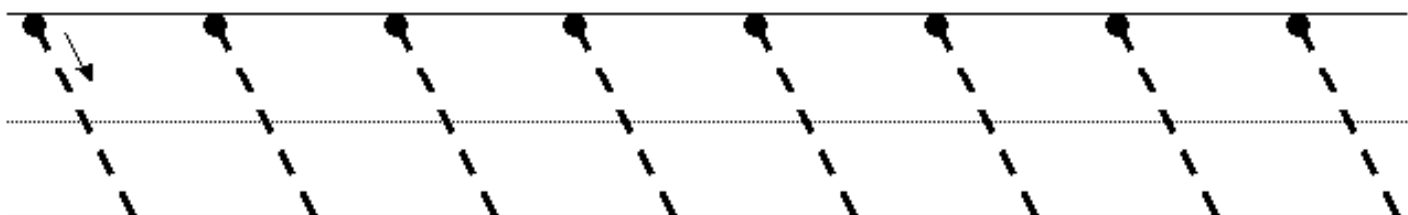



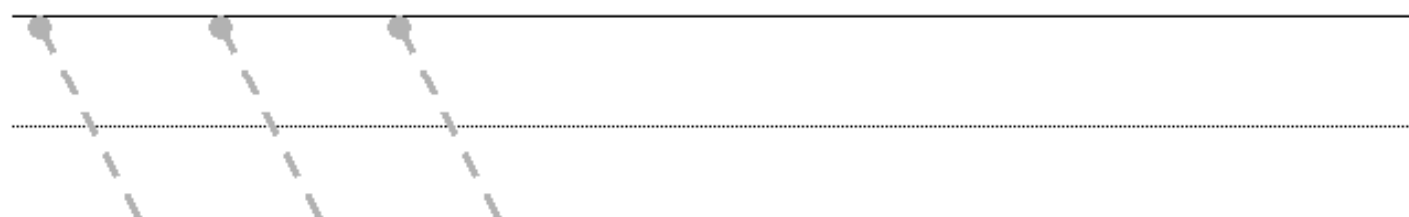
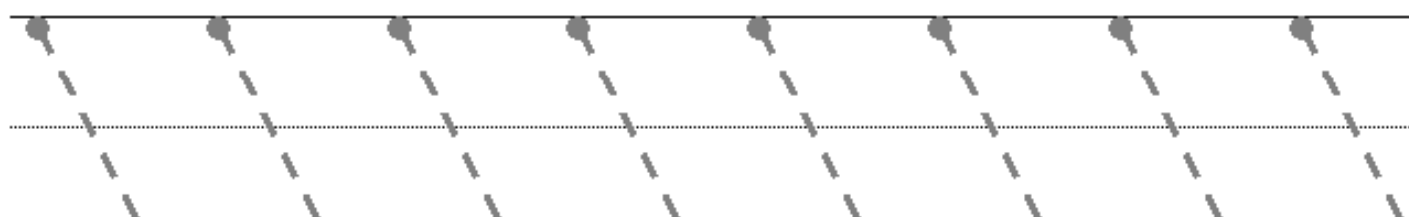
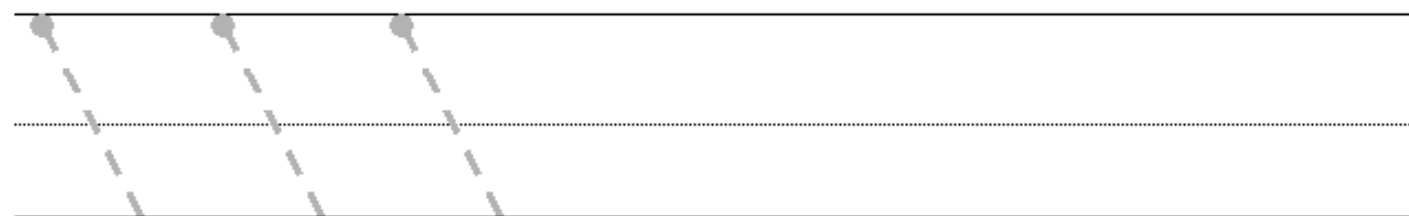
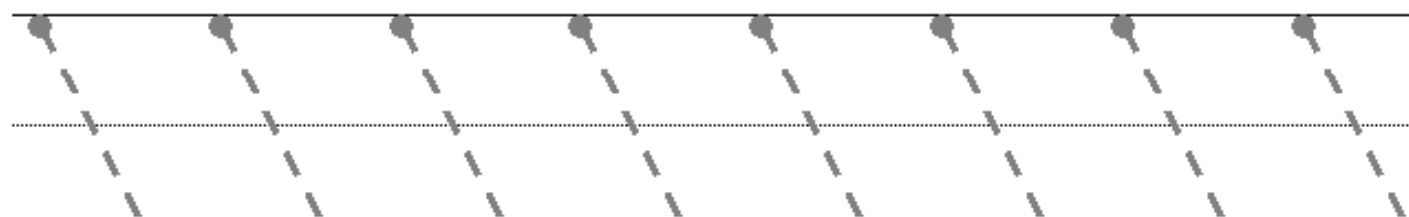
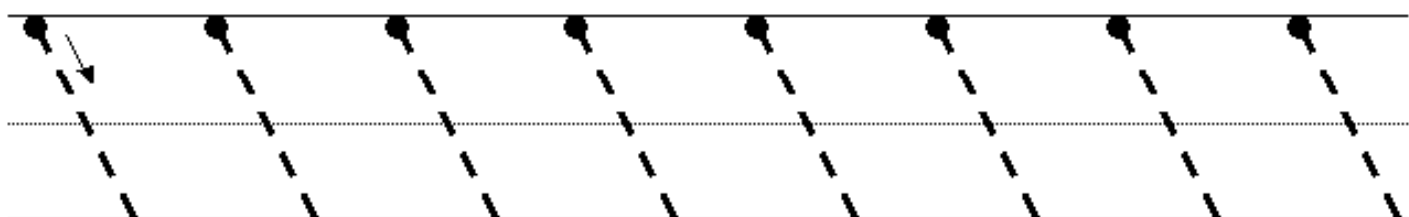

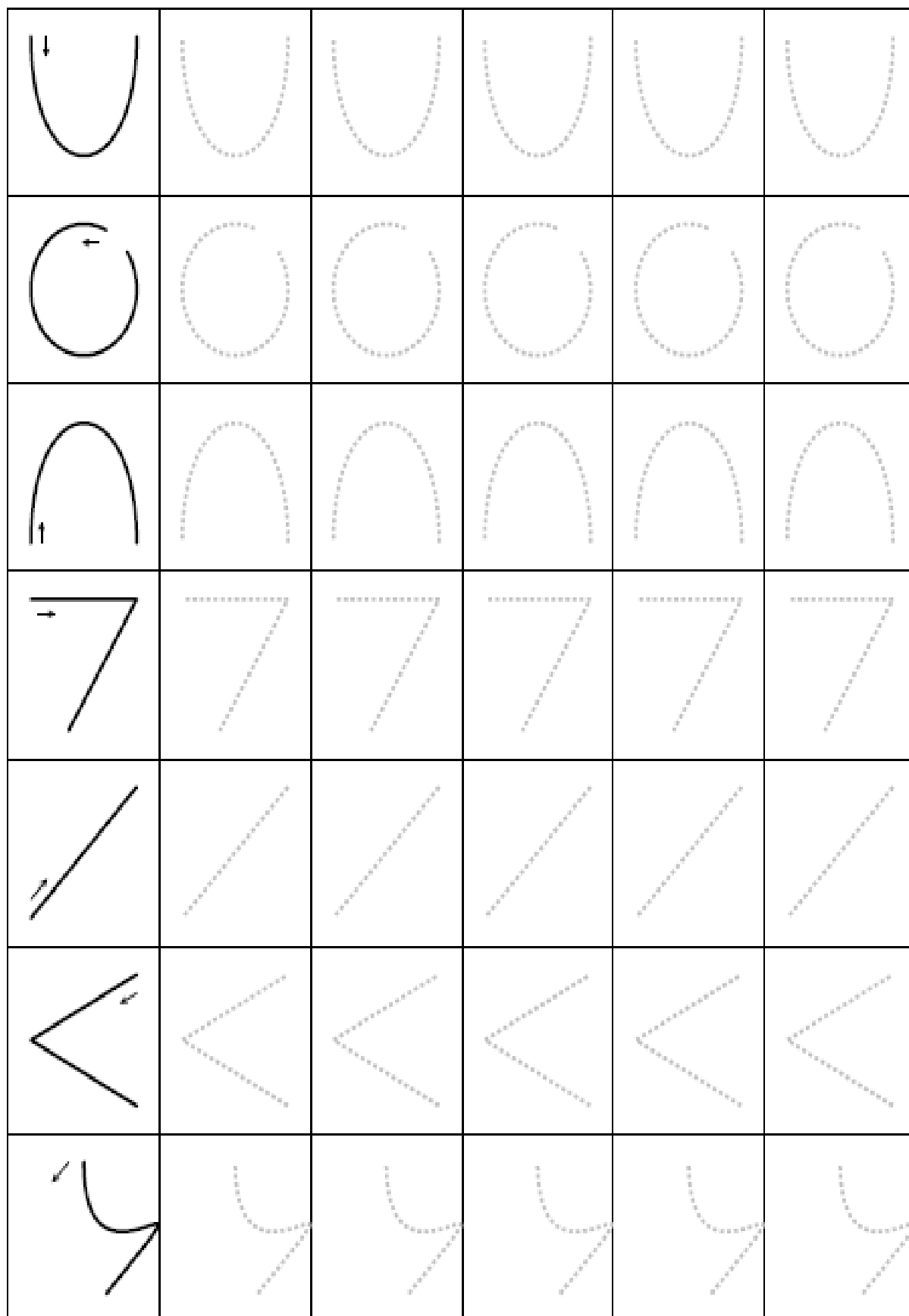







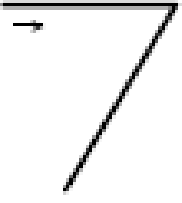









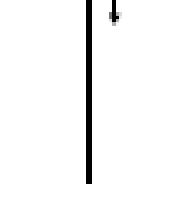
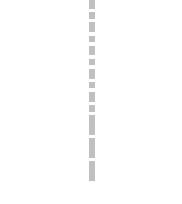
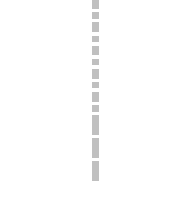
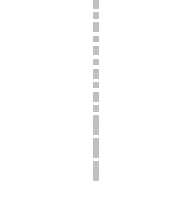
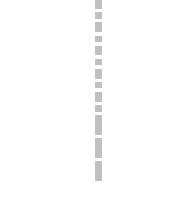
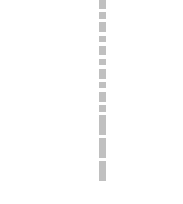

GRAFOMOTRICIDAD





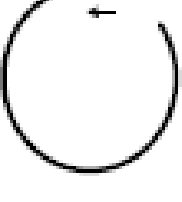
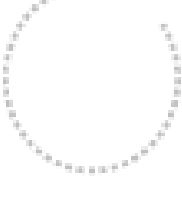
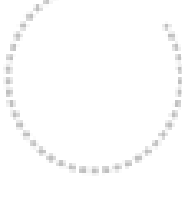
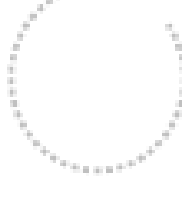
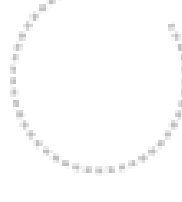



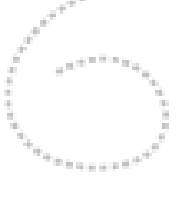
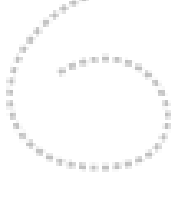
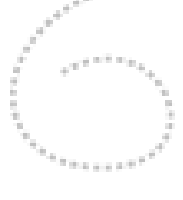

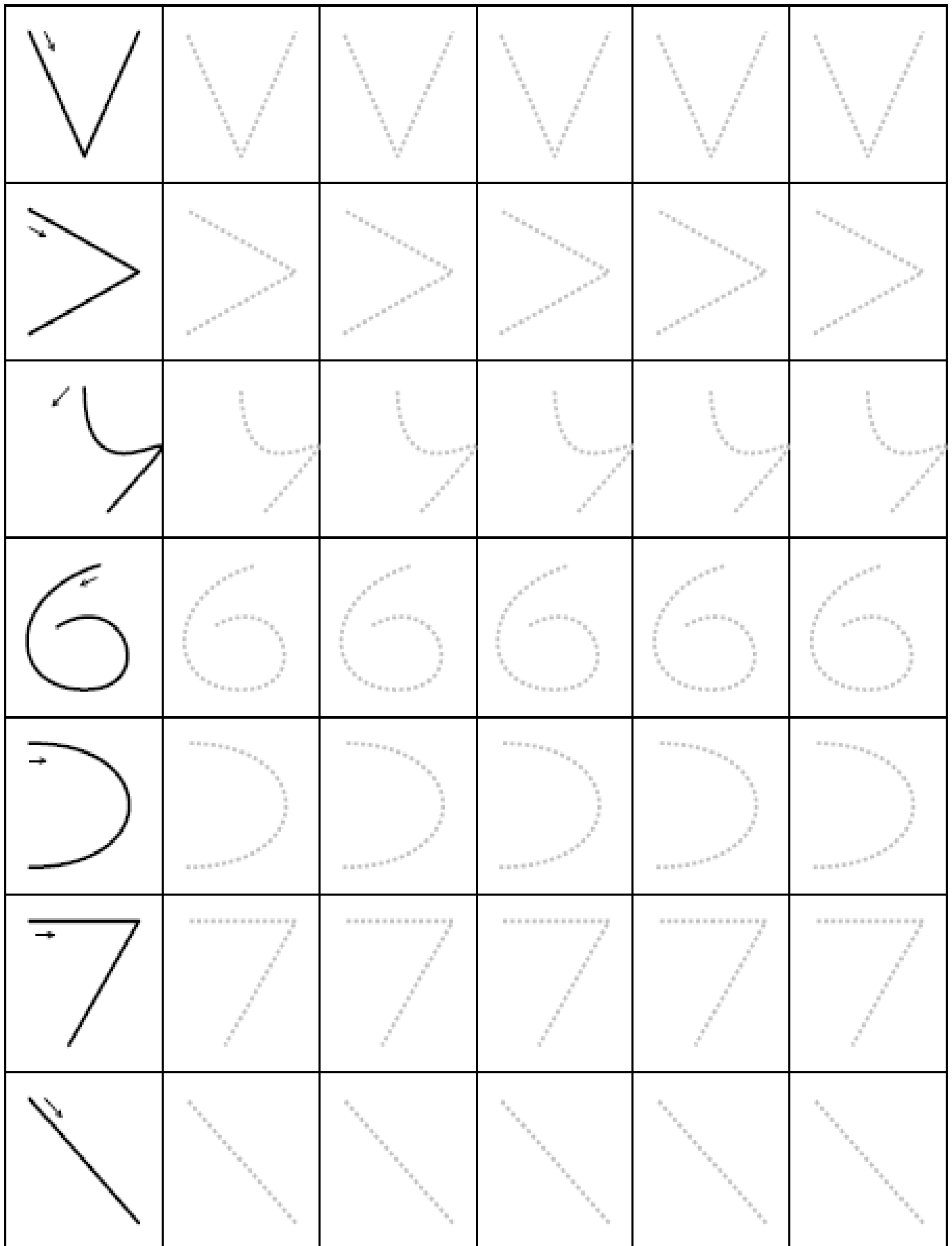

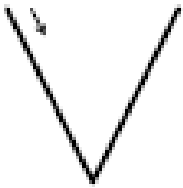

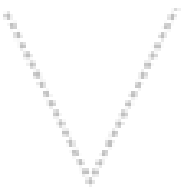

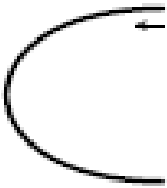





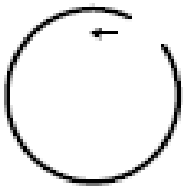
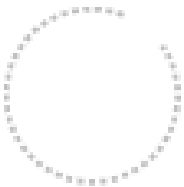
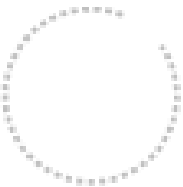
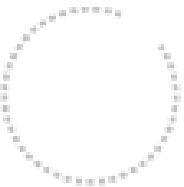
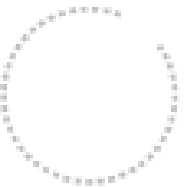
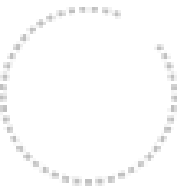
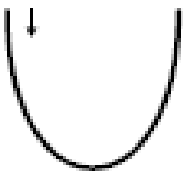









GRAFOMOTRICIDAD

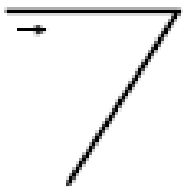
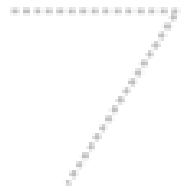
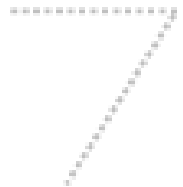
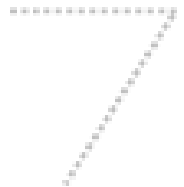

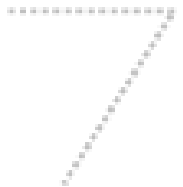













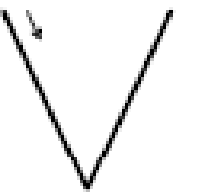





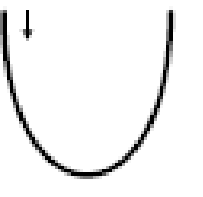





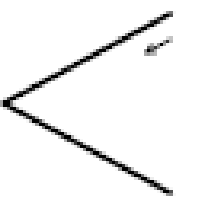





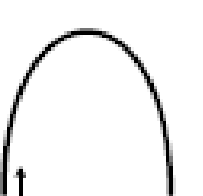
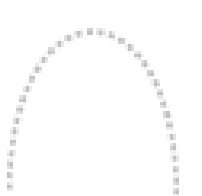
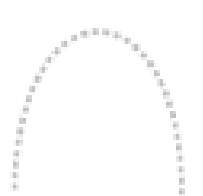
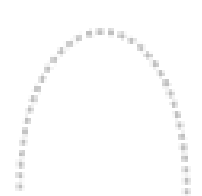
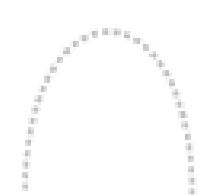
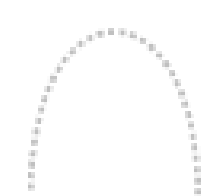
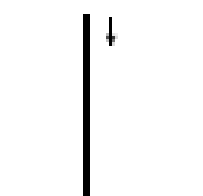
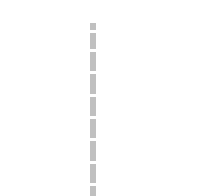
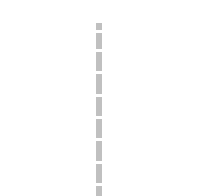
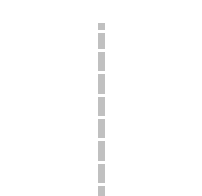
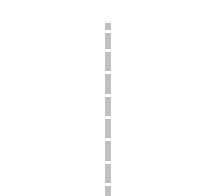
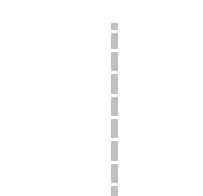
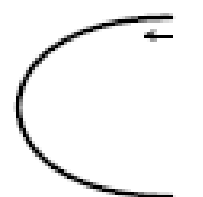
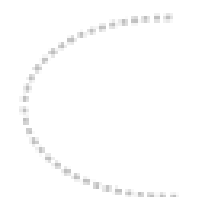
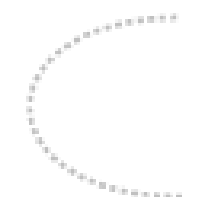





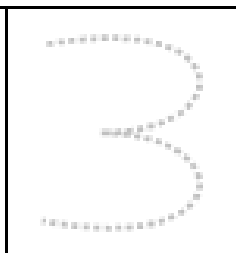
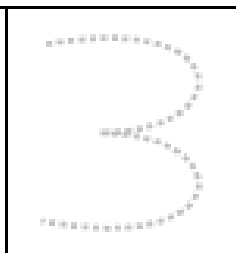
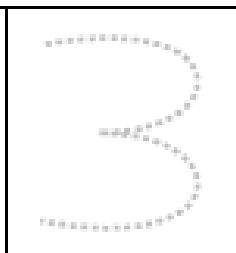
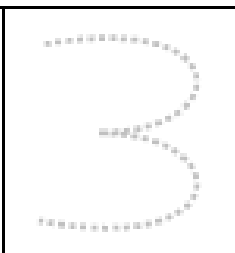
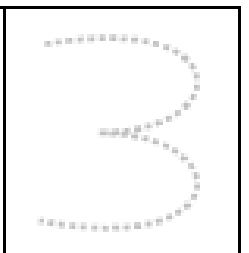
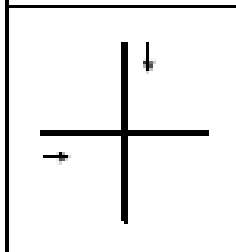
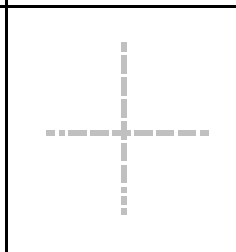
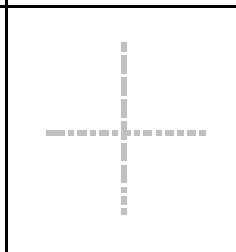
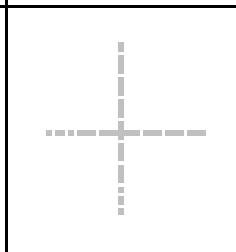
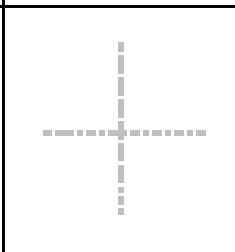
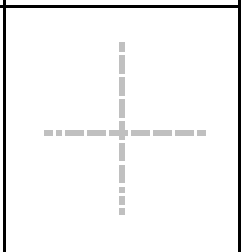
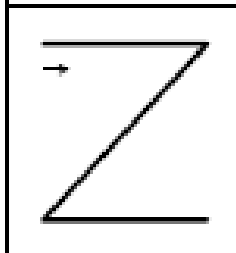
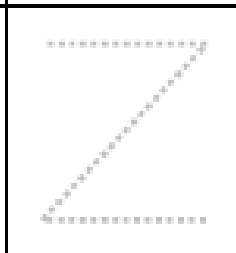
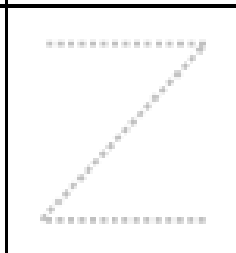
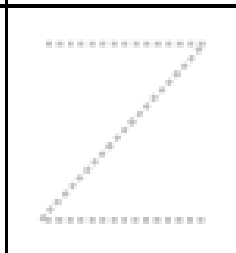
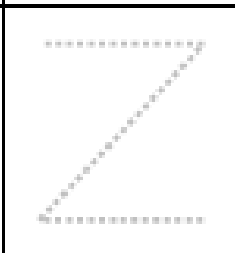
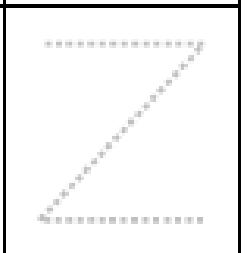
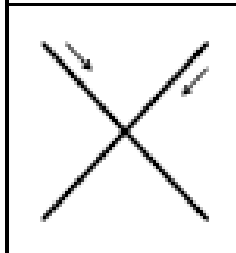
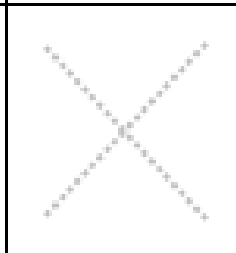
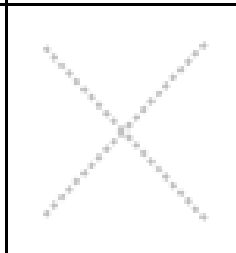
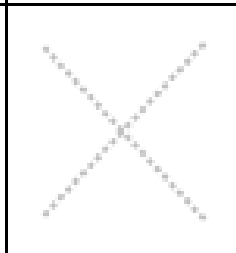
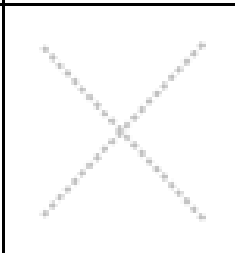
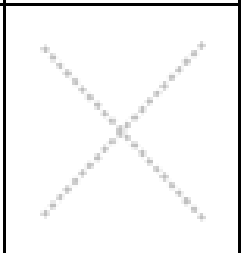
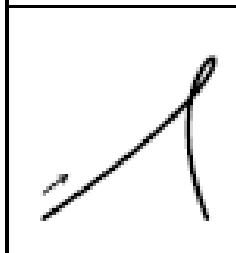
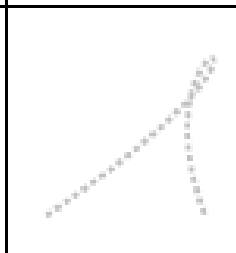
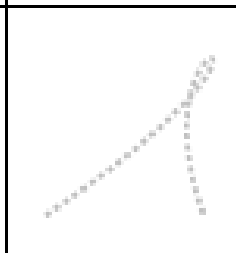
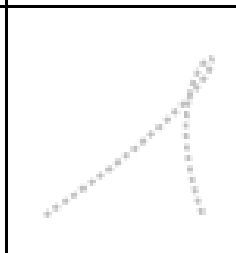
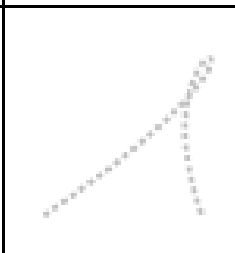
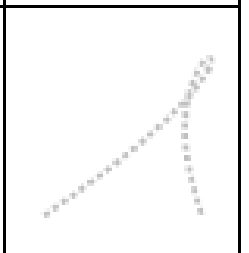
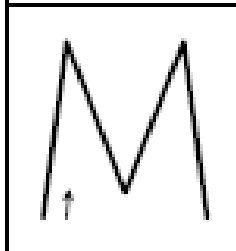
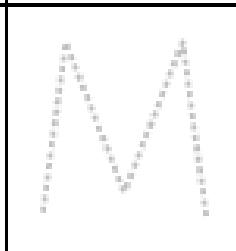
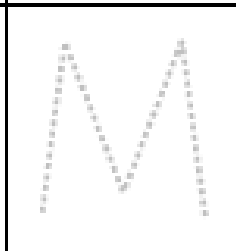
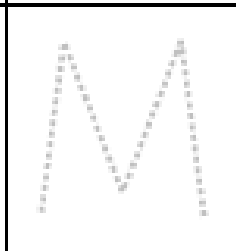
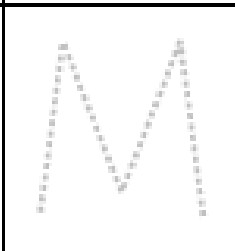
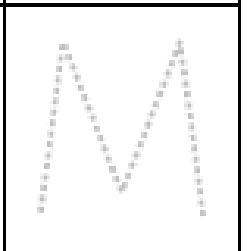
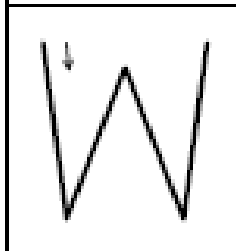
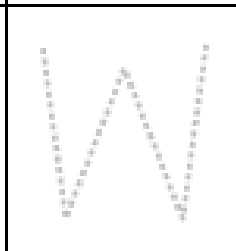
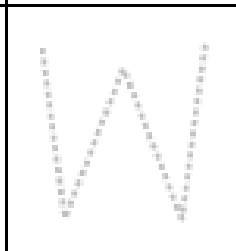
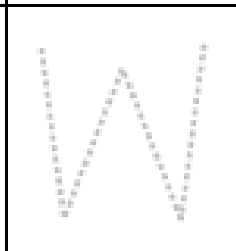
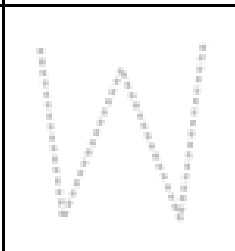
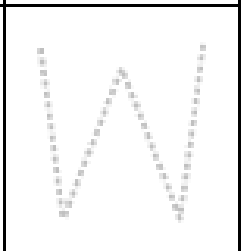

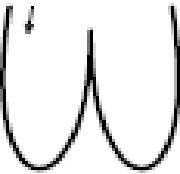

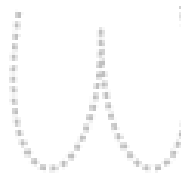







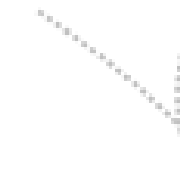





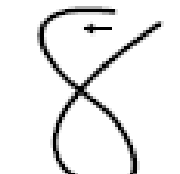
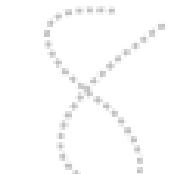
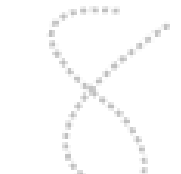
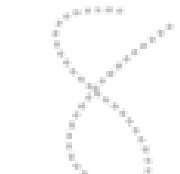









					
					
					
					
					
					
					



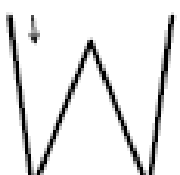







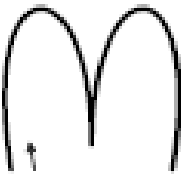
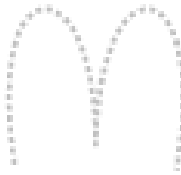



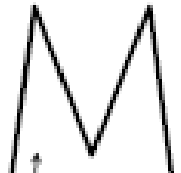





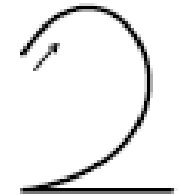
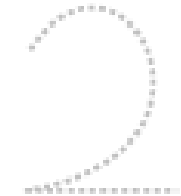
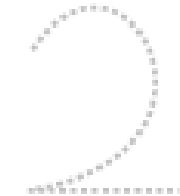

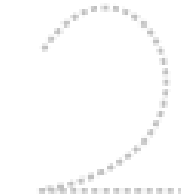





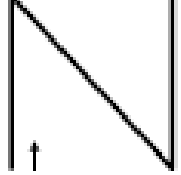

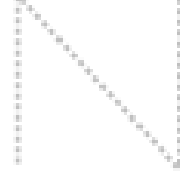

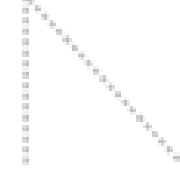

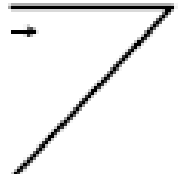





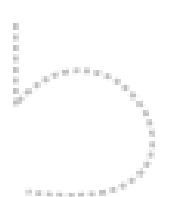
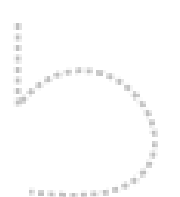
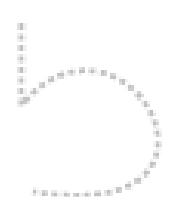
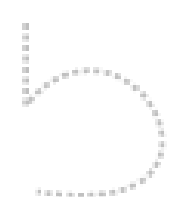
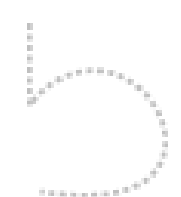



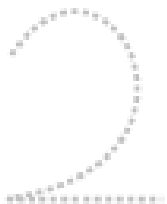
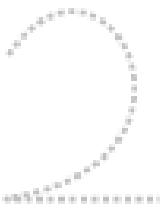



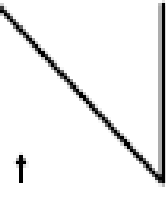

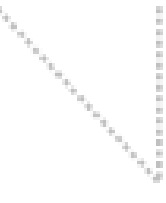

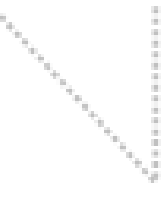
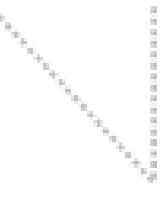









					
					
					
					
					
					
					

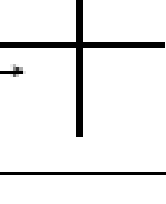
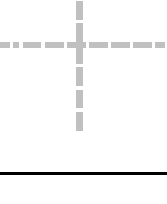
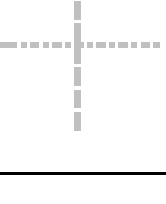
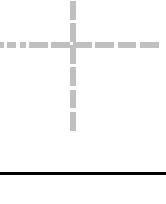
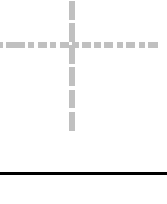
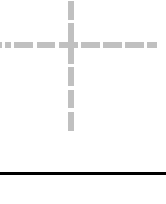

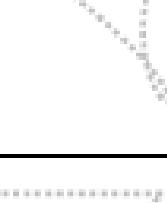
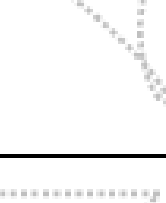
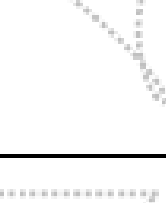
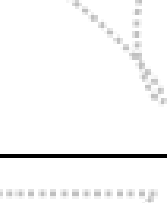
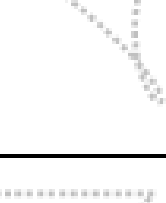



















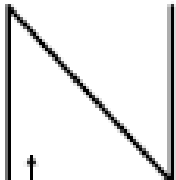



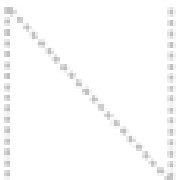

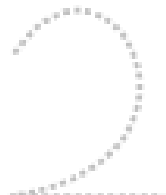
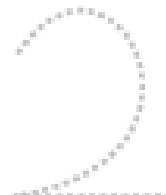









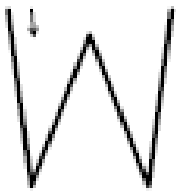

					
					
					
					
					
					
					

					
					
					
					
					
					
					

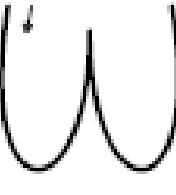







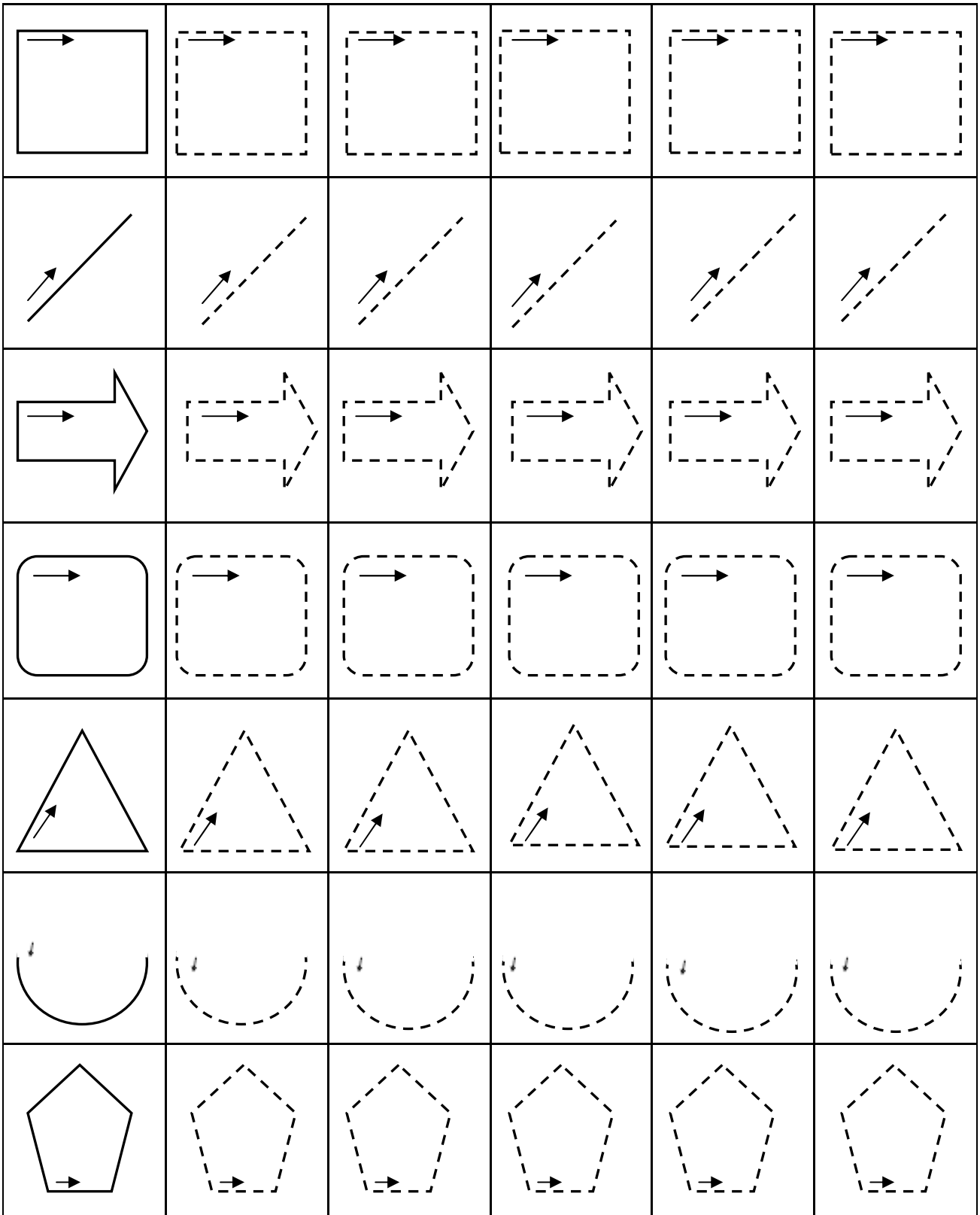



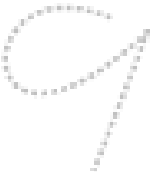
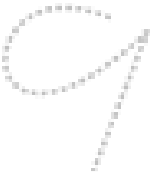
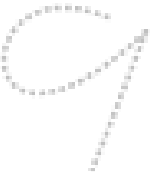



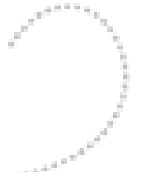

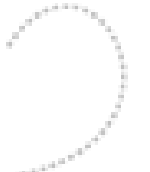
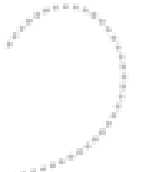
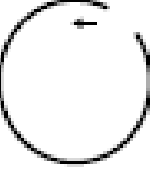
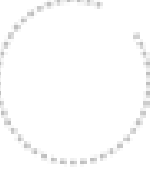

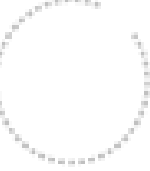















					
					
					
					
					
					
					

					
					
					
					
					
					
					









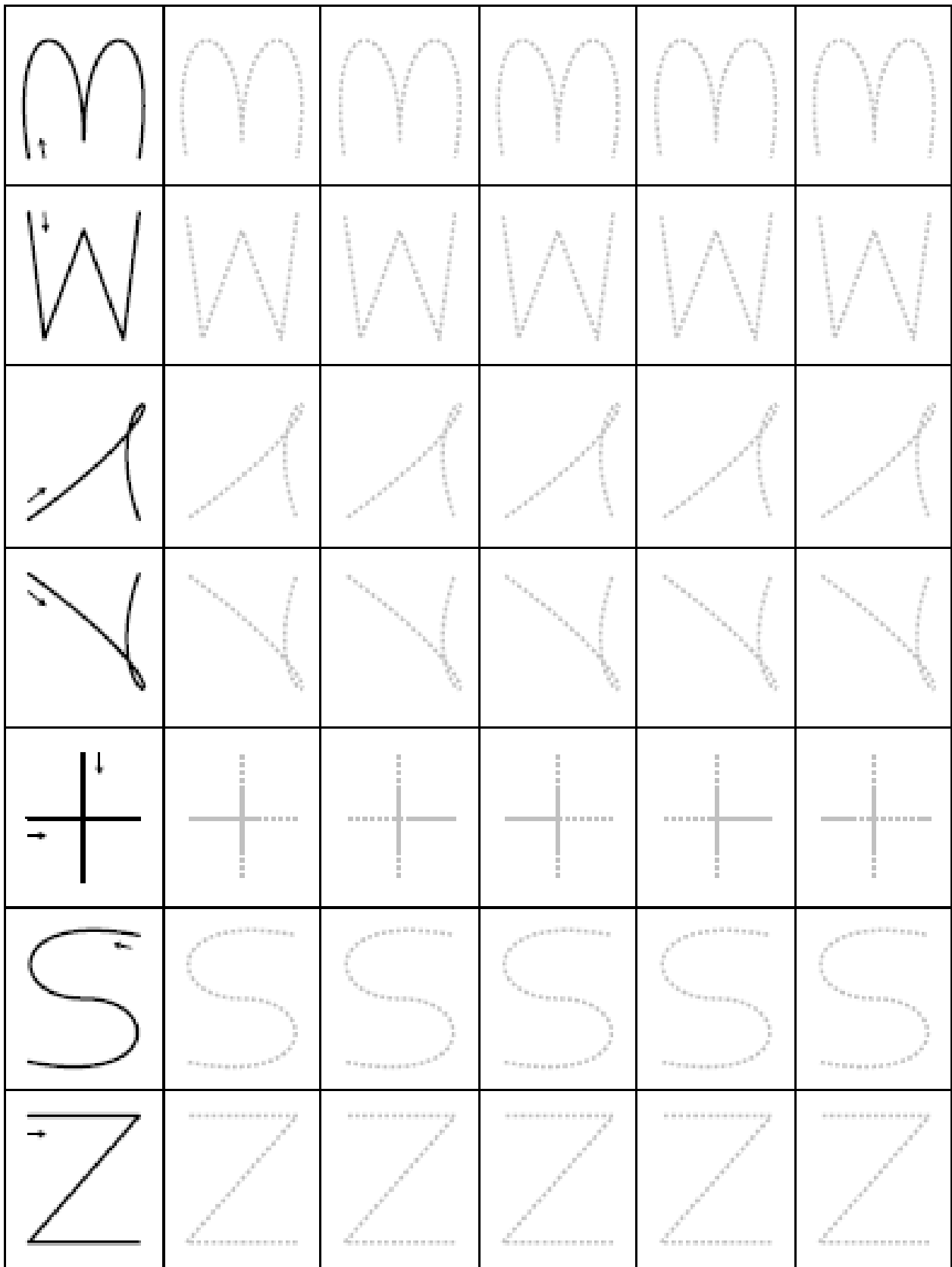

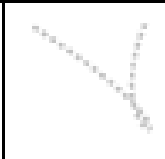
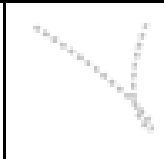
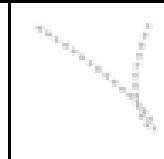
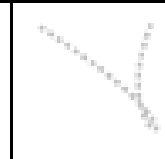
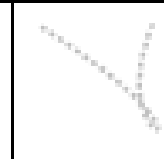
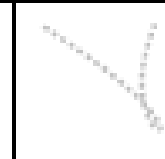
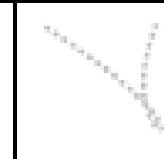

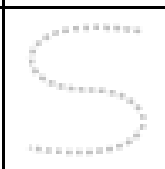
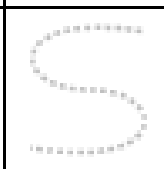
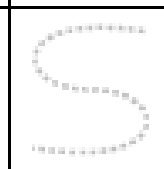
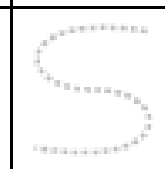
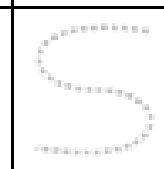
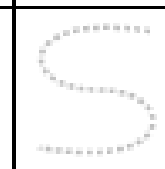
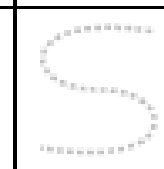

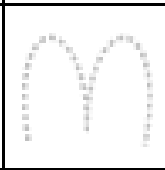
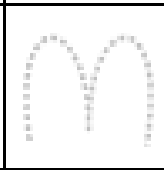
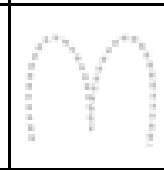
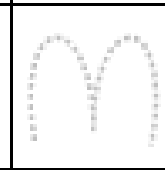
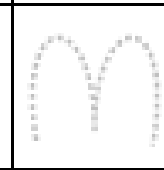
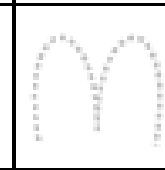
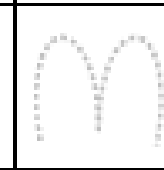

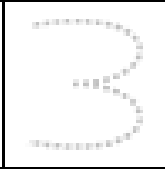
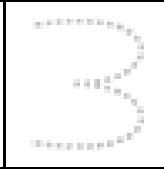
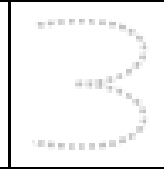
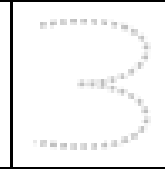
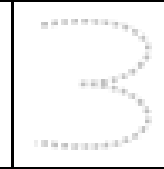
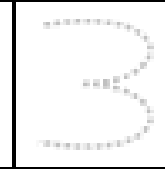
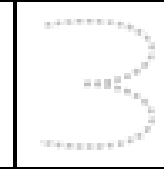
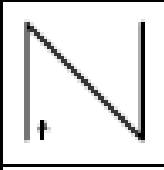
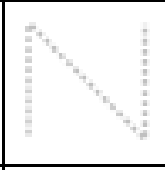
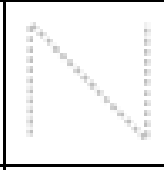
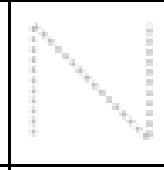
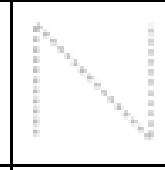
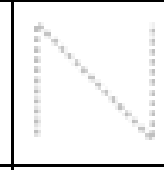
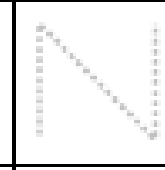
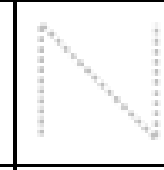

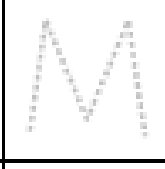
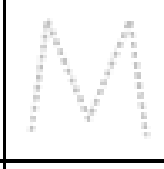
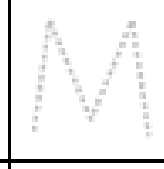
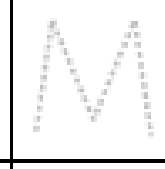
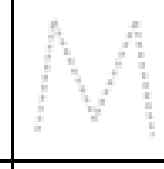
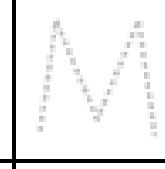
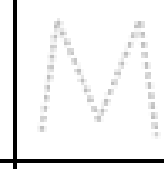
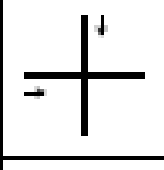
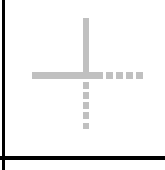
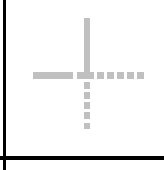
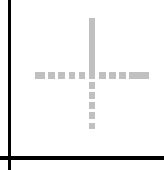
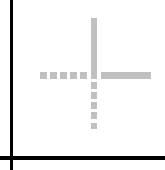
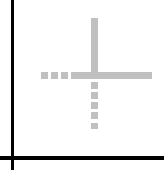
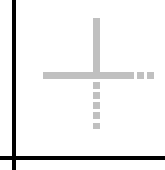
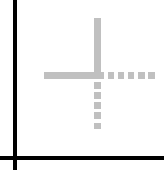
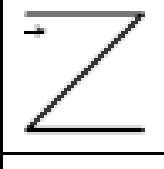
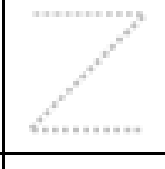
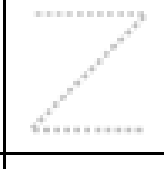
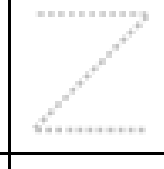
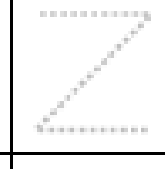
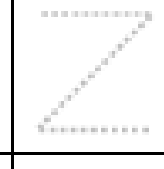
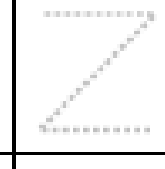
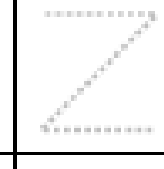
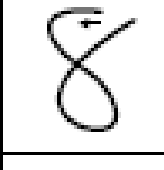
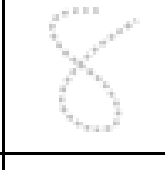
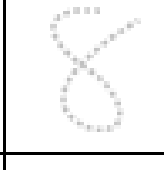
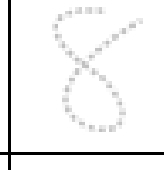
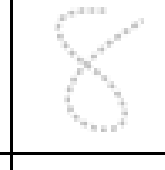
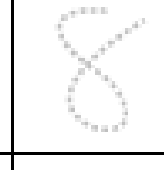
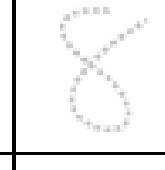
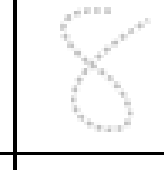



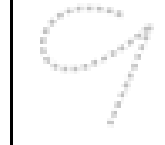
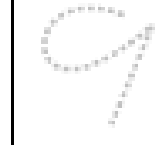
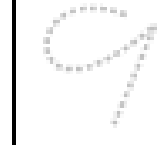
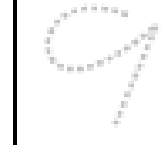

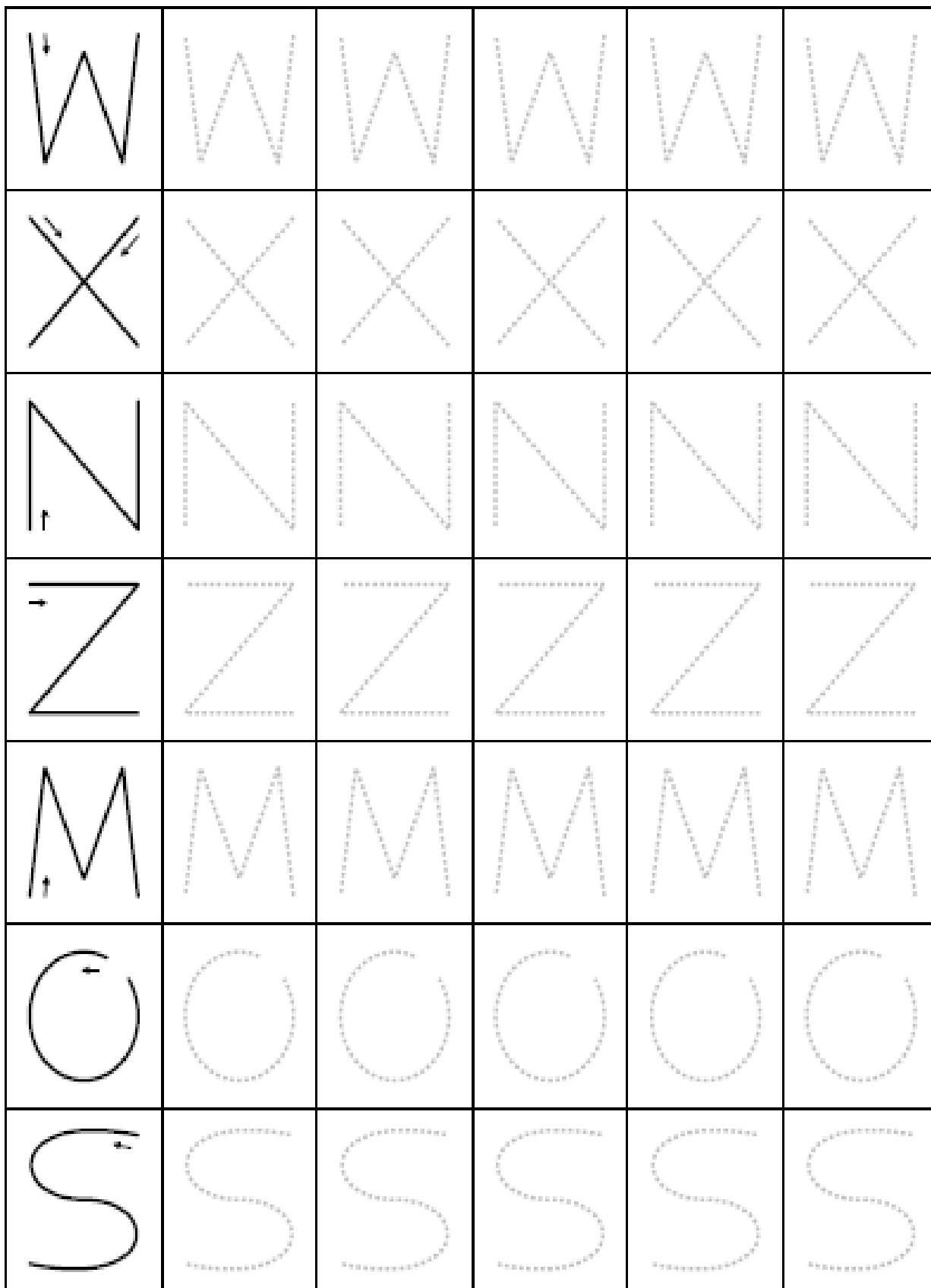









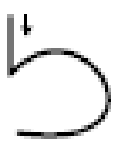















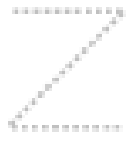
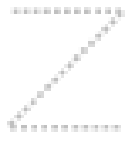











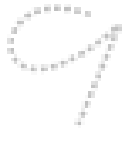

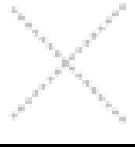
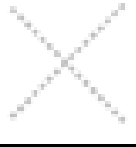
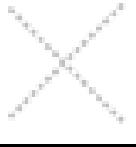
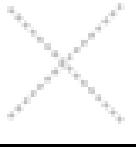
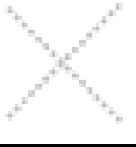
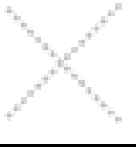
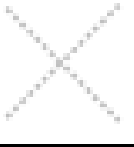







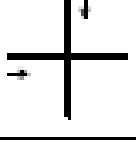
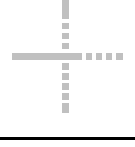
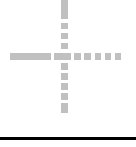
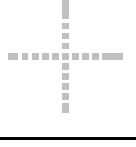
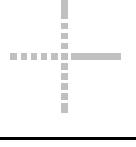
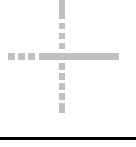
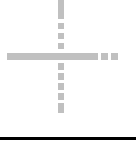
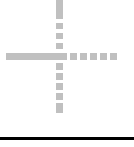





					
					
					
					
					
					
					





7	7	7	7	7	7	7	7
3	3	3	3	3	3	3	3
5	5	5	5	5	5	5	5
9	9	9	9	9	9	9	9
8	8	8	8	8	8	8	8
6	6	6	6	6	6	6	6
0	0	0	0	0	0	0	0
2	2	2	2	2	2	2	2
1	1	1	1	1	1	1	1
7	7	7	7	7	7	7	7





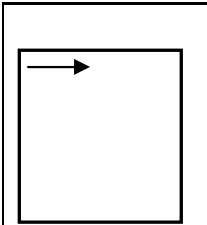
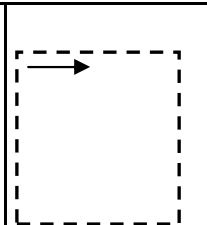
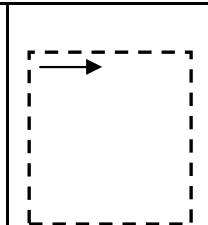
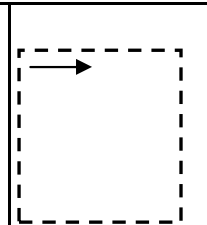
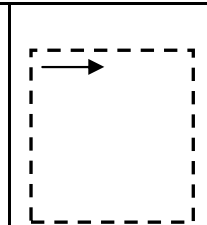
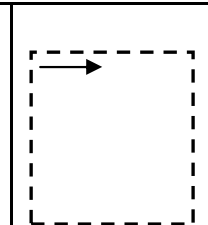
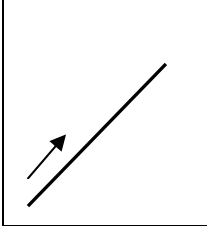
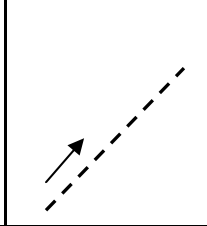
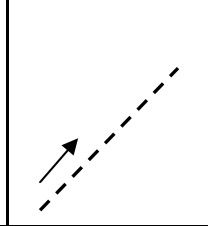
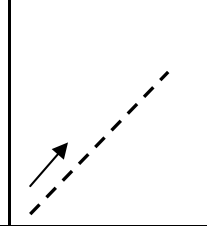
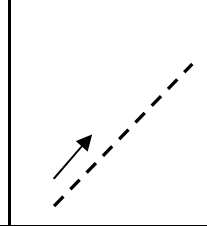
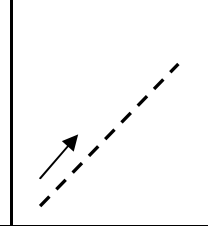
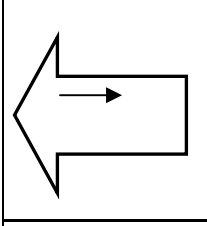
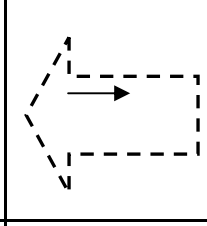
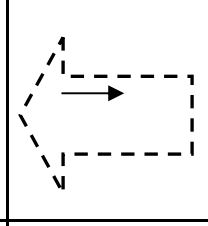
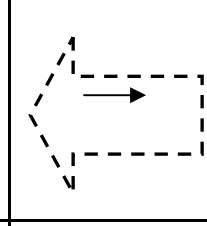
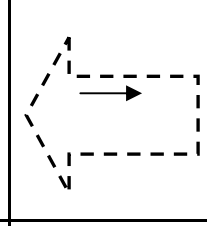
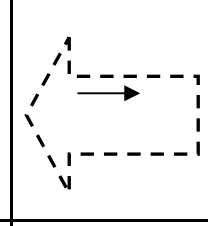
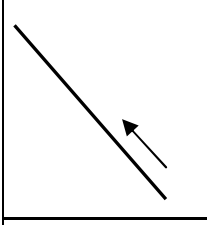
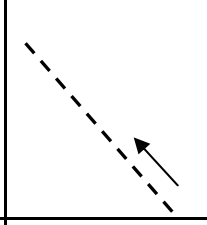
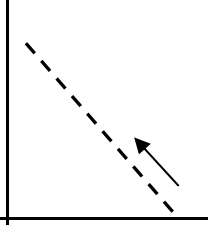
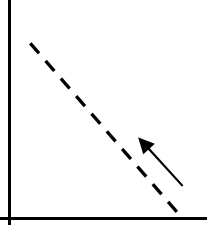
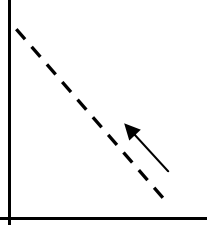
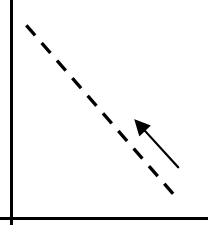
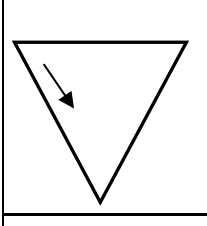
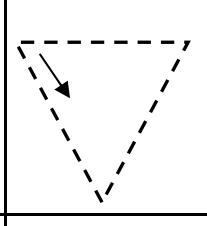
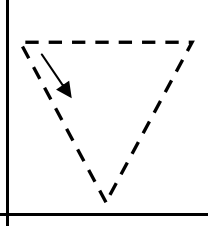
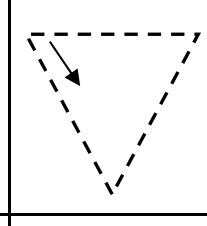
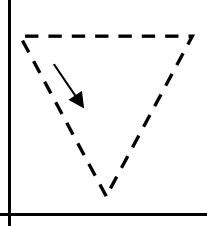
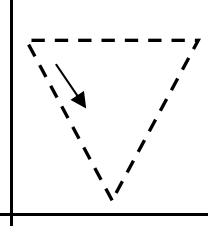
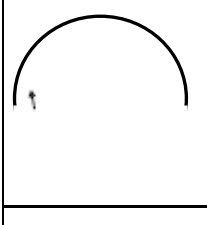
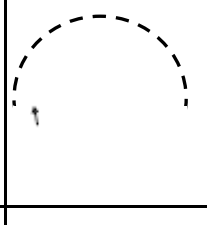
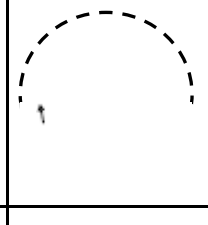
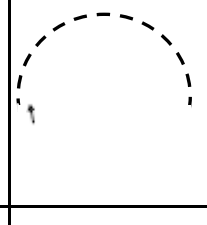
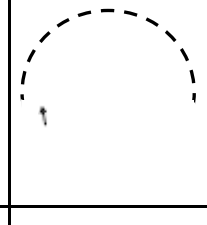
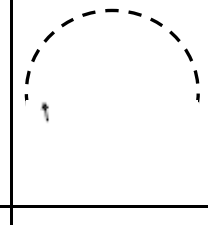
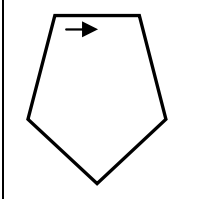
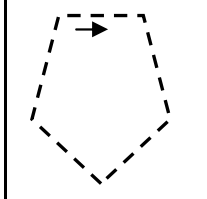
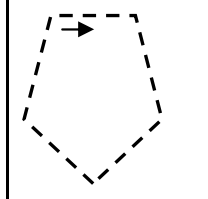
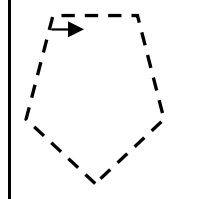
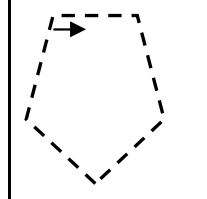
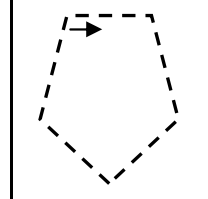

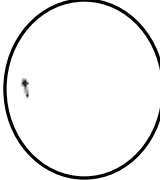
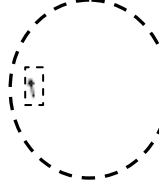
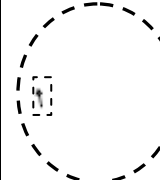
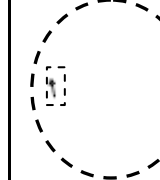
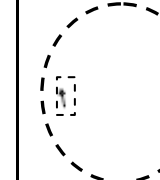
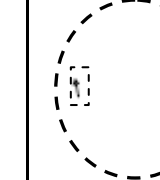
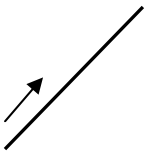
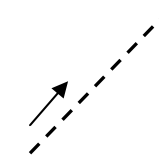
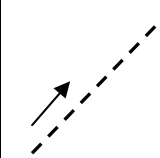
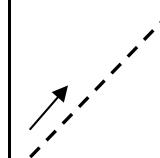
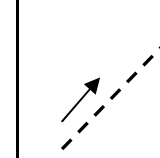
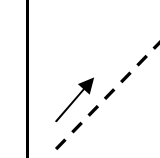
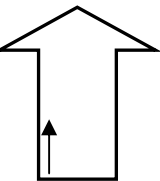
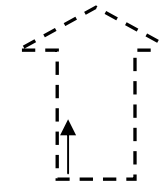
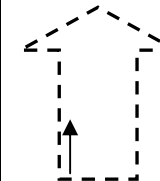
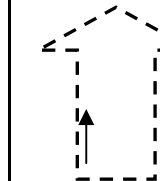
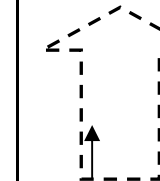
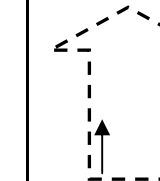
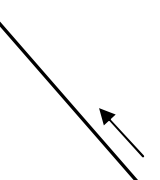
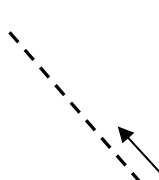
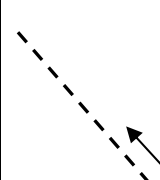
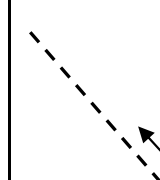
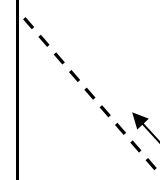
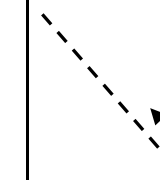
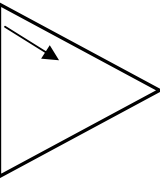
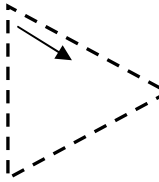
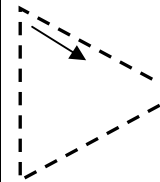
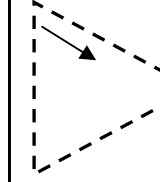
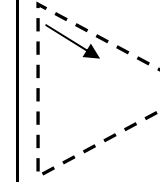
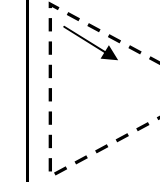
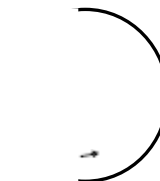

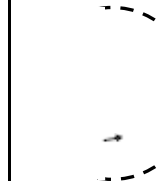
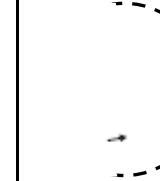
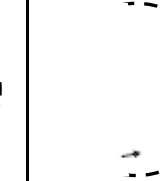
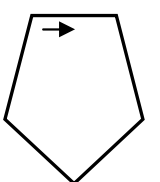
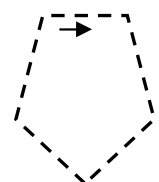
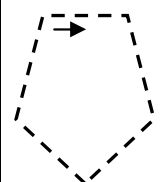
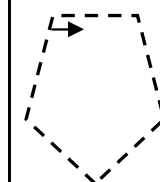
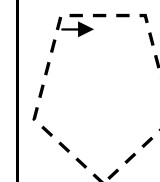
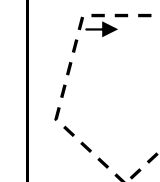



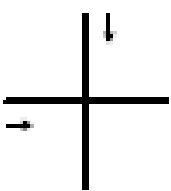
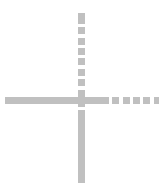
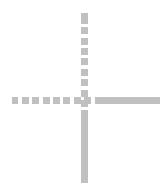
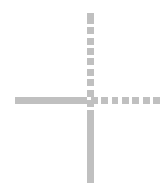
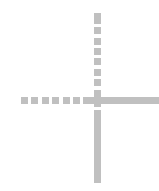
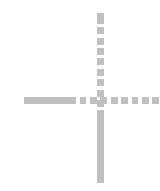



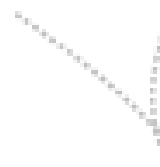







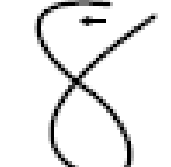
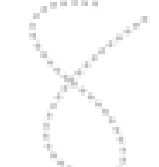
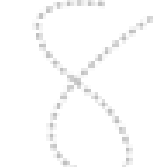
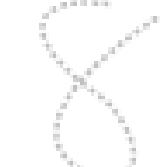

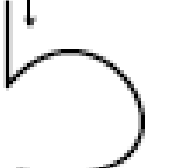

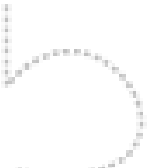
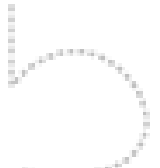
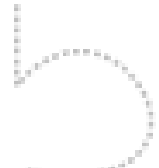
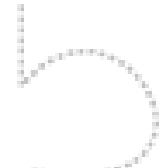

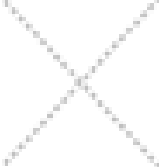

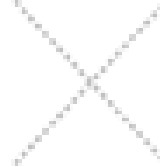

























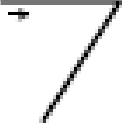
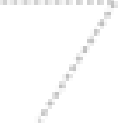



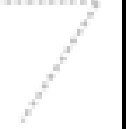
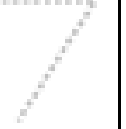







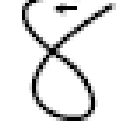



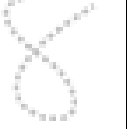
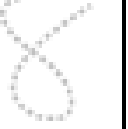
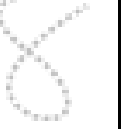



























					
					
					
					
					
					
					

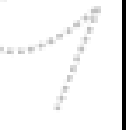
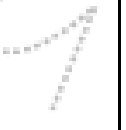



W	W	W	W	W	W	W	W	W	W
X	X	X	X	X	X	X	X	X	X
2	2	2	2	2	2	2	2	2	2
9	9	9	9	9	9	9	9	9	9
w	w	w	w	w	w	w	w	w	w
N	N	N	N	N	N	N	N	N	N
m	m	m	m	m	m	m	m	m	m
l	l	l	l	l	l	l	l	l	l
+	+	+	+	+	+	+	+	+	+
M	M	M	M	M	M	M	M	M	M
Y	Y	Y	Y	Y	Y	Y	Y	Y	Y
5	5	5	5	5	5	5	5	5	5

M	M	M	M	M	M	M	M
O	O	O	O	O	O	O	O
+	+	+	+	+	+	+	+
S	S	S	S	S	S	S	S
Y	Y	Y	Y	Y	Y	Y	Y
Z	Z	Z	Z	Z	Z	Z	Z
Z	Z	Z	Z	Z	Z	Z	Z
m	m	m	m	m	m	m	m
y	y	y	y	y	y	y	y
w	w	w	w	w	w	w	w

Y	Y	Y	Y	Y	Y	Y	Y	Y	Y
8	8	8	8	8	8	8	8	8	8
2	2	2	2	2	2	2	2	2	2
M	M	M	M	M	M	M	M	M	M
w	w	w	w	w	w	w	w	w	w
Y	Y	Y	Y	Y	Y	Y	Y	Y	Y
m	m	m	m	m	m	m	m	m	m
S	S	S	S	S	S	S	S	S	S
9	9	9	9	9	9	9	9	9	9
b	b	b	b	b	b	b	b	b	b
Z	Z	Z	Z	Z	Z	Z	Z	Z	Z
3	3	3	3	3	3	3	3	3	3

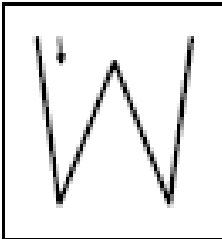
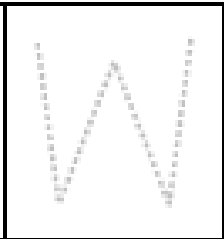
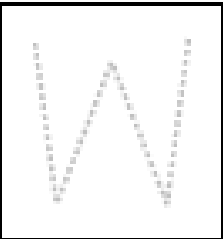
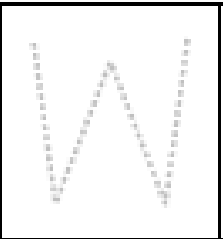
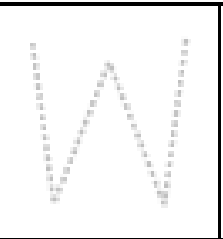

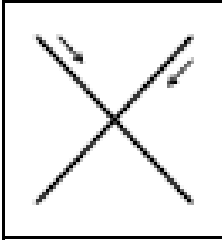
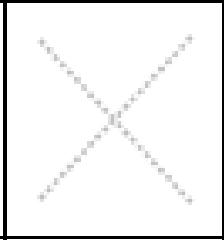
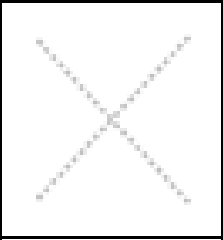
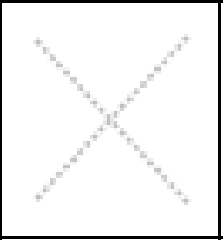
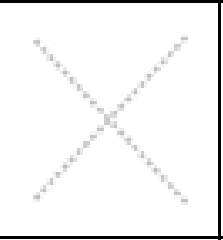
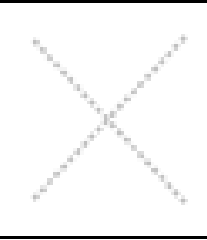
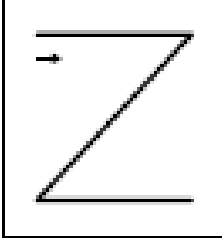
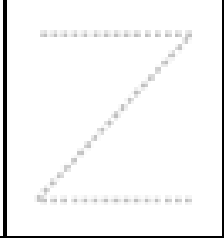
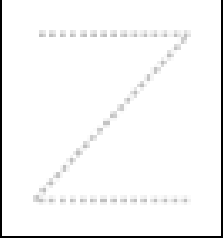
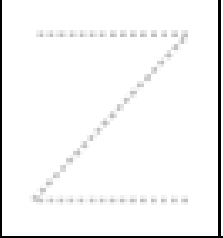
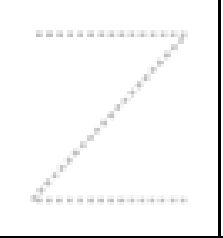
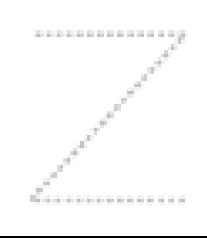
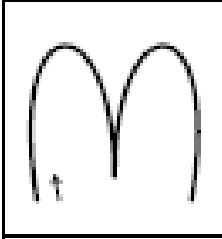
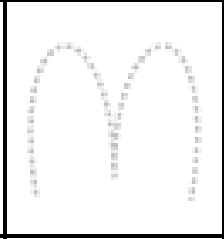
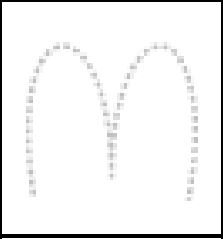
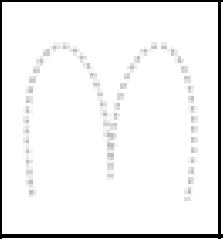
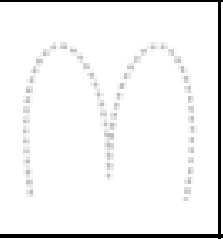
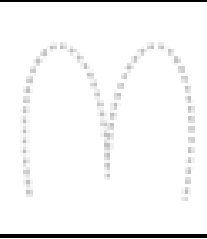
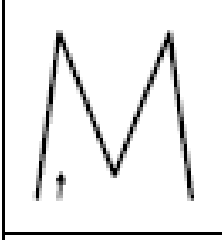
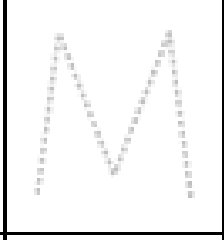
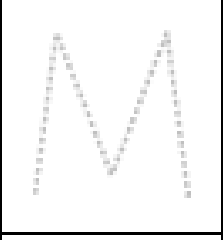
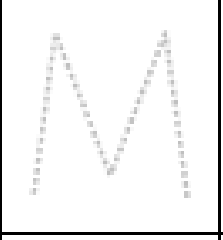
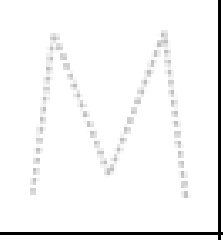

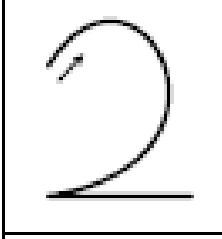
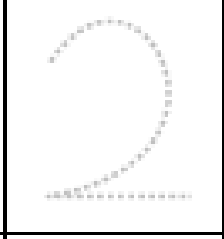
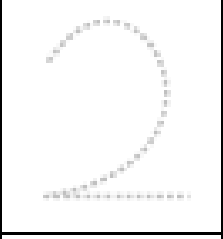
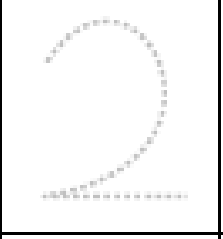
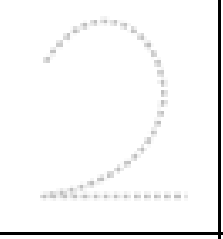
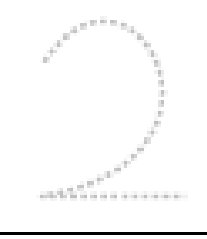
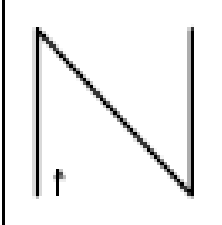
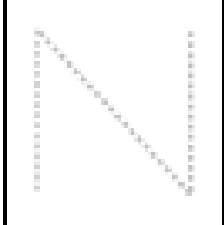
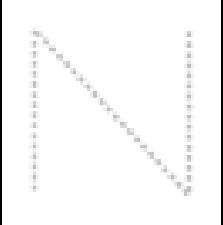
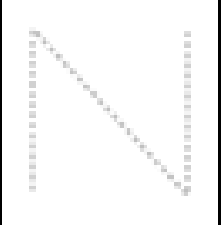
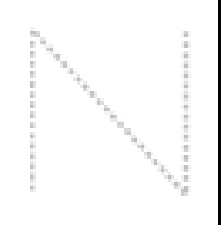
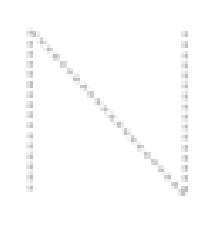
1
20
19
18
17
16
15
2
3
4
5
6
7
8
9
10
11
12
13
14

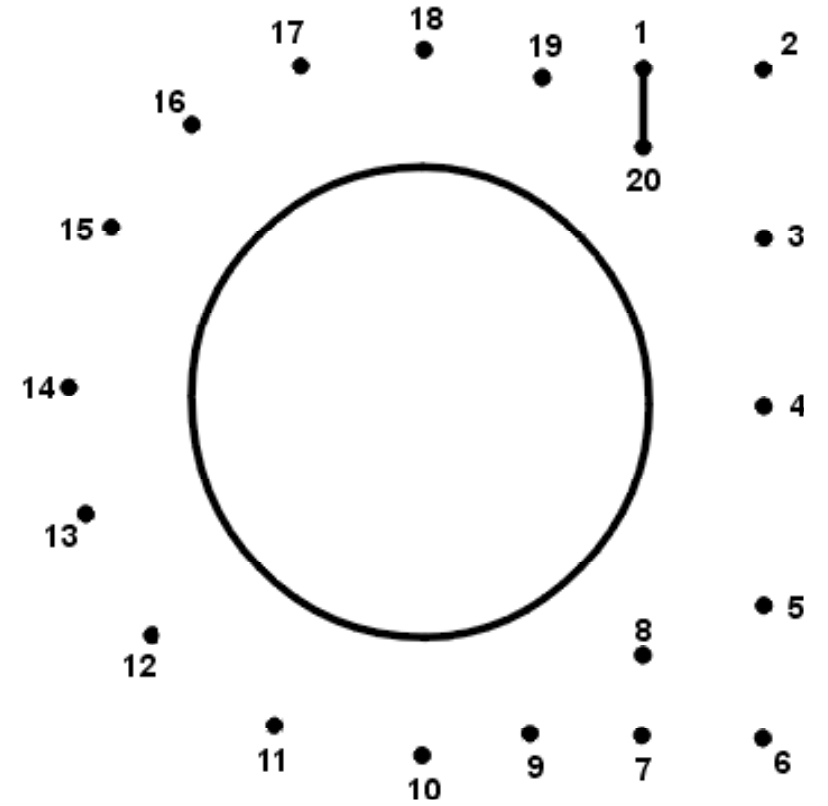
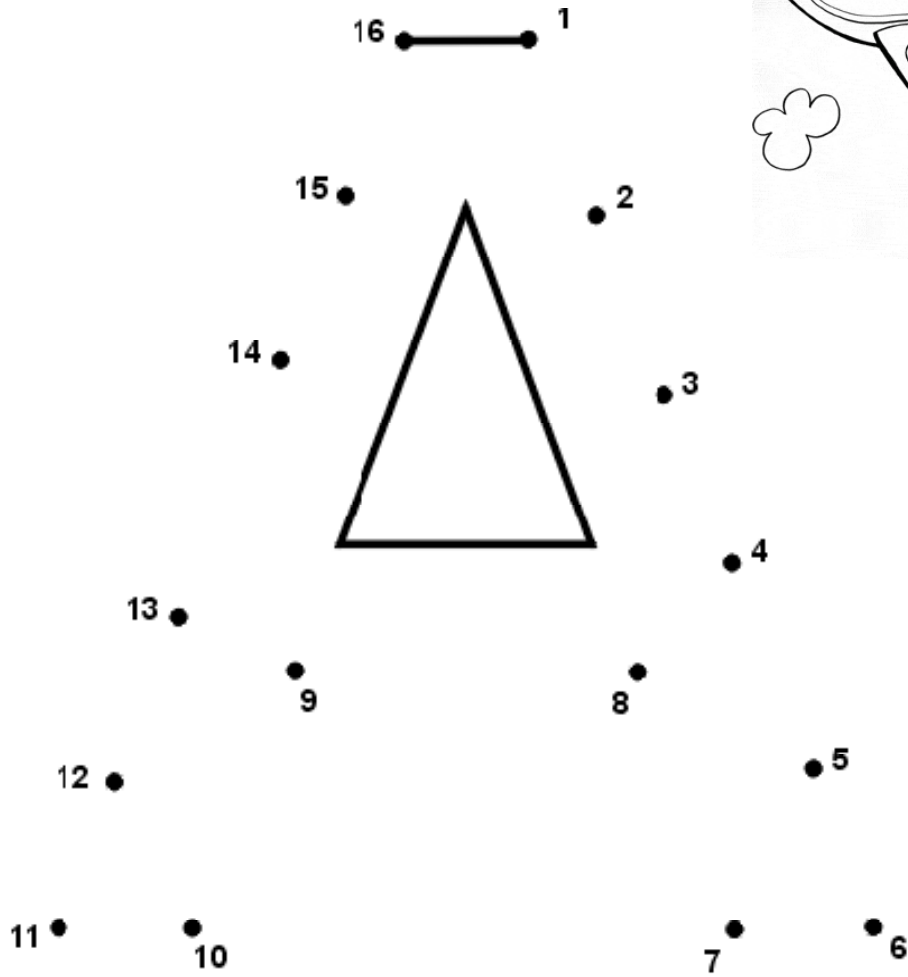
20
1
2
3
4
5
6
7
8
9
10
11
12
13
14
15
16
17
18
19

Maribel Martínez y Ginés Ciudad-Real

Fichas de grafomotricidad

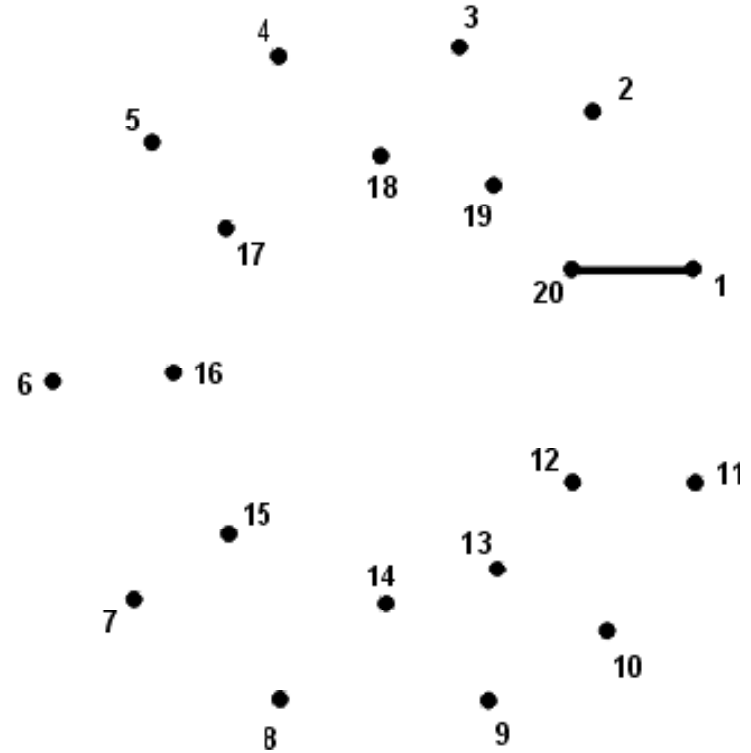
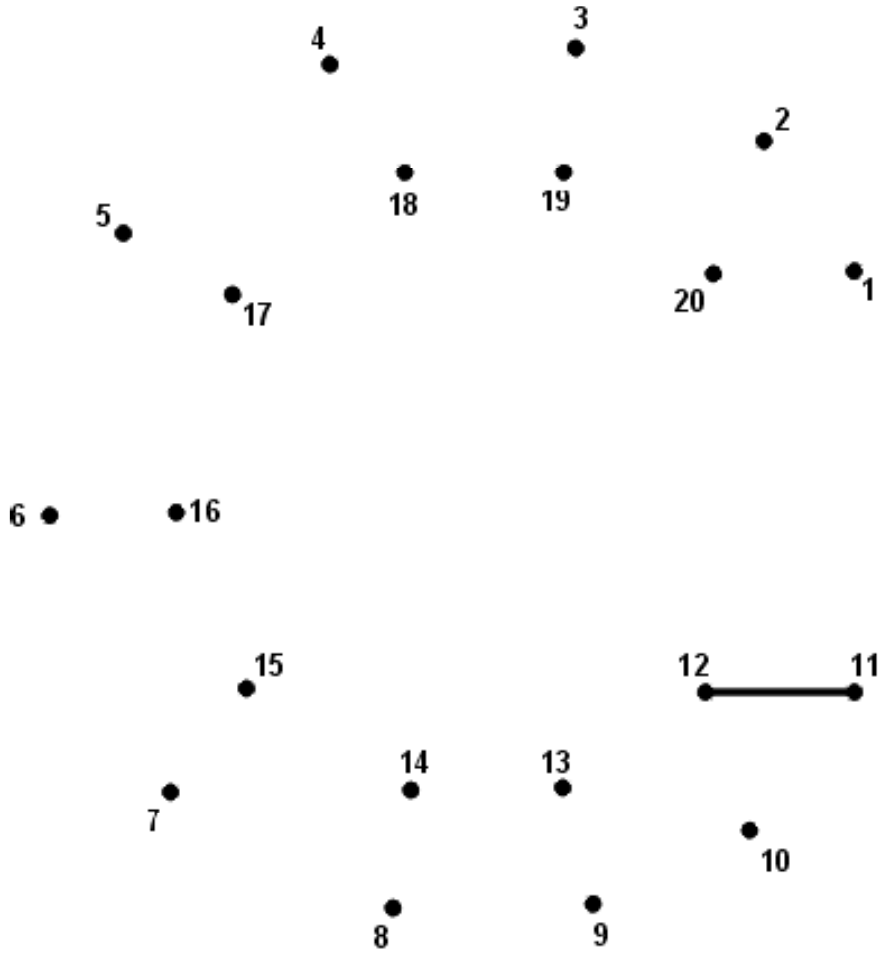
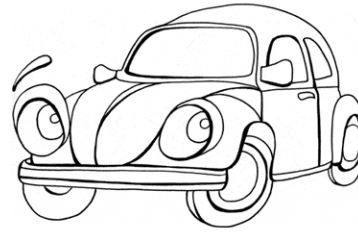

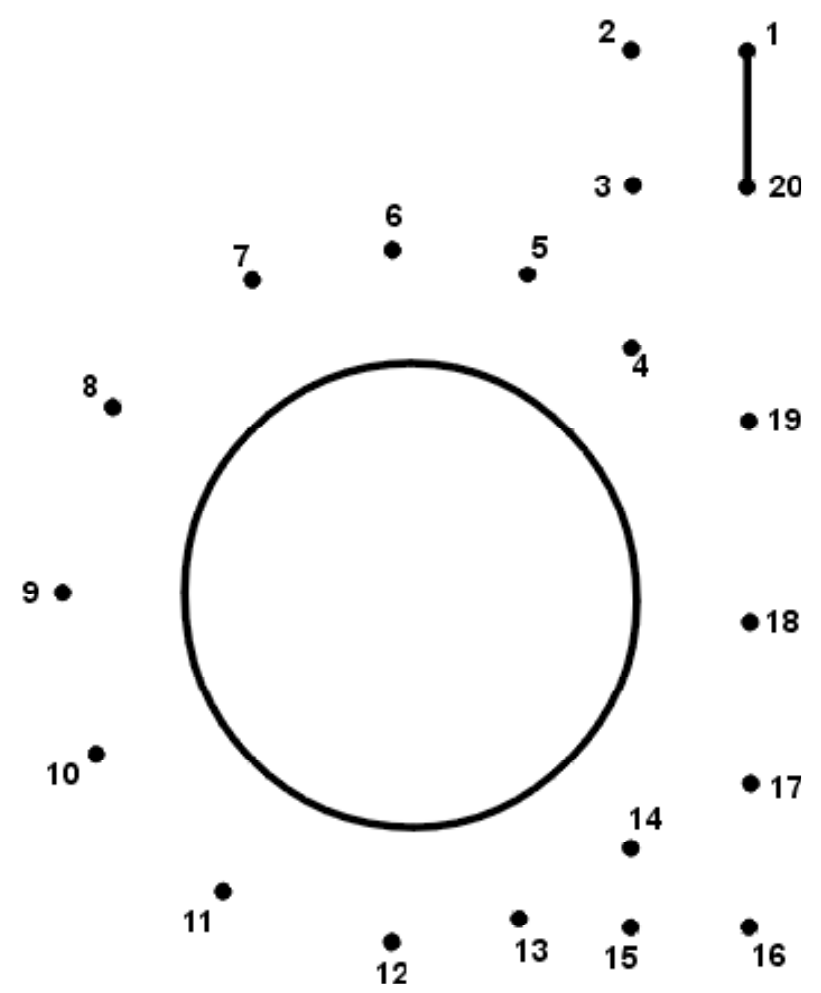
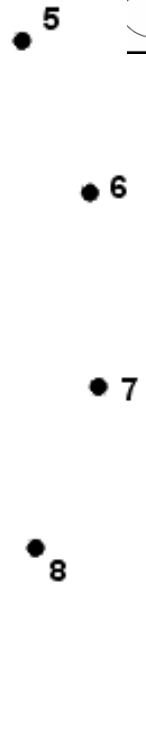
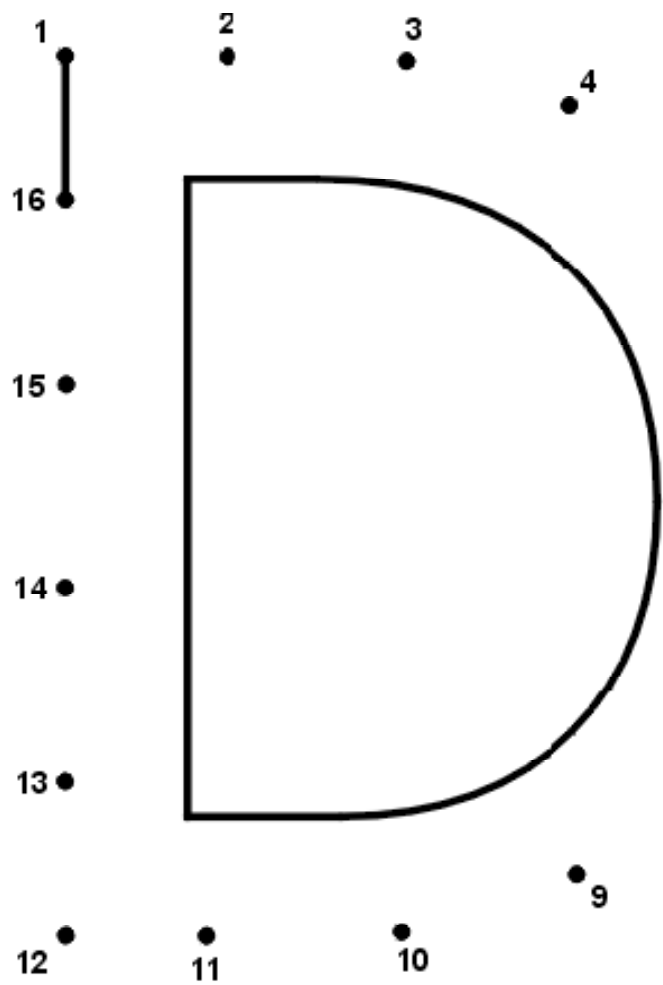

Maribel Martínez y Ginés Ciudad-Real

Fichas de grafomotricidad

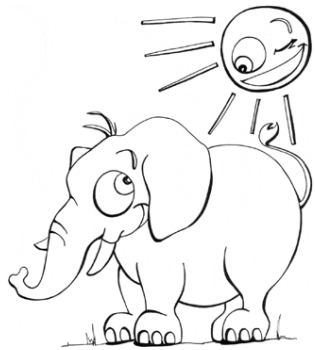

A dot-marker activity for the number 2. It consists of 20 numbered dots arranged in a grid-like pattern. A vertical line segment connects dot 1 at the top to dot 20 at the bottom, illustrating the stroke direction for writing the number 2.

A dot-marker activity for the number 1. It consists of 20 numbered dots arranged in a scattered pattern. A curved line segment connects dot 20 at the top to dot 1 at the bottom, illustrating the stroke direction for writing the number 1.

Maribel Martínez y Ginés Ciudad-Real

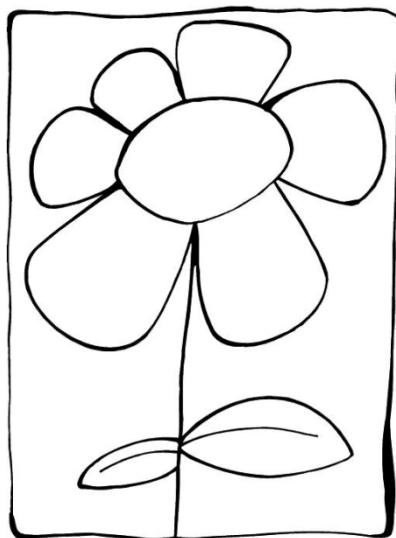
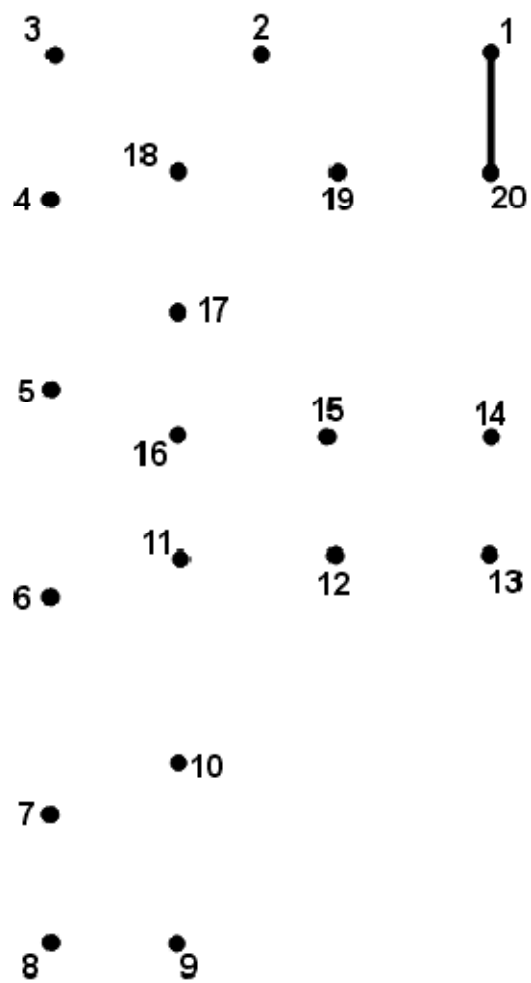

Fichas de grafomotricidad

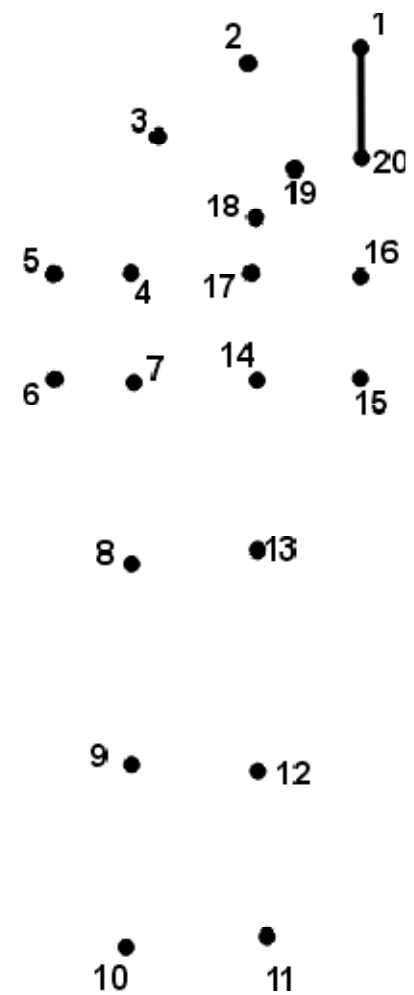

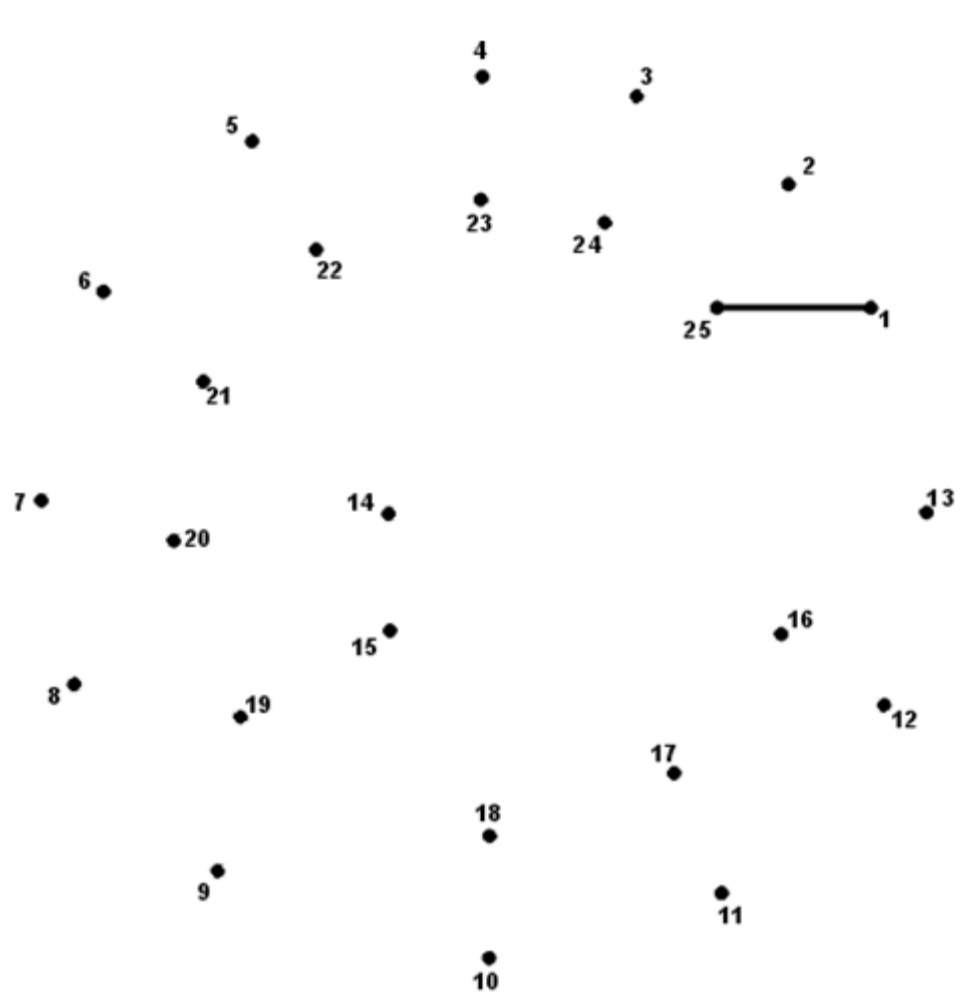



1 ————— 22

16 • • 15

22 ————— 1

• 21

17 •

21 •

2 •

• 20

• 19

18 •

• 14

• 3

• 4

• 5

• 7

• 8

• 9

• 2

• 15

• 14

• 13

• 6

3 •

• 13

20 •

• 16

• 12

• 11

• 7

• 6

10 •

19 •

• 8

4 •

• 5

11 •

• 12

18 •

• 17

10 •

• 9

12 ● ——— ● 1

11 ● ● 2

10 ● ● 3

9 ● ● 4

8 ● ● 5

7 ● ● 6

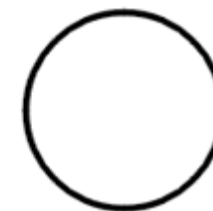

10 ● ——— ● 1

9 ● ● 2

8 ● ● 3

7 ● ● 4

6 ● ● 5



17 ————— 1

16 • • 2

15 • • 3

9 • 10 • 14 • • 4
11 • 12 • 13 •
8 • • 5
7 • 6 •



14 ————— 1

13 • • 2

12 • • 3

11 • • 4
8 • 9 • 10 •
7 • 6 • 5 •

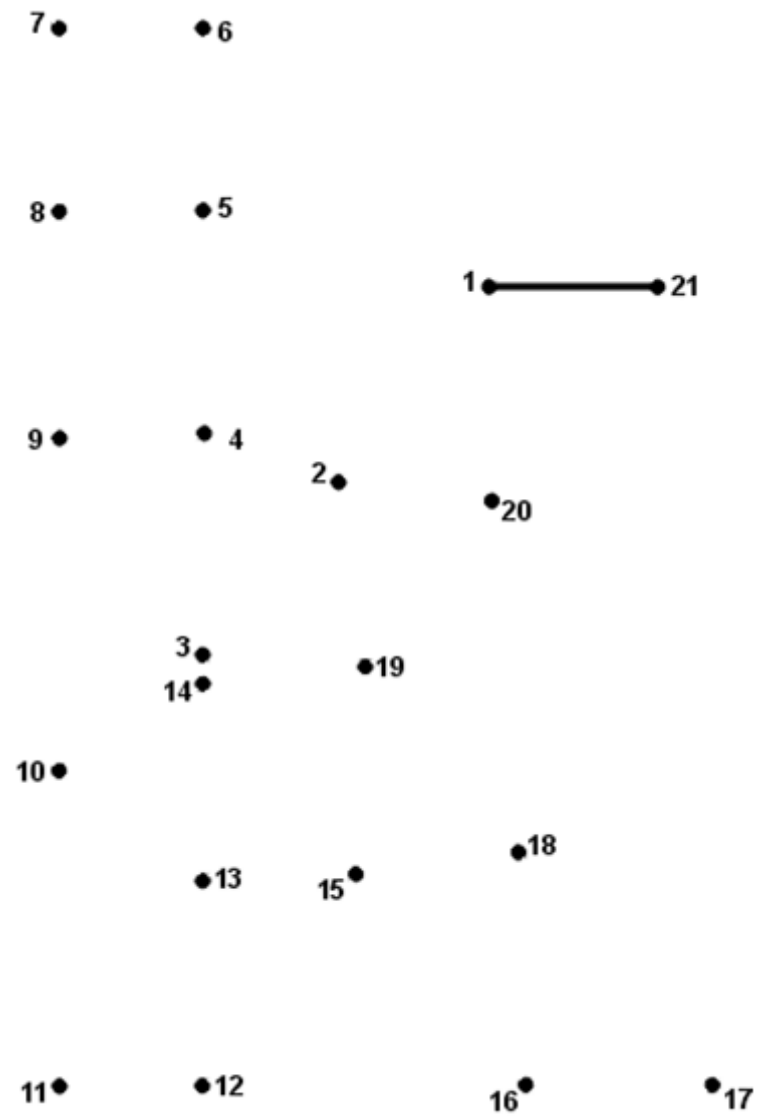

Maribel Martínez y Ginés Ciudad-Real

14 ●————● 1

13 ● ● 2

12 ● ● 3

11 ● ● 4

10 ● ● 5 ● 6

9 ● ● 8 ● 7



Fichas de grafomotricidad

1 ●————● 10

2 ● ● 9

3 ● ● 8

4 ● ● 7

5 ● ● 6

Maribel Martínez y Ginés Ciudad-Real

Fichas de grafomotricidad

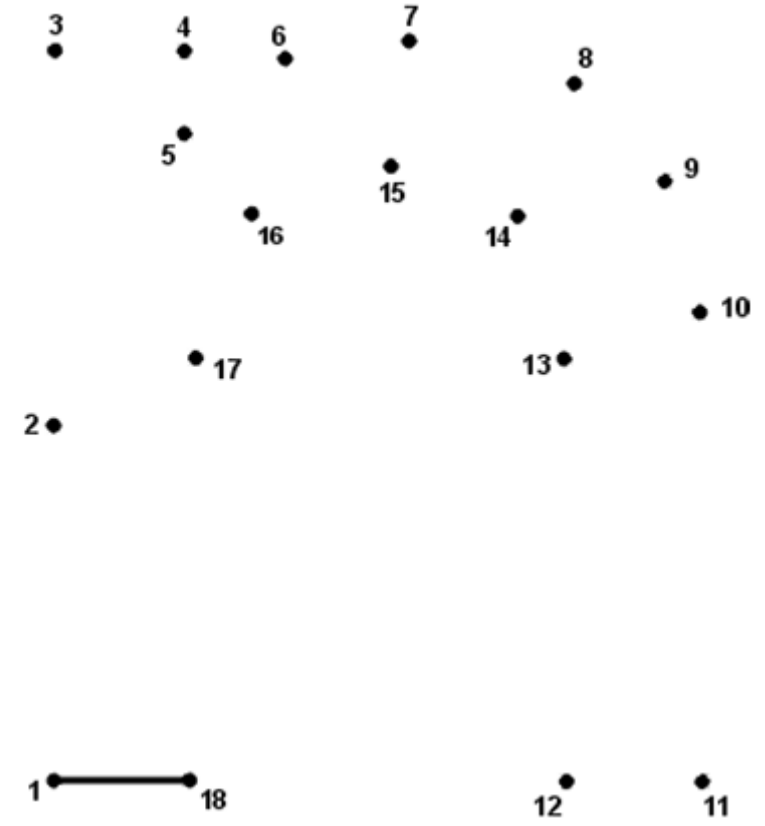
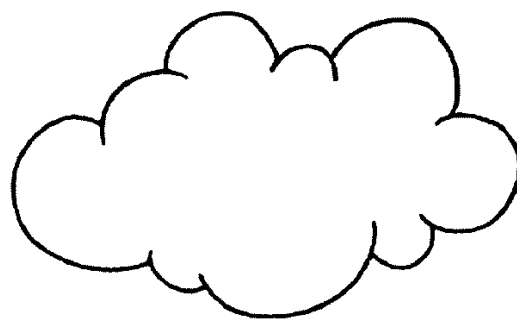

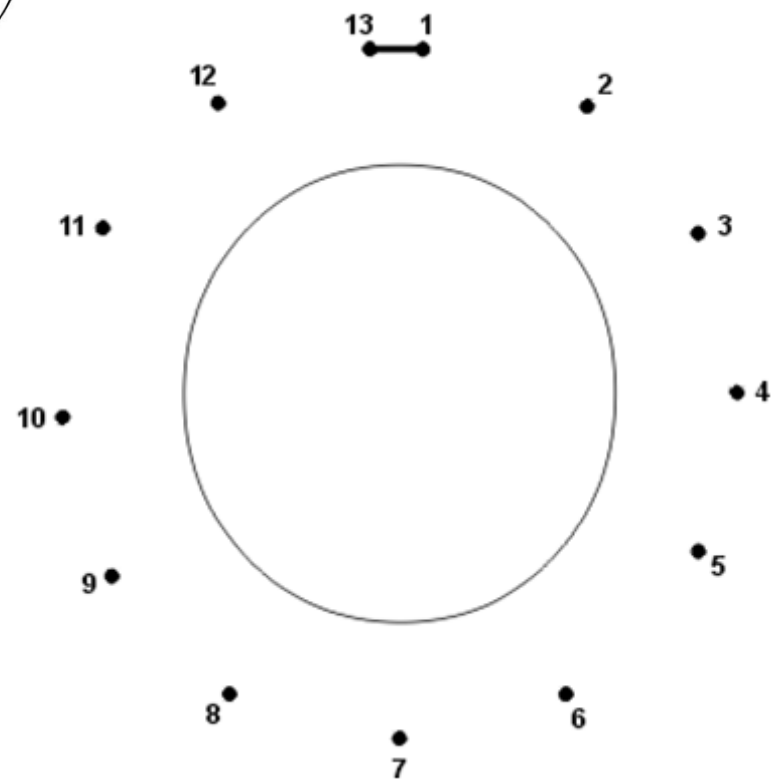
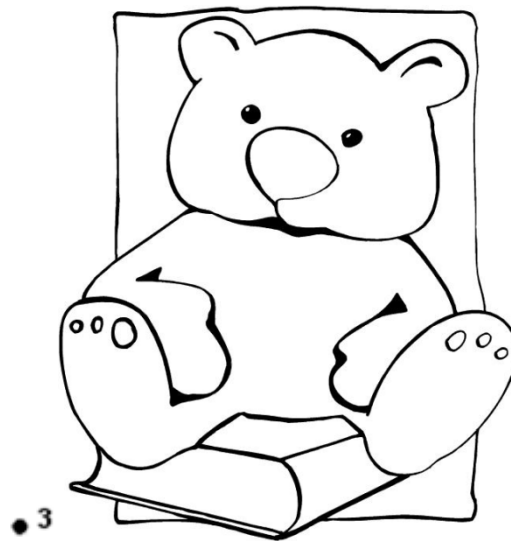
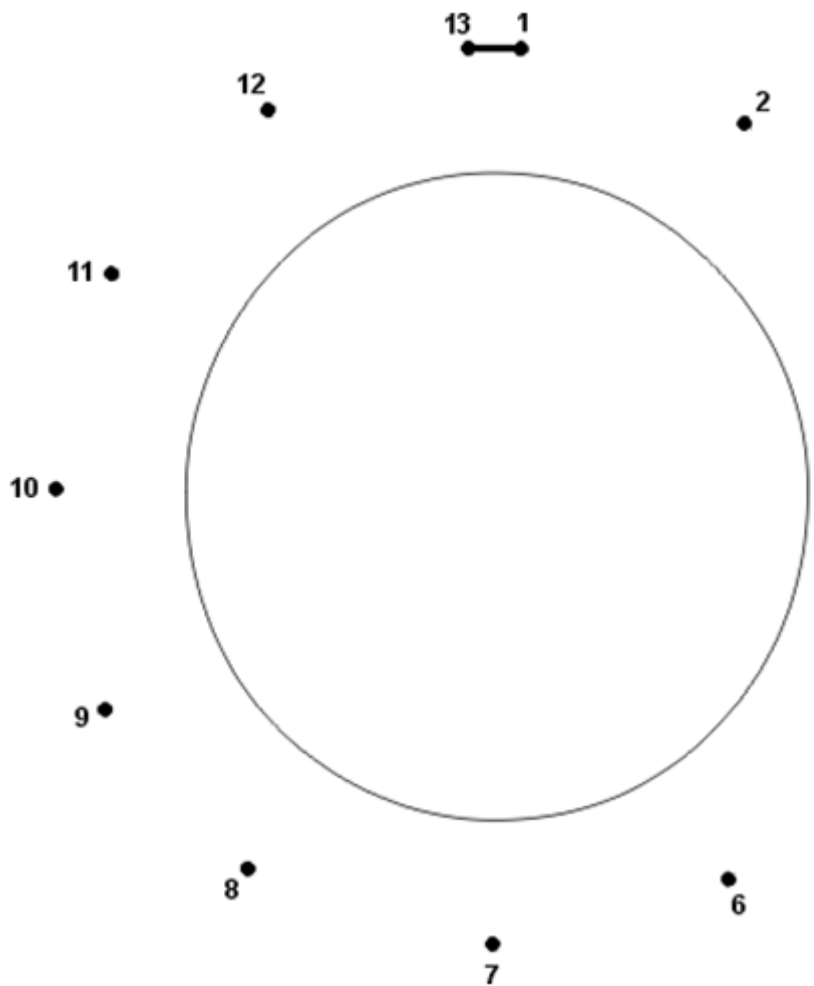

Maribel Martínez y Ginés Ciudad-Real

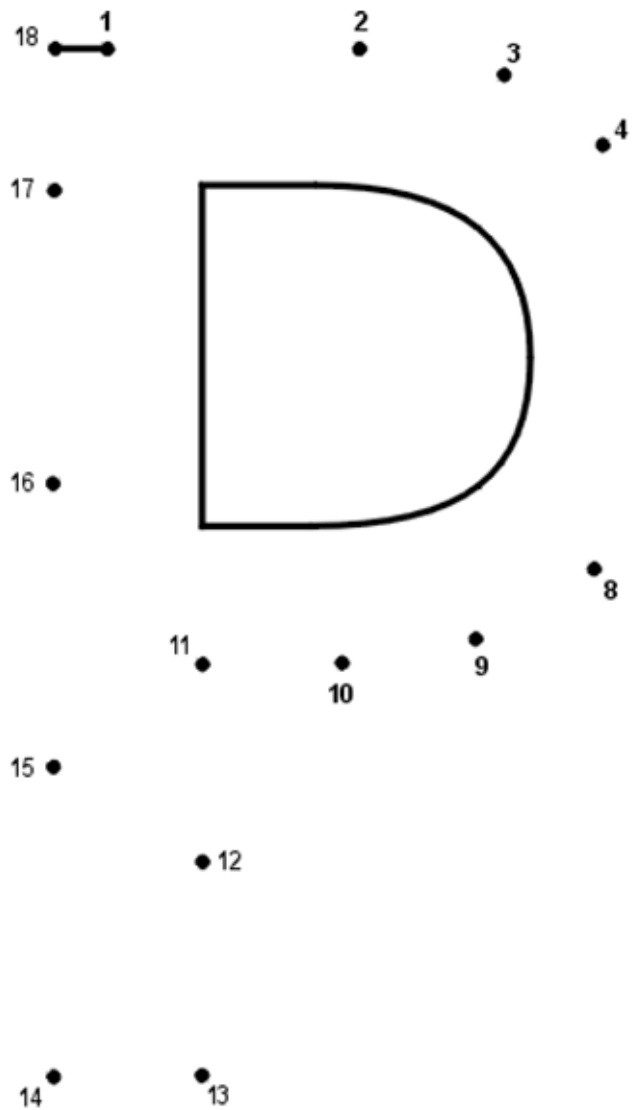

Fichas de grafomotricidad

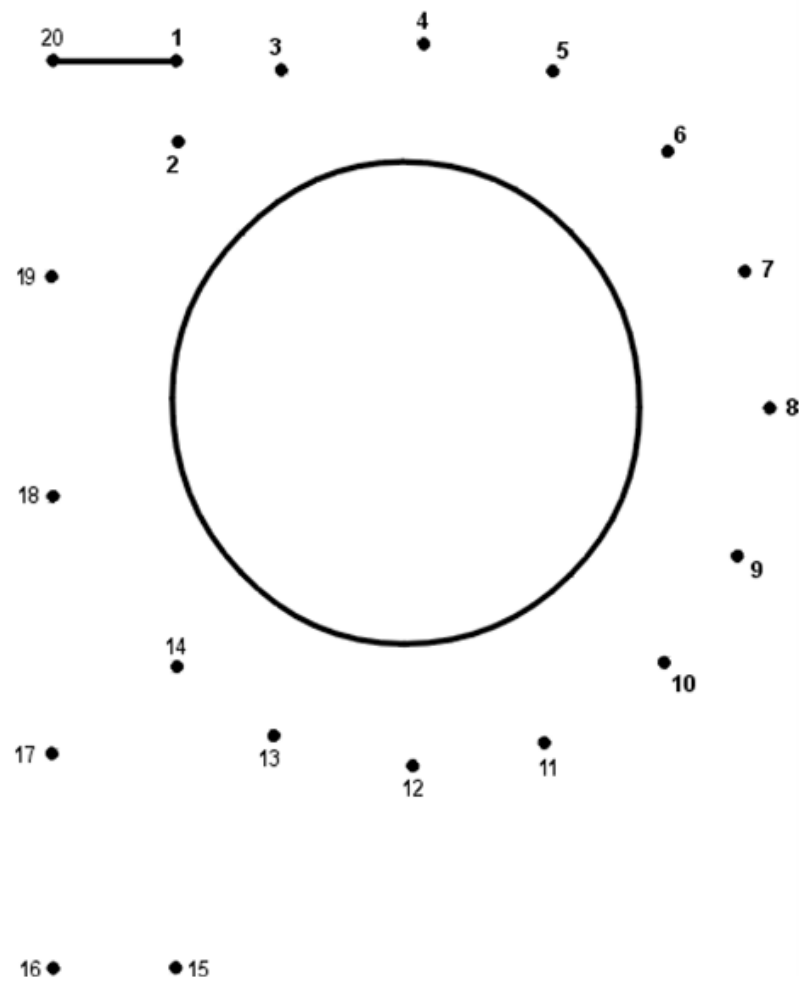

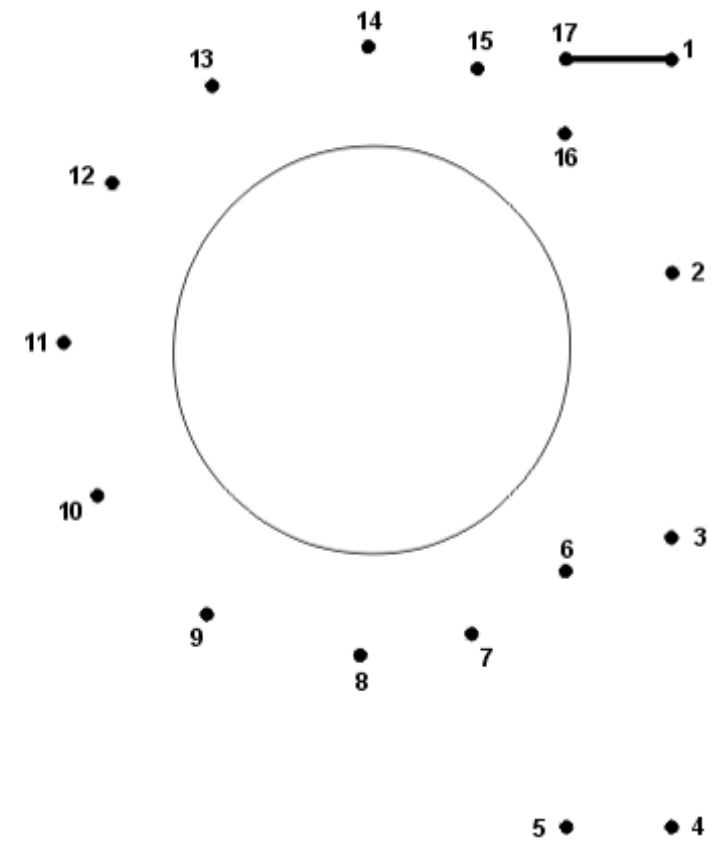
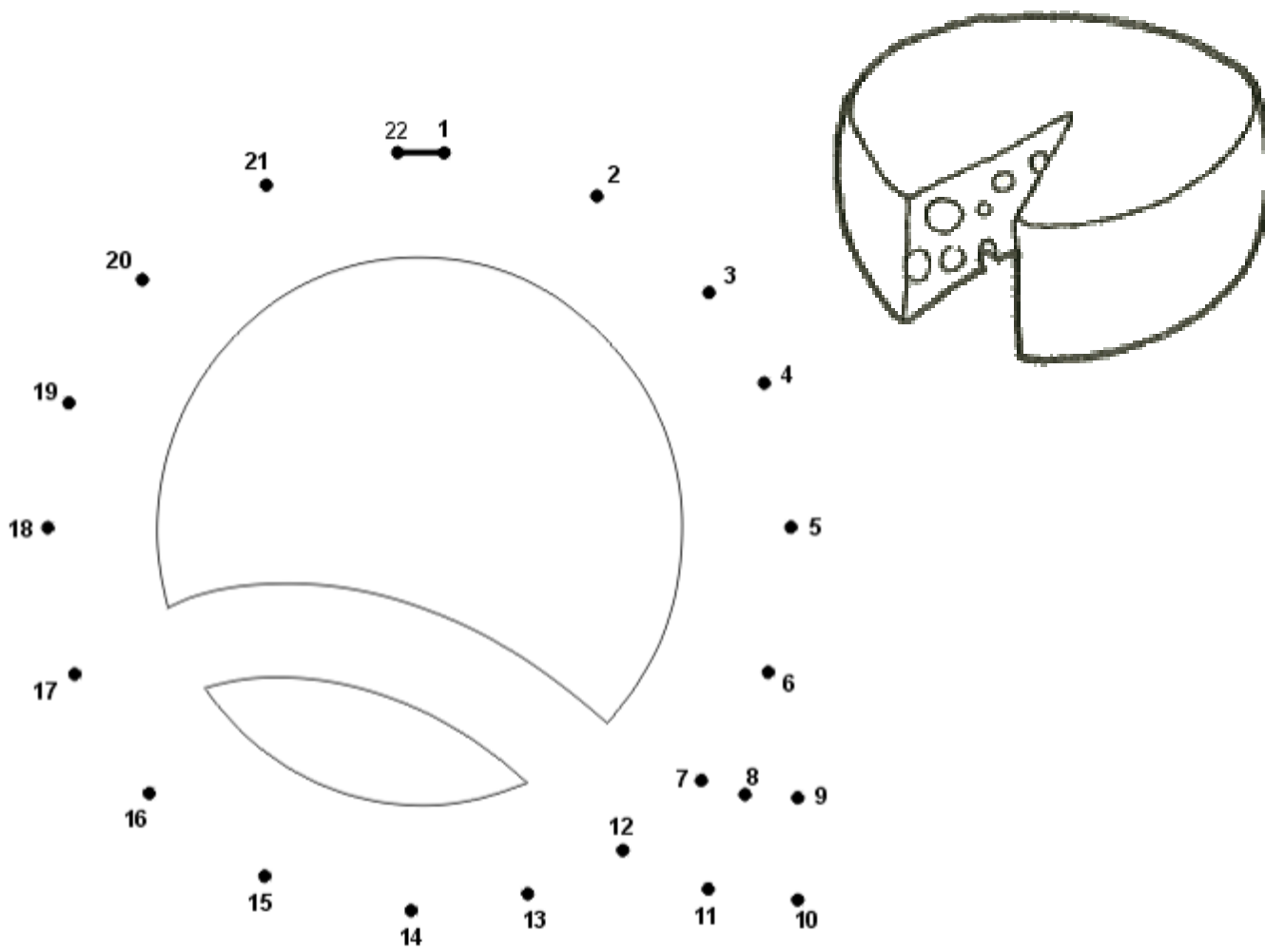

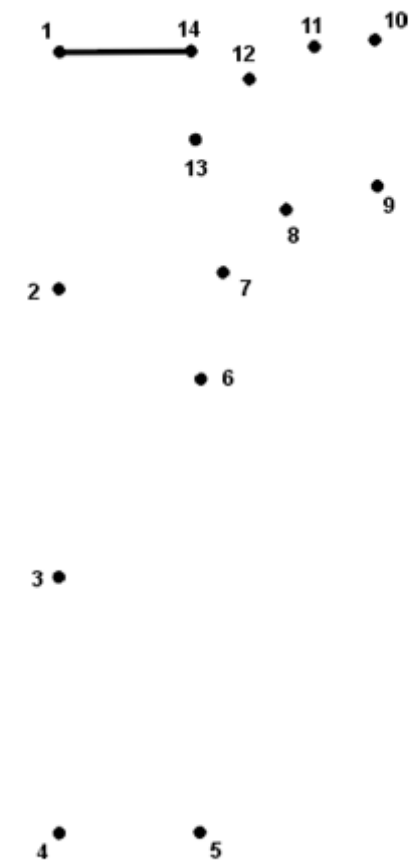
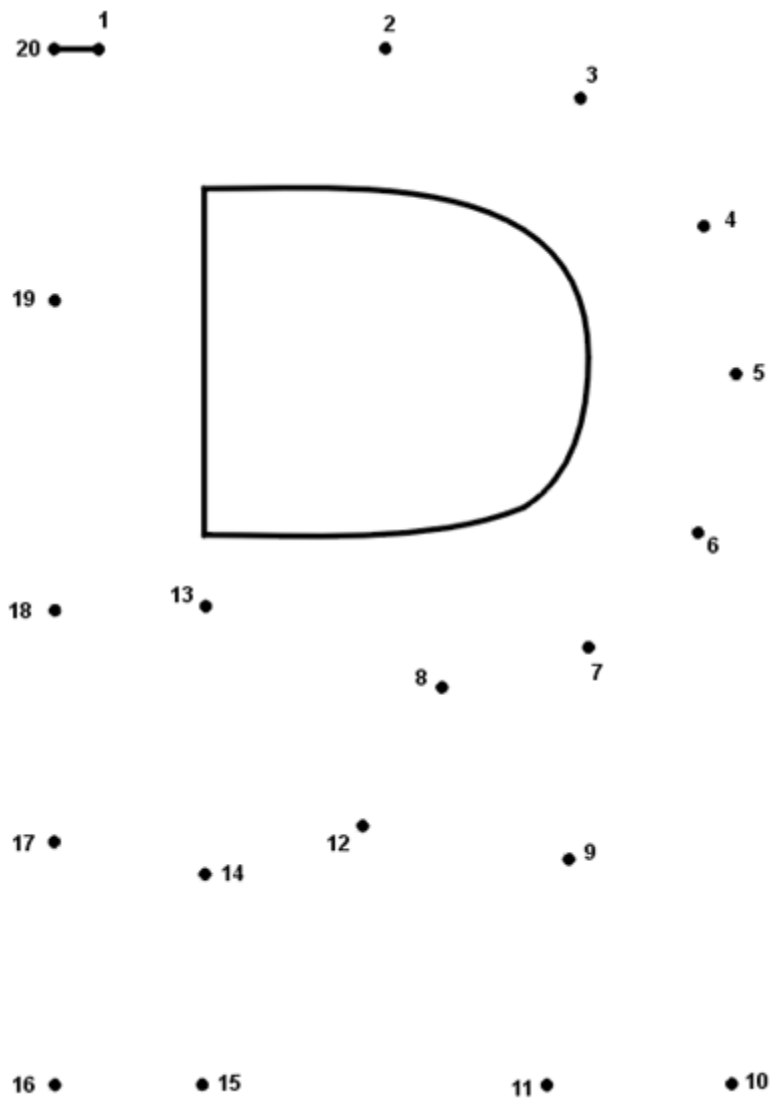

Maribel Martínez y Ginés Ciudad-Real

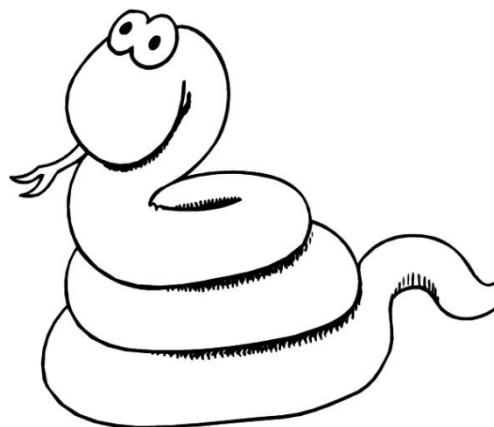

Fichas de grafomotricidad

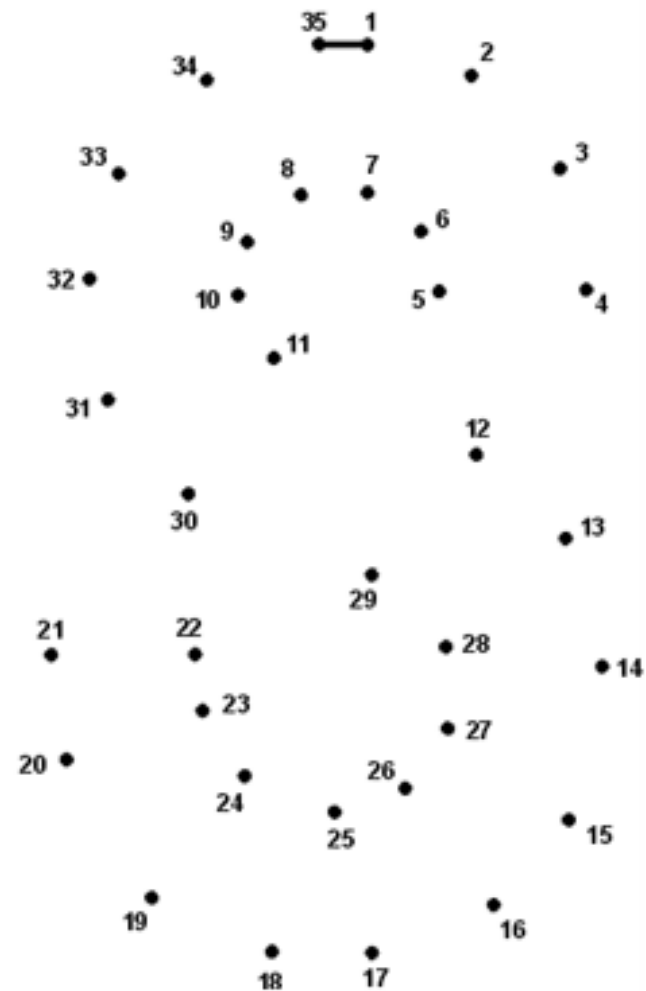

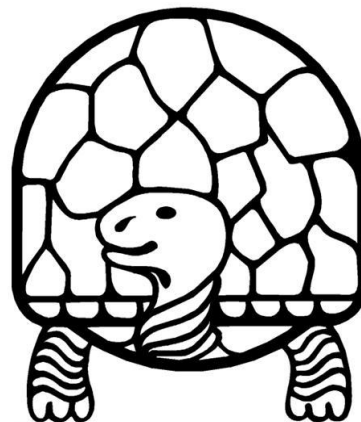

17 ————— 1

• 7 • 8

1 ————— 13

• 9 • 8

16 • • 2

• 6 • 9

2 •

• 7

15 •

• 3

5 •

• 10

• 12

10 •

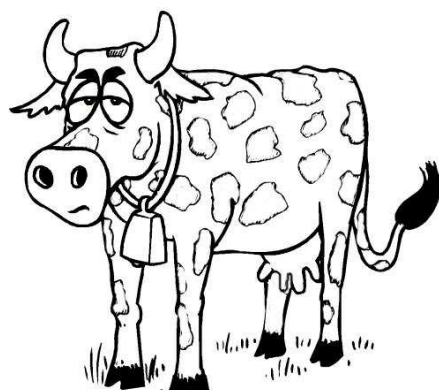

14 •

• 4

• 11

3 •

• 11

• 6

13 •

• 12

4 •

• 5

21 — 1

5 • • 6

10 • • 11

1 — 19

15 • • 14

10 • • 9

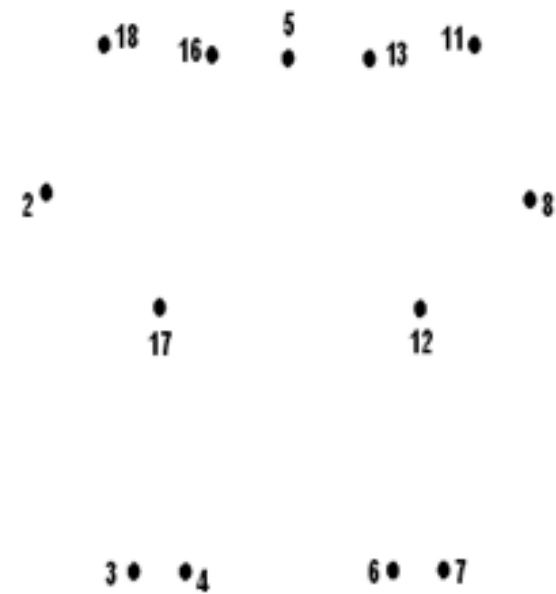

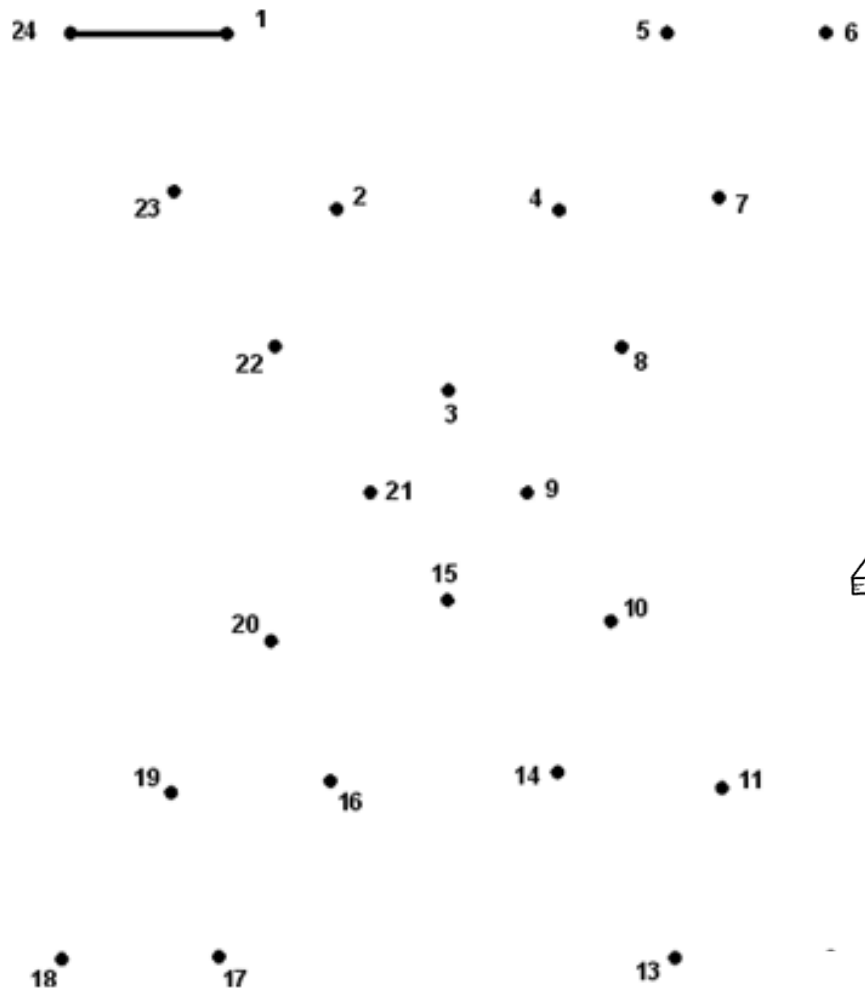

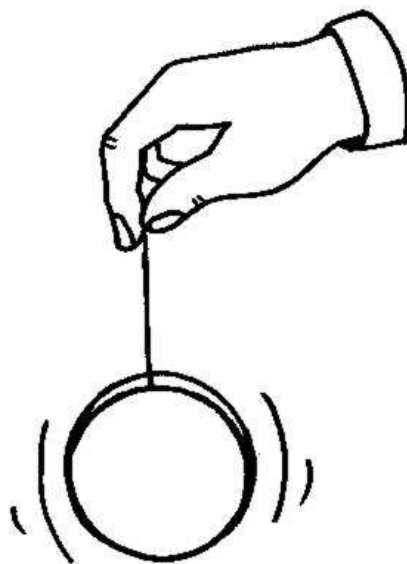
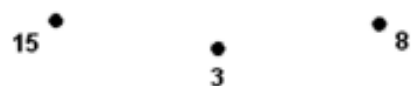

Maribel Martínez y Ginés Ciudad-Real

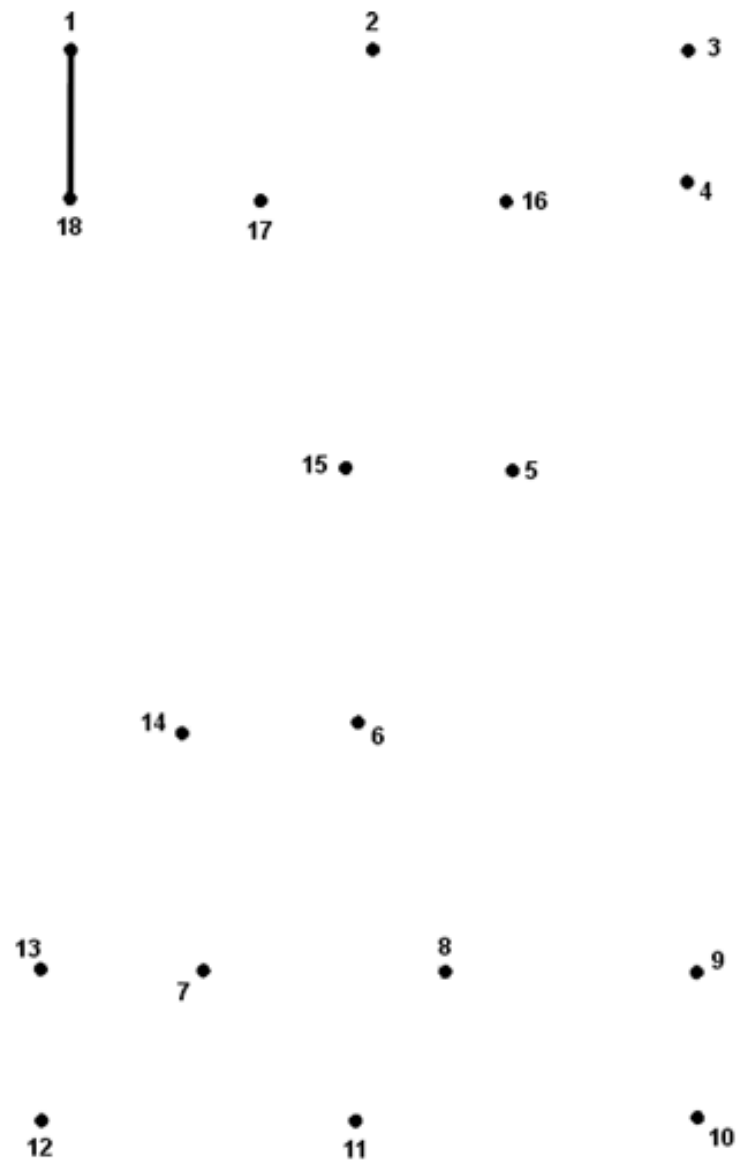

Fichas de grafomotricidad



Actividades para mejorar la psicomotricidad

Sigue las estrellitas para ir desde el sol a la tierra

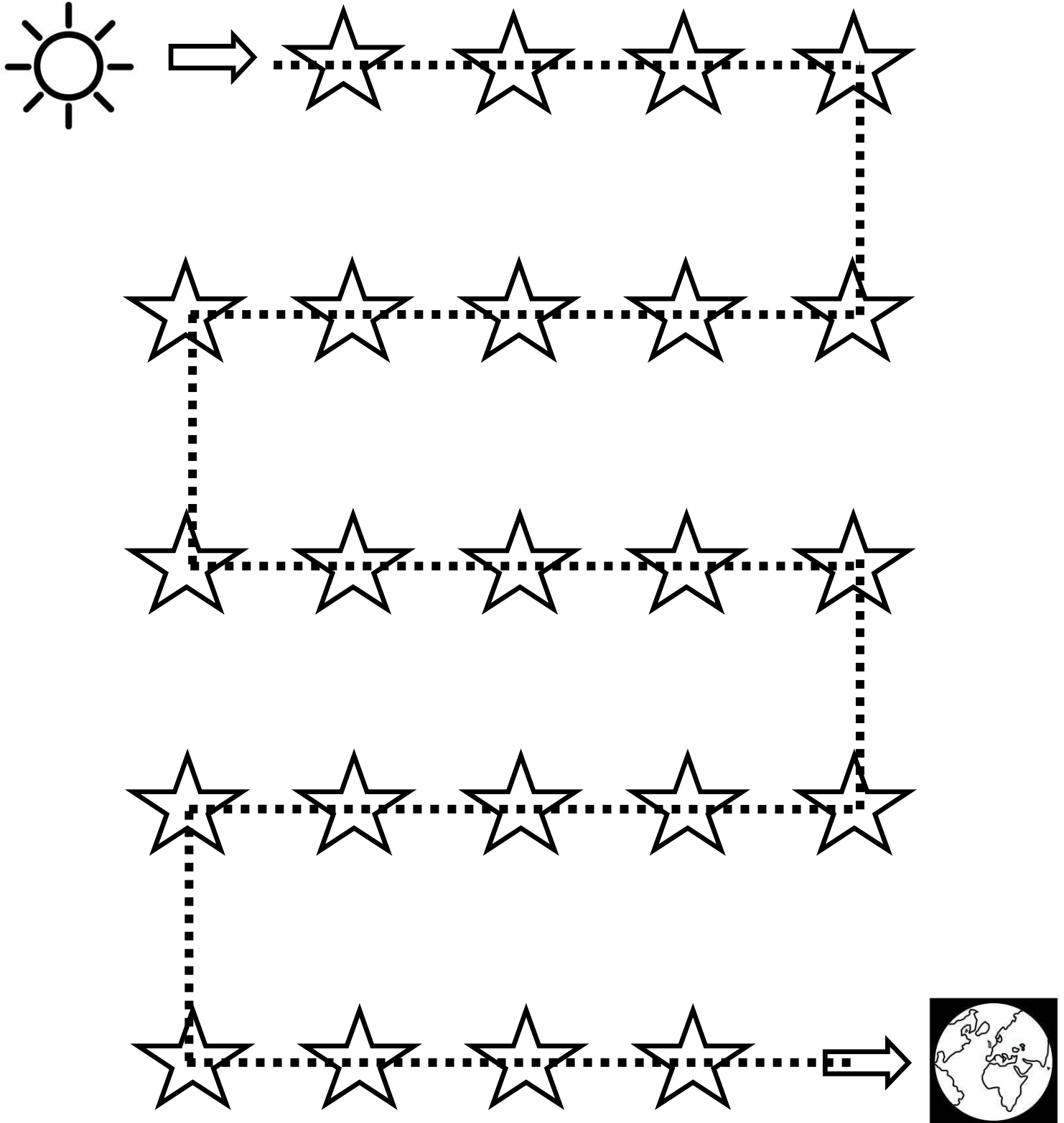

Actividades para mejorar la psicomotricidad

Sigue las estrellitas para ir desde el sol a la tierra

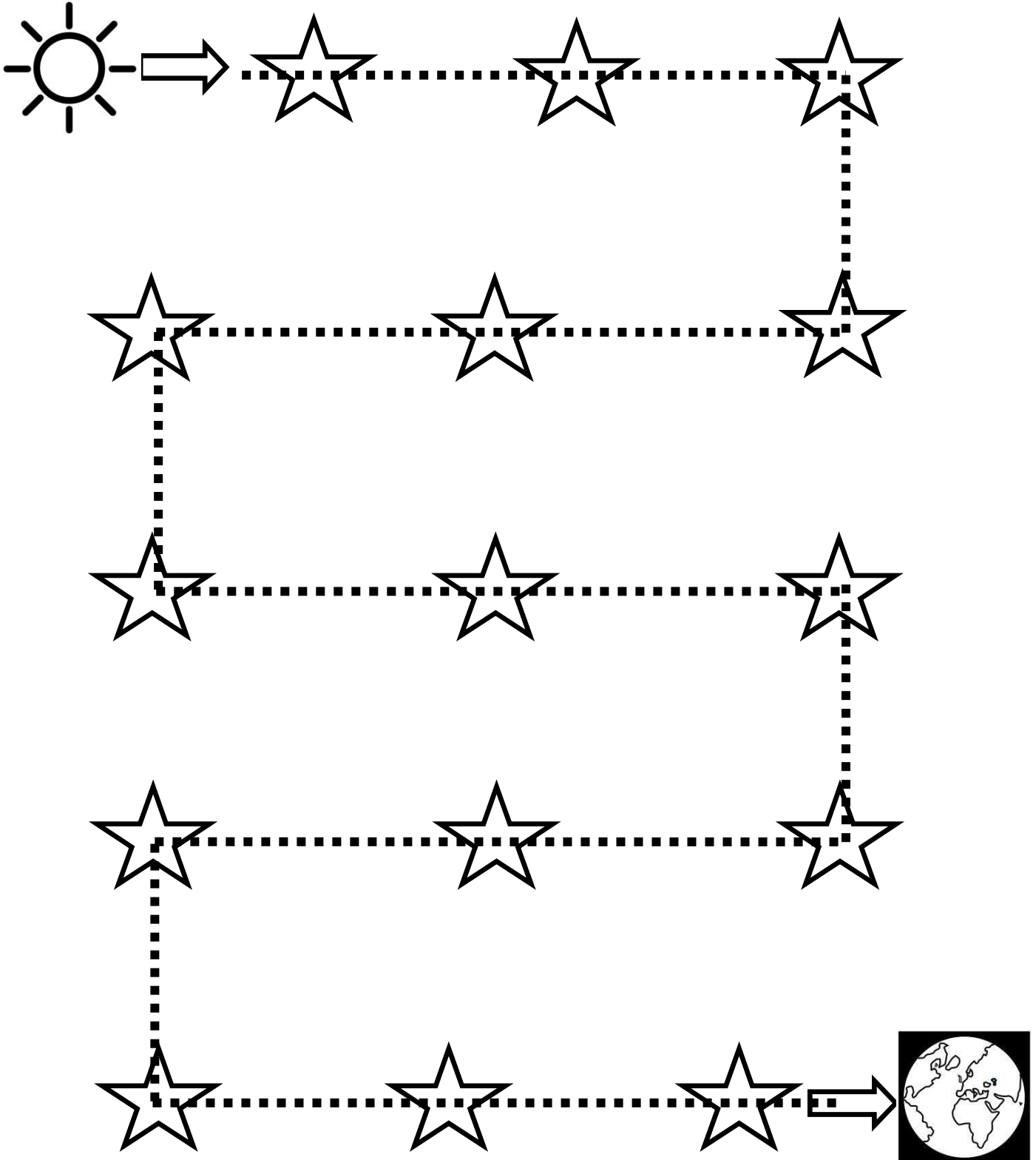

Actividades para mejorar la psicomotricidad

Sigue las estrellitas para ir desde el sol a la tierra

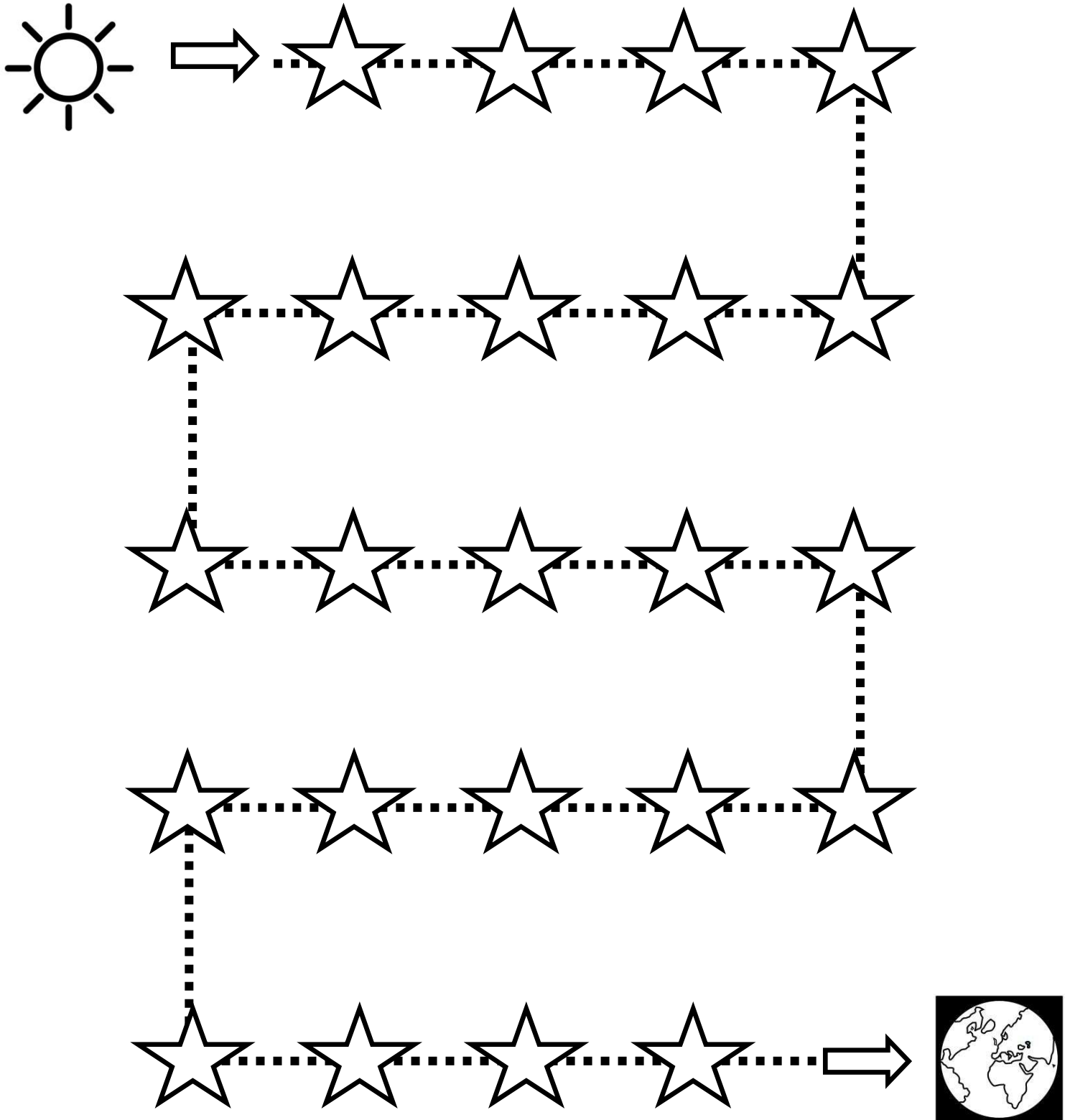

Actividades para mejorar la psicomotricidad

Sigue las estrellitas para ir desde el sol a la tierra

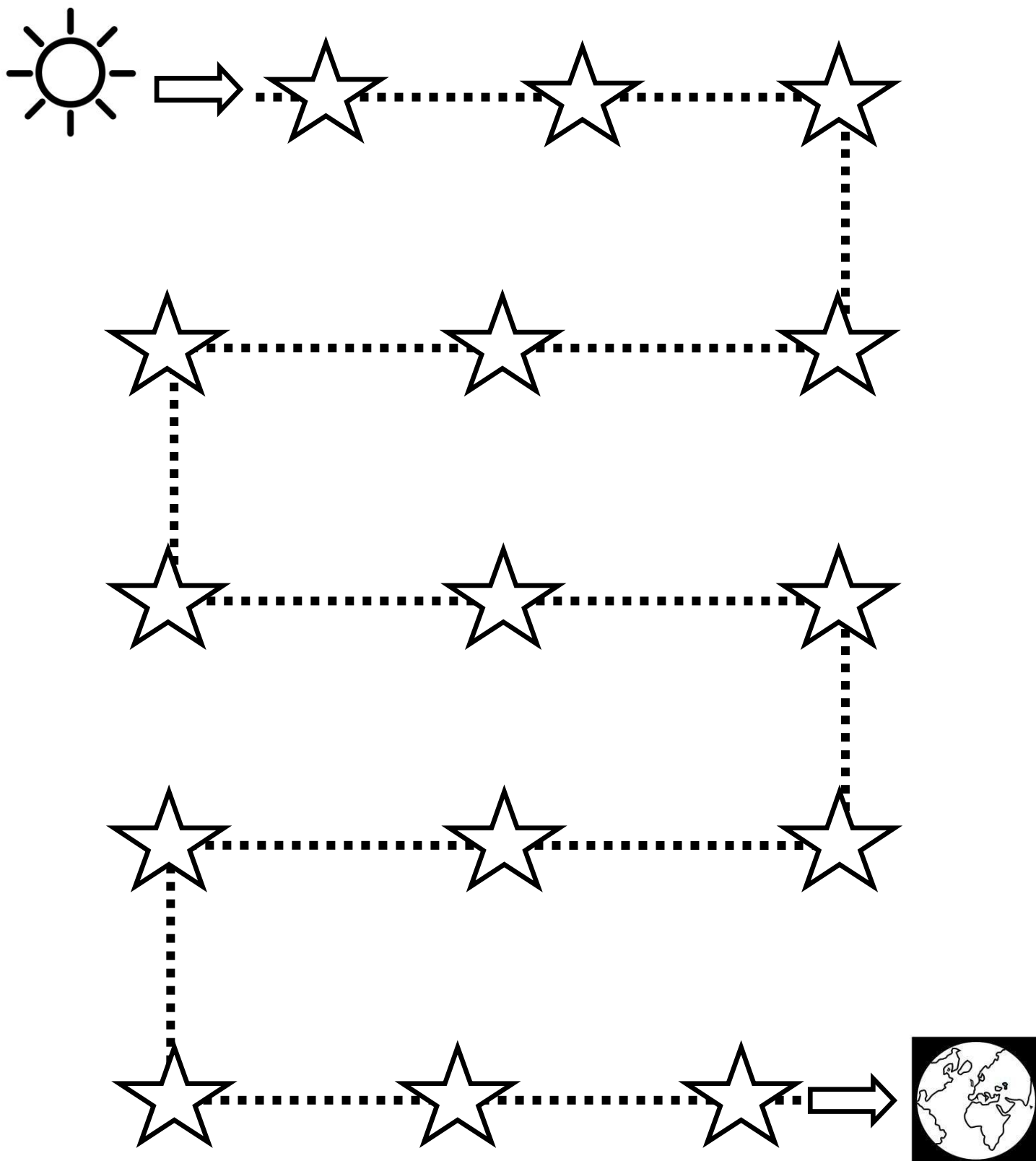

Actividades para mejorar la psicomotricidad

Sigue las estrellitas para ir desde el sol a la tierra

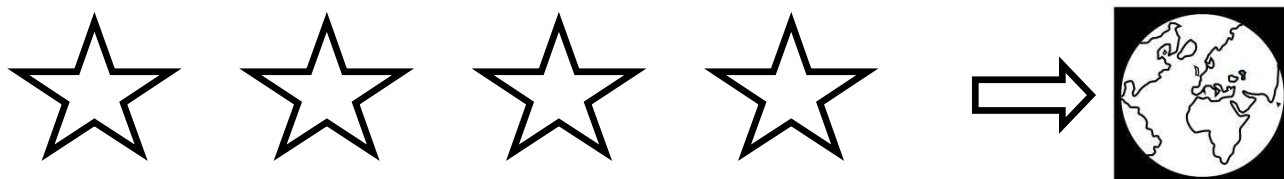
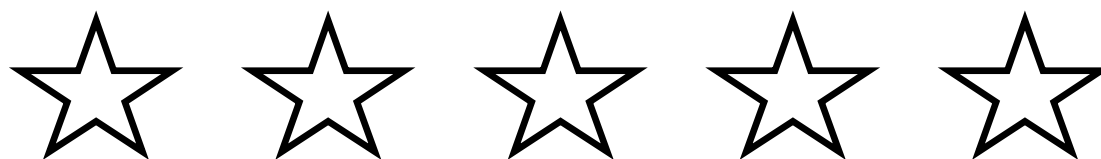
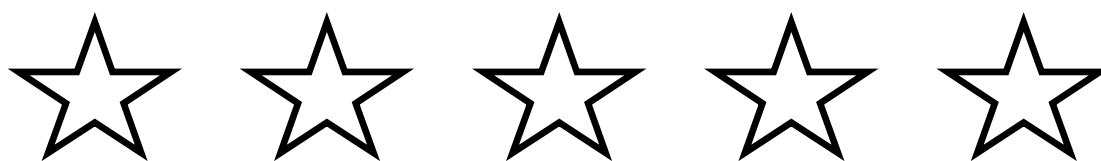
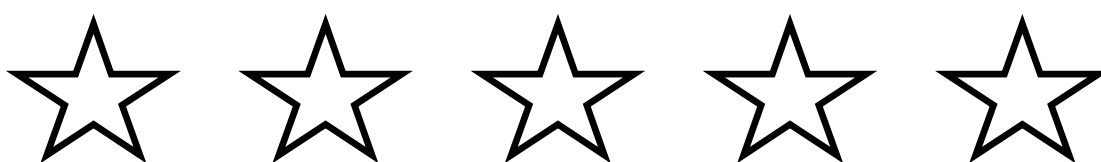
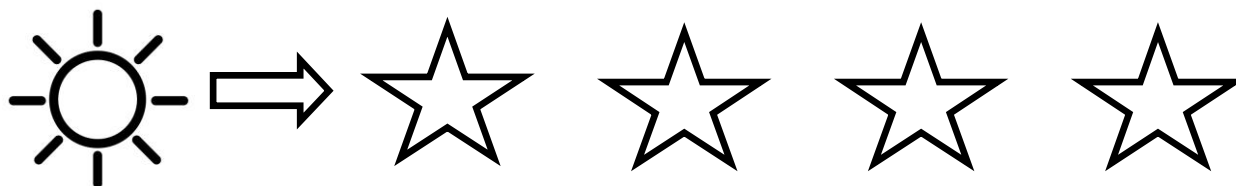

Actividades para mejorar la psicomotricidad

Sigue las estrellitas para ir desde el sol a la tierra

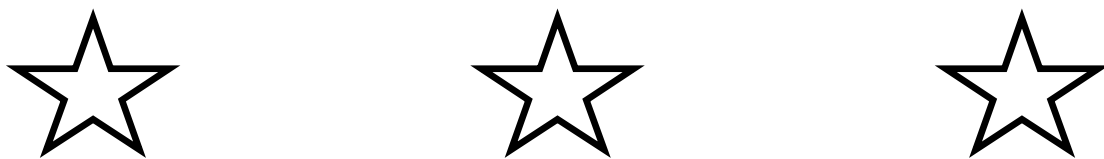
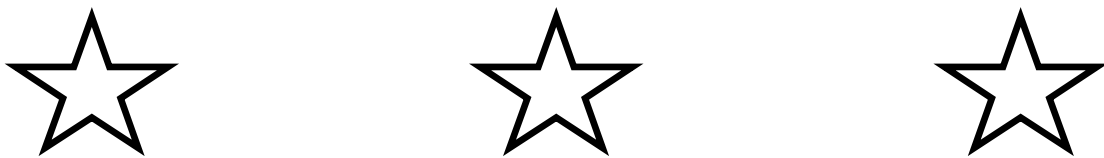
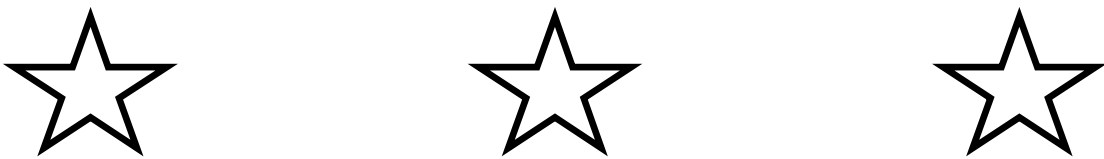

Actividades para mejorar la psicomotricidad

Sigue los huevos para unir la gallina y el pollito

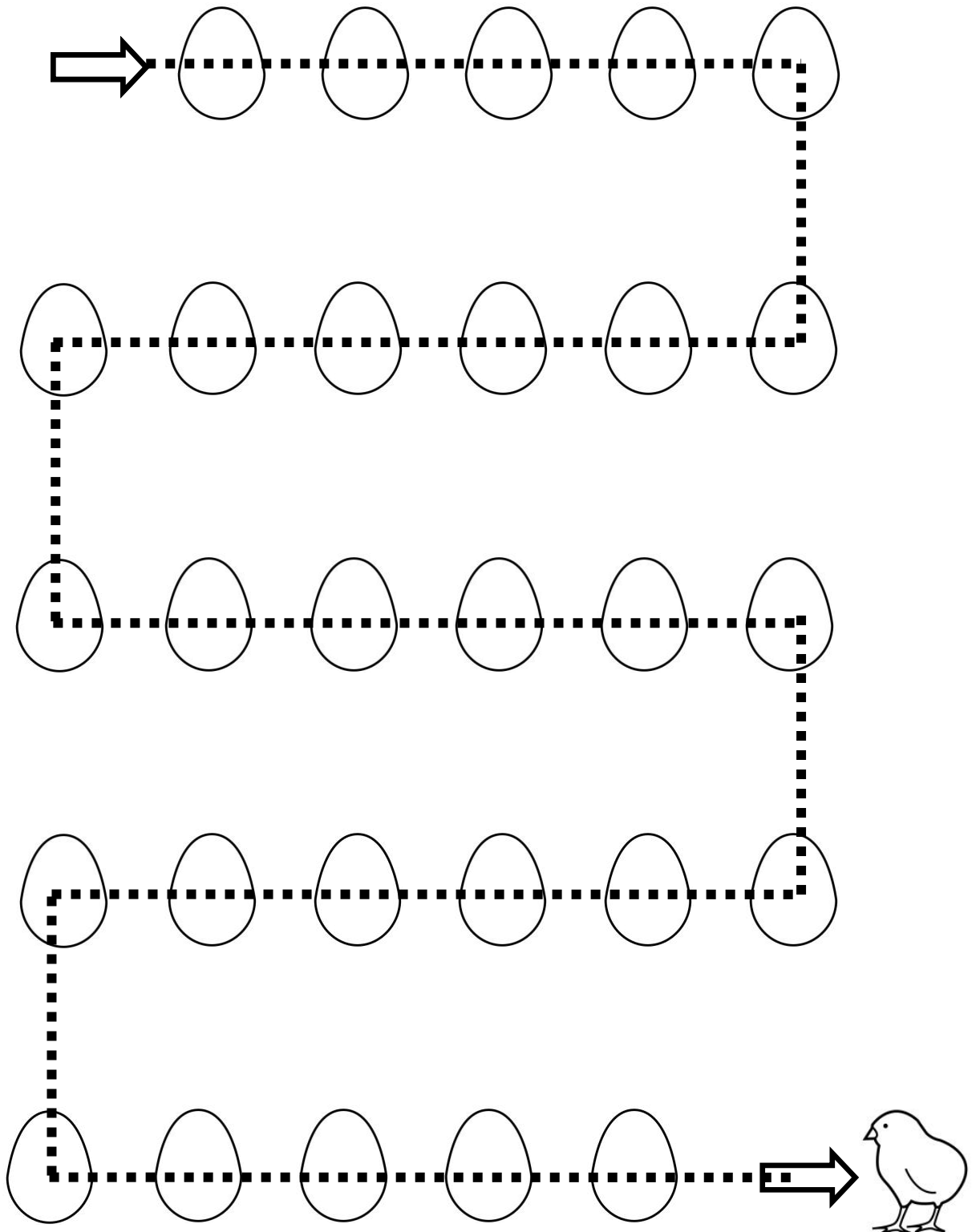
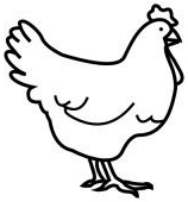

Actividades para mejorar la psicomotricidad

Sigue los huevos para unir la gallina y el pollito

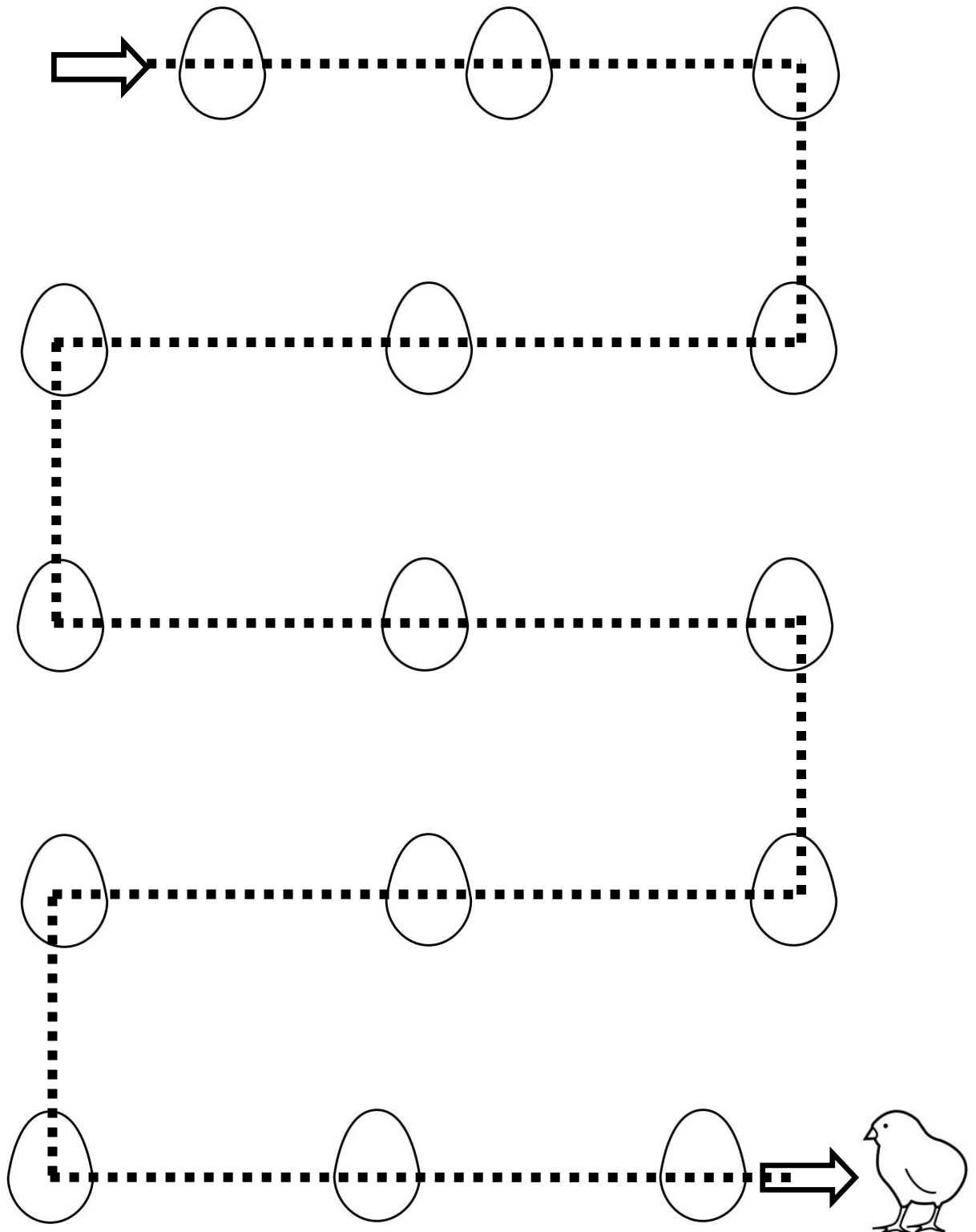
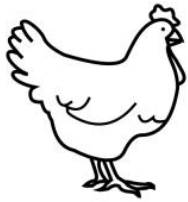

Actividades para mejorar la psicomotricidad

Sigue los huevos para unir la gallina y el pollito

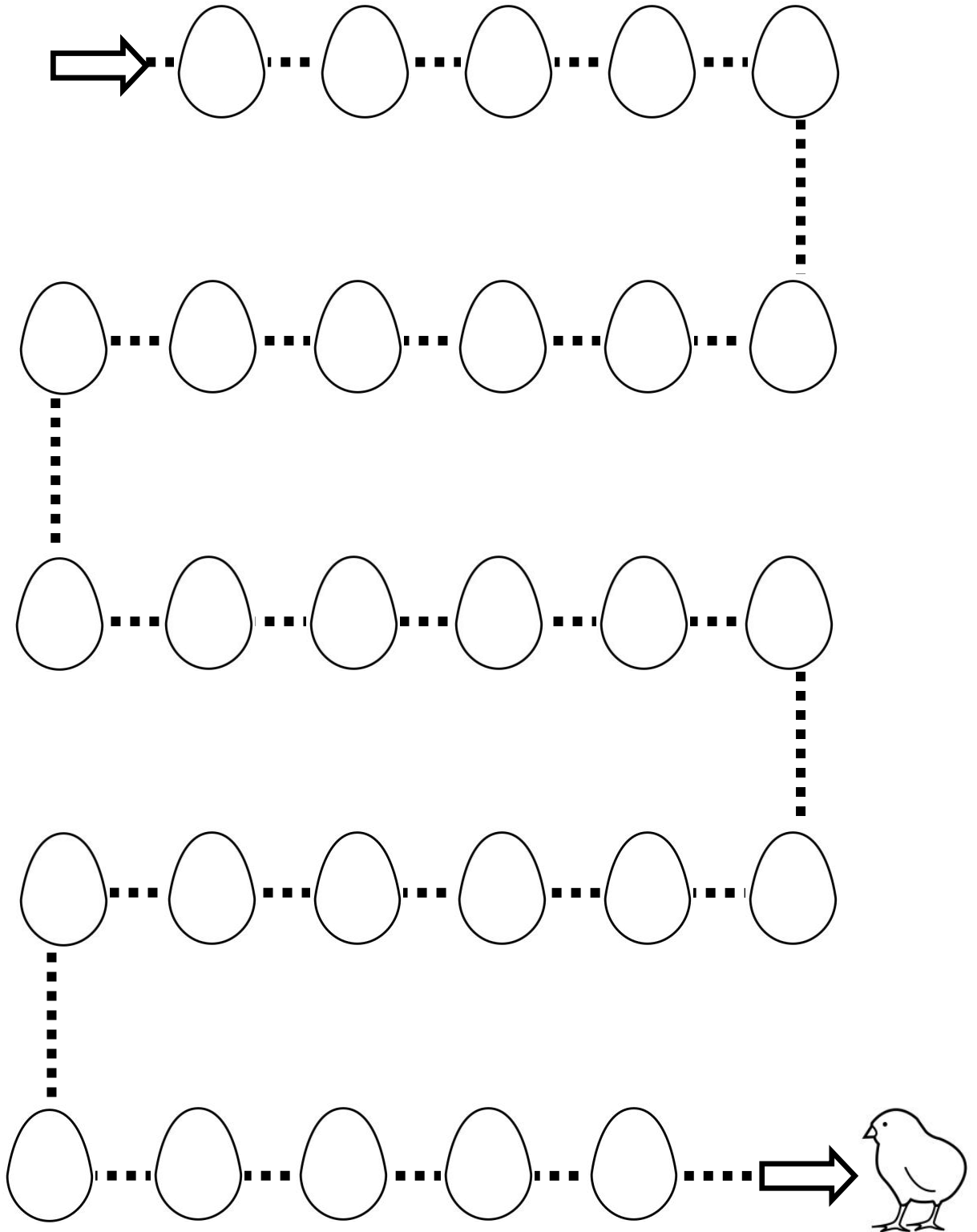
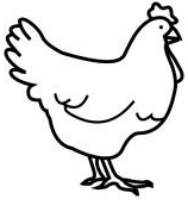

Actividades para mejorar la psicomotricidad

Sigue los huevos para unir la gallina y el pollito

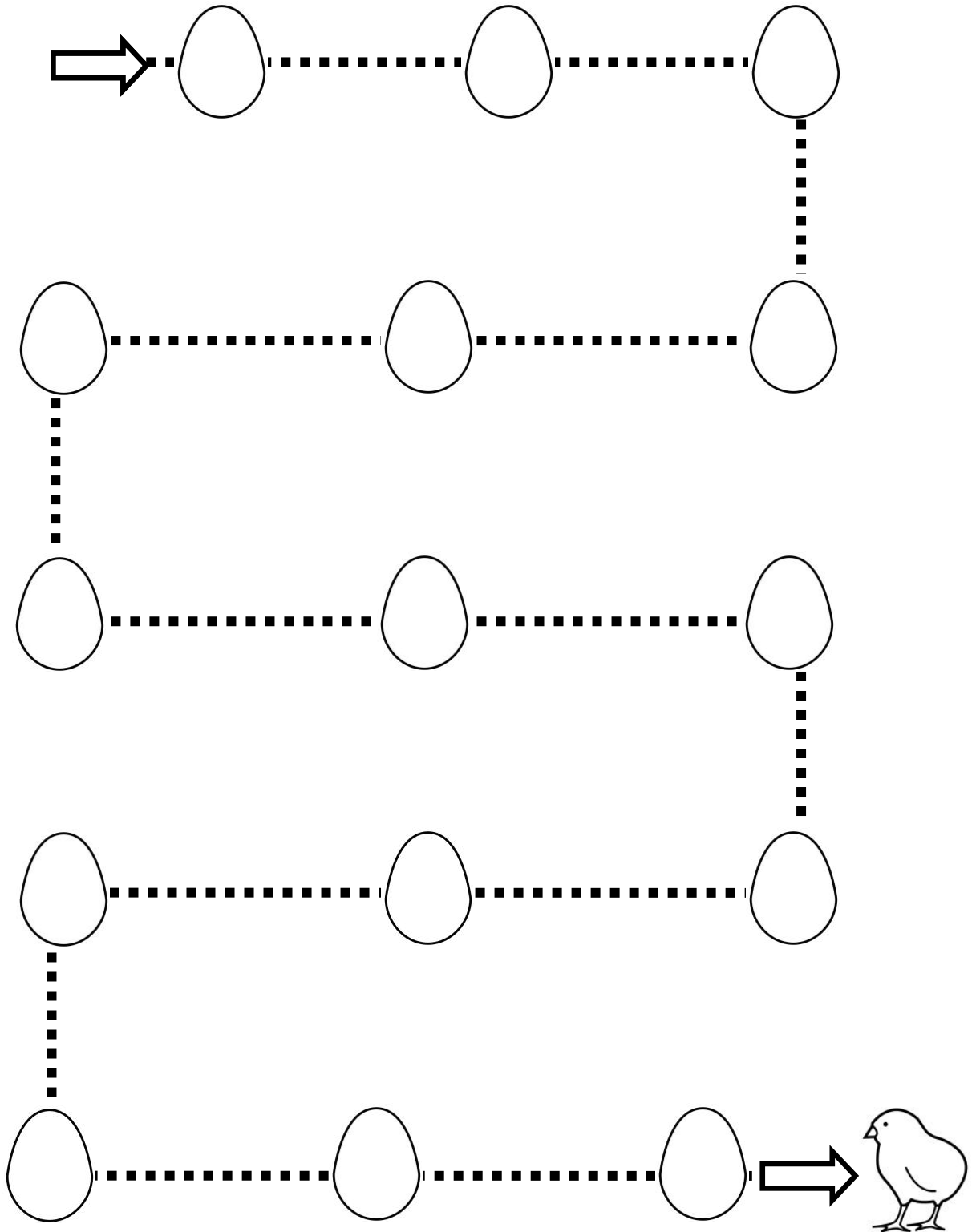
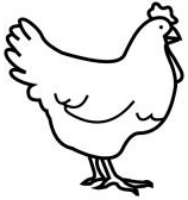

Actividades para mejorar la psicomotricidad

Sigue los huevos para unir la gallina y el pollito

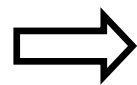
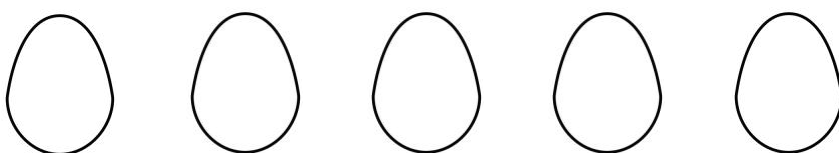
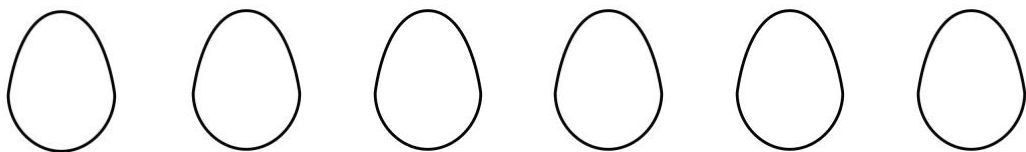
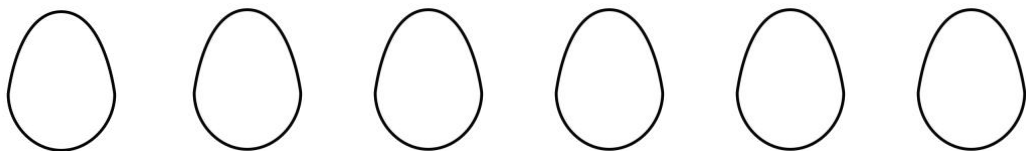
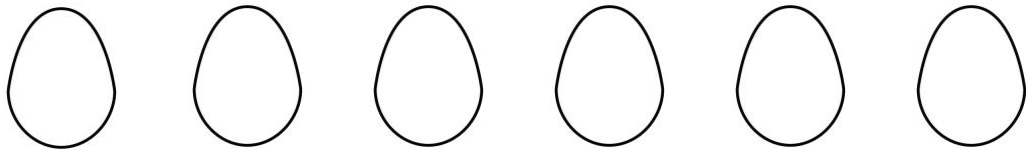
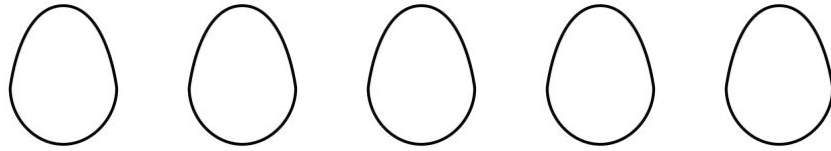
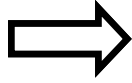
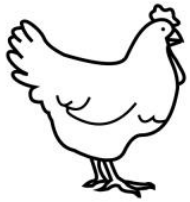

Actividades para mejorar la psicomotricidad

Sigue los huevos para unir la gallina y el pollito

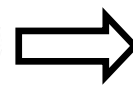
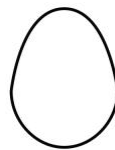
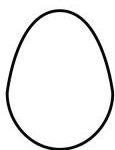
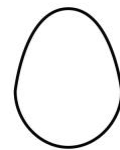
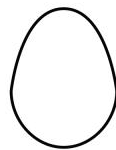
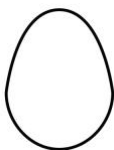
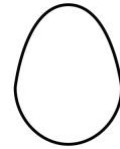
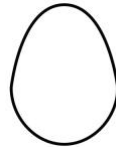
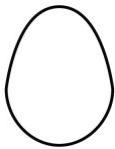
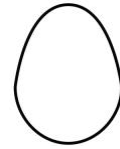
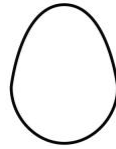
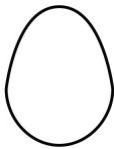
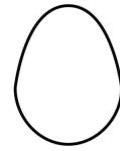
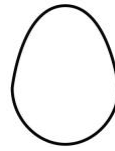
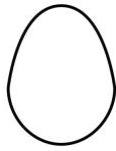
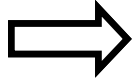
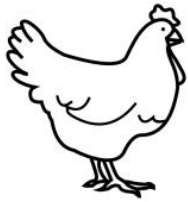

Actividades para mejorar la psicomotricidad

Sigue los corazones para unir a la mama y a su bebe

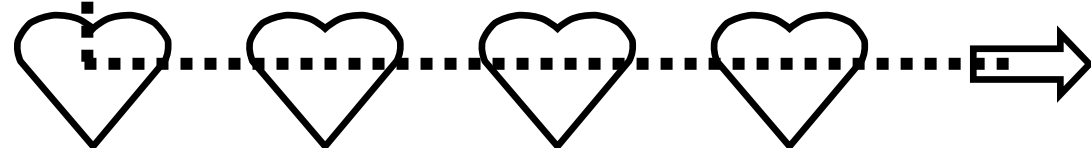
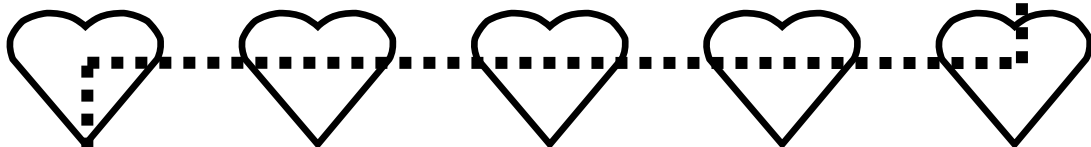
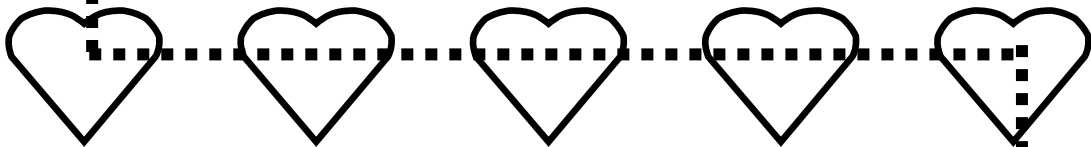
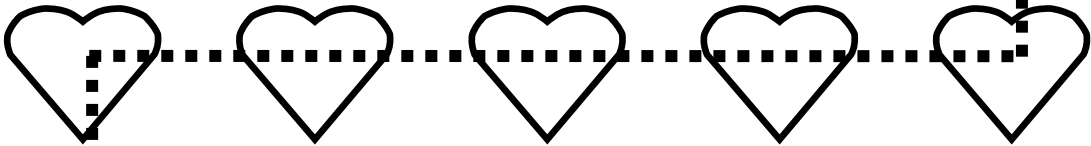
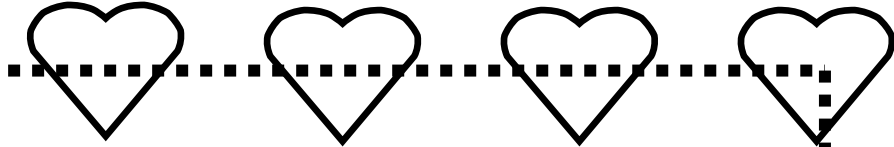
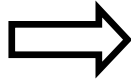

Actividades para mejorar la psicomotricidad

Sigue los corazones para unir a la mama y a su bebe

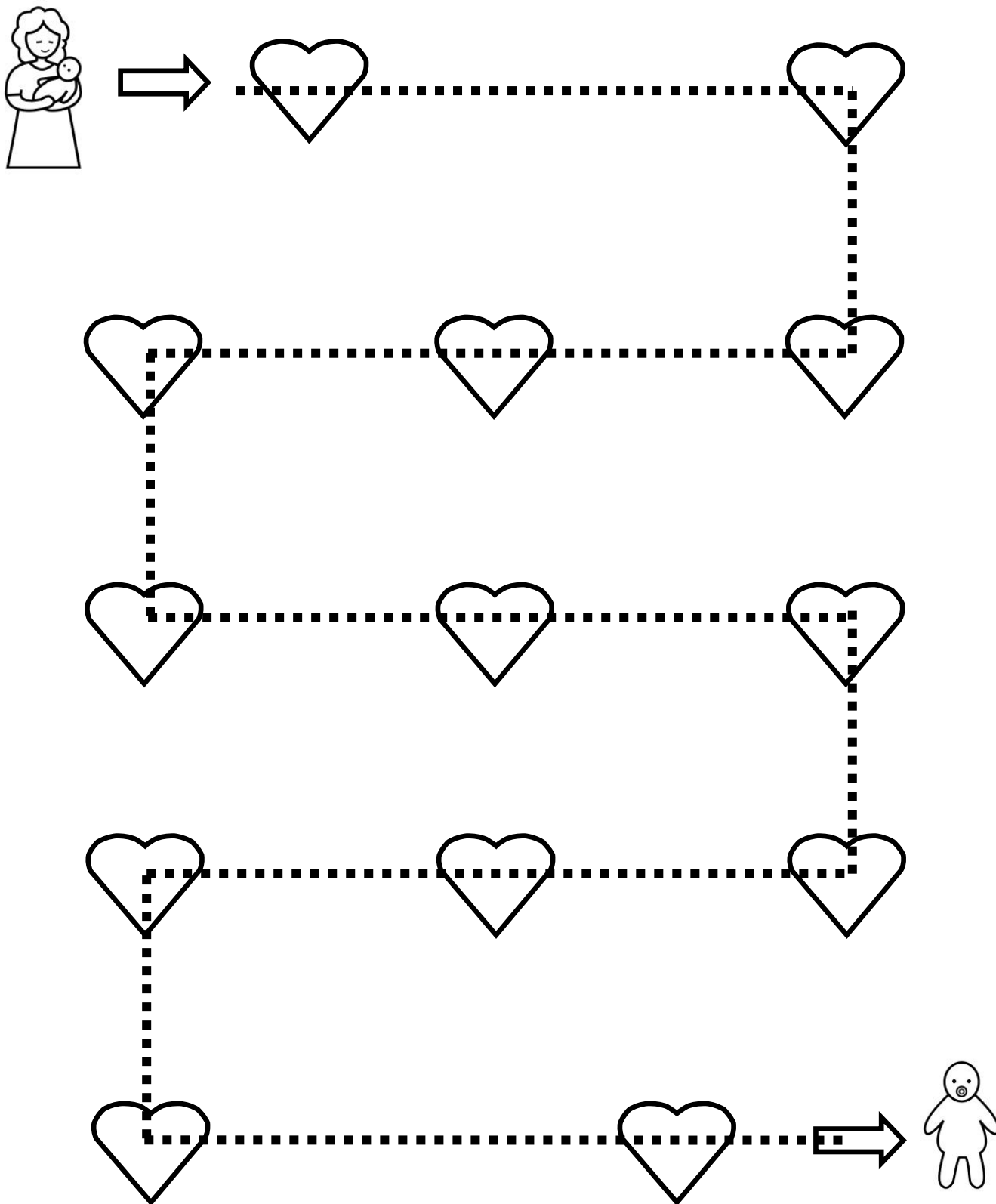

Actividades para mejorar la psicomotricidad

Sigue los corazones para unir a la mama y a su bebe

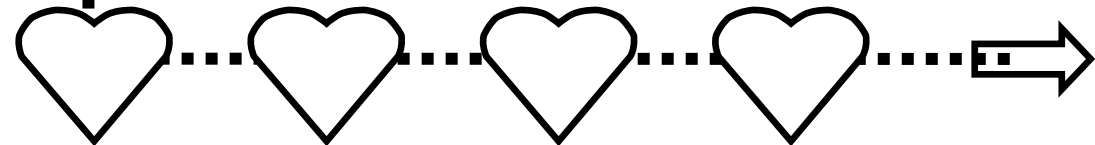
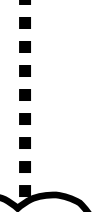
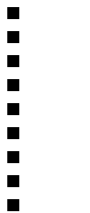
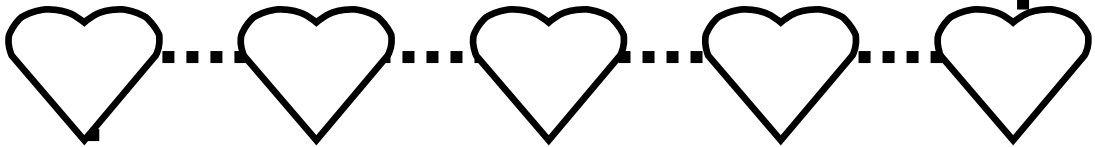
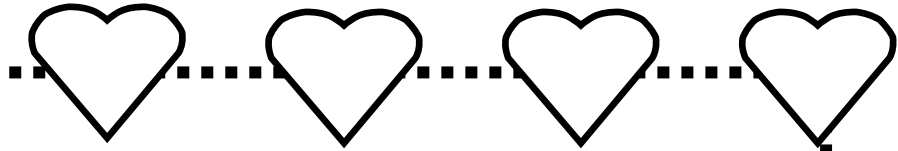

Actividades para mejorar la psicomotricidad

Sigue los corazones para unir a la mama y a su bebe

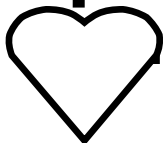
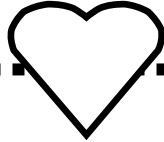
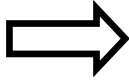

Actividades para mejorar la psicomotricidad

Sigue los corazones para unir a la mama y a su bebe

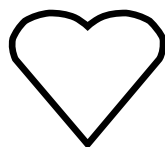
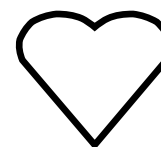
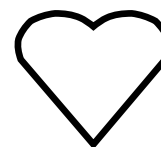
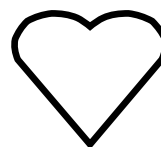
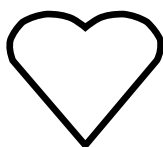
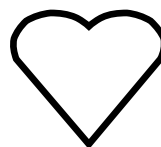
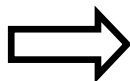

Actividades para mejorar la psicomotricidad

Sigue los corazones para unir a la mama y a su bebe

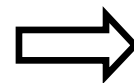
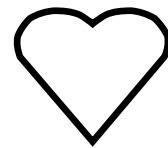
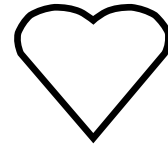

Actividades para mejorar la psicomotricidad

Sigue las caras para unir al niño y a la niña

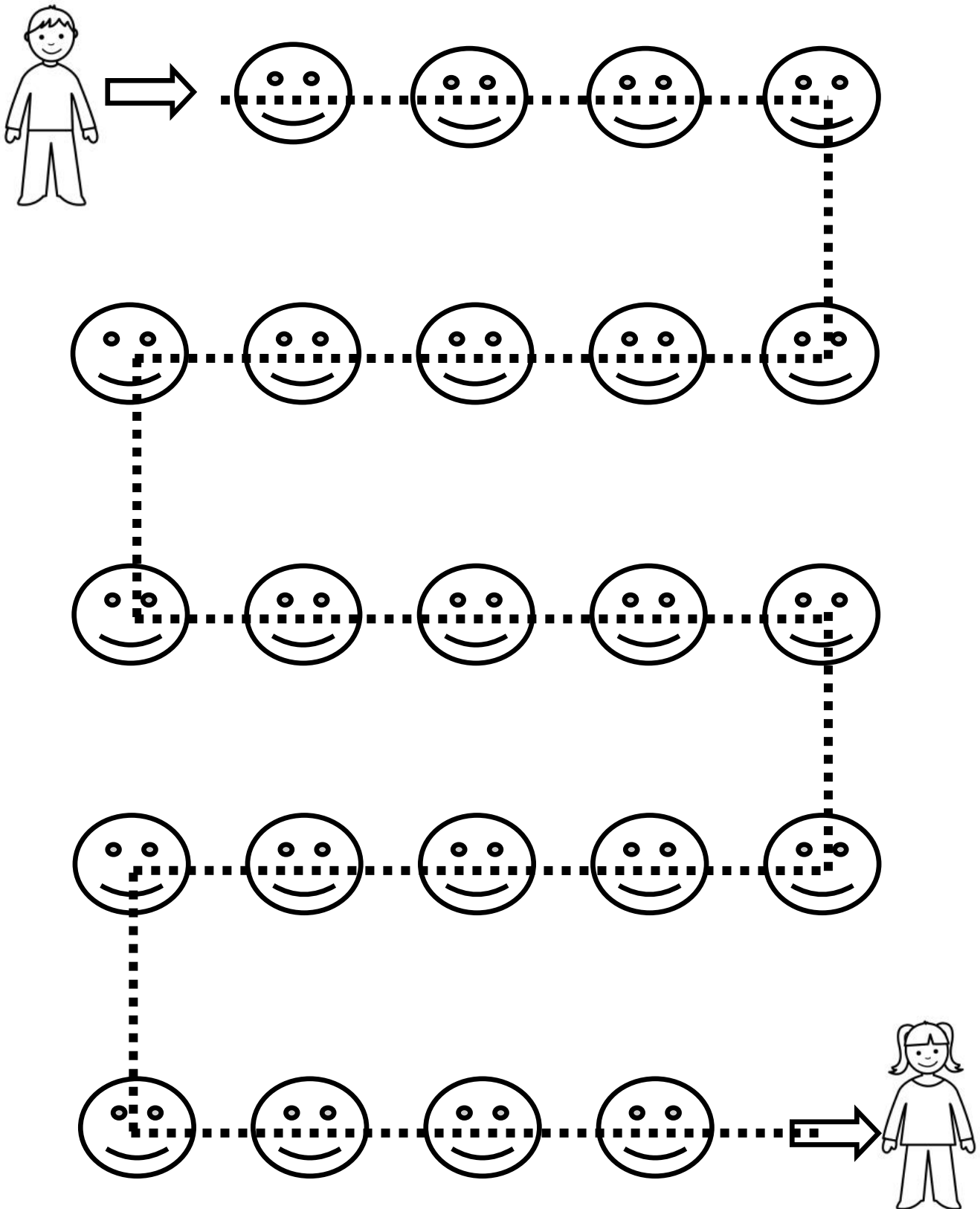

Actividades para mejorar la psicomotricidad

Sigue las caras para unir al niño y a la niña

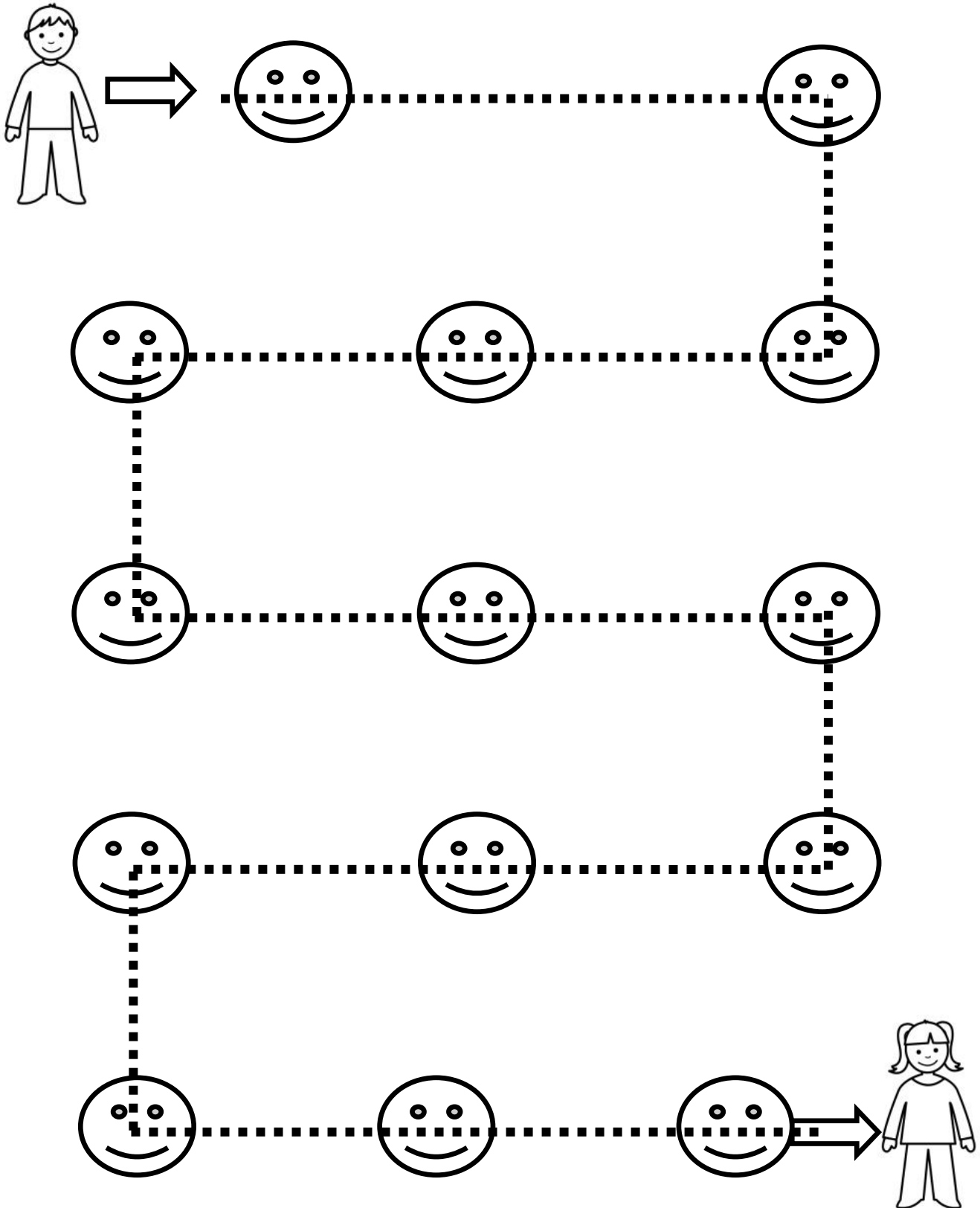

Actividades para mejorar la psicomotricidad

Sigue las caras para unir al niño y a la niña

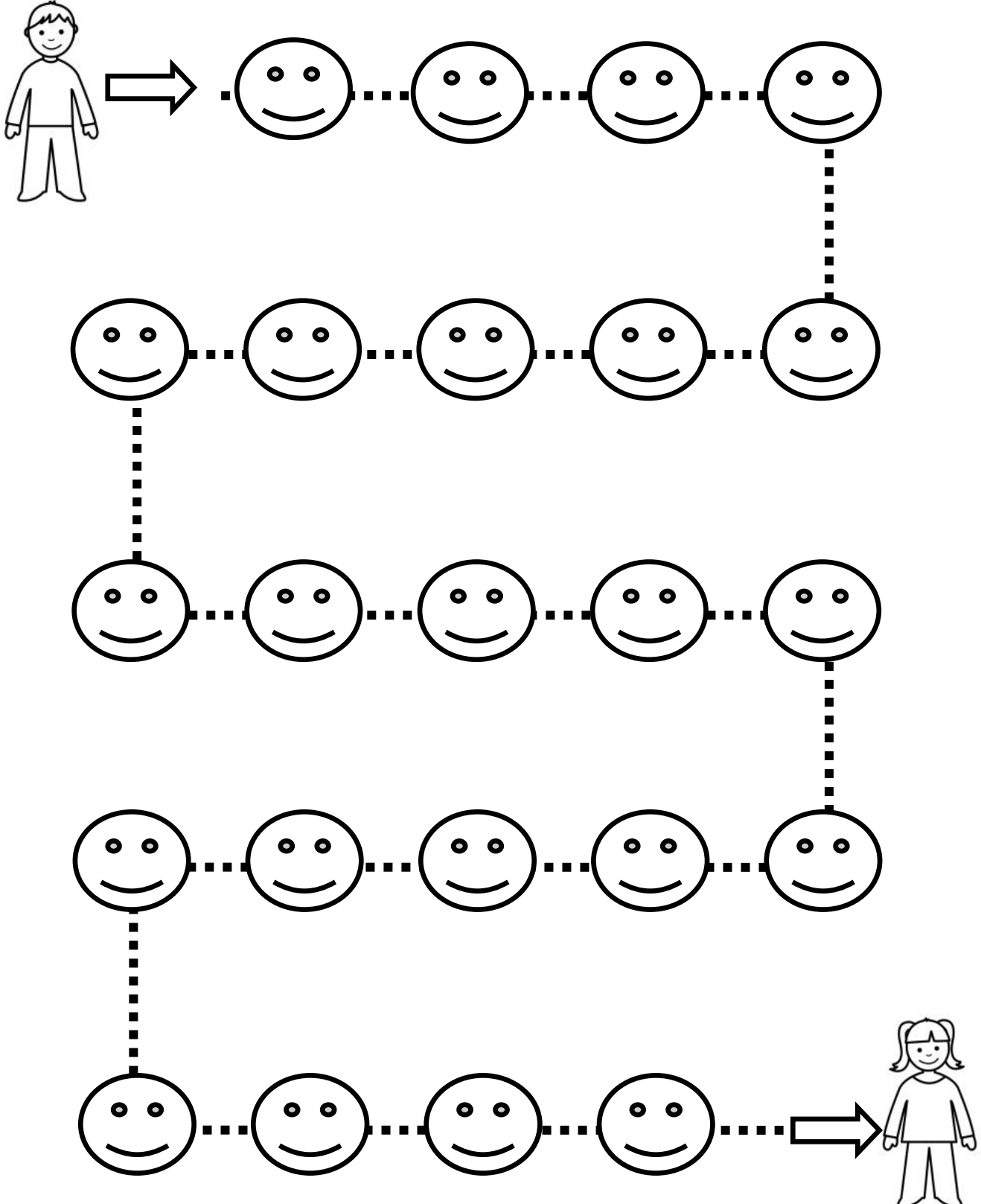

Actividades para mejorar la psicomotricidad

Sigue las caras para unir al niño y a la niña

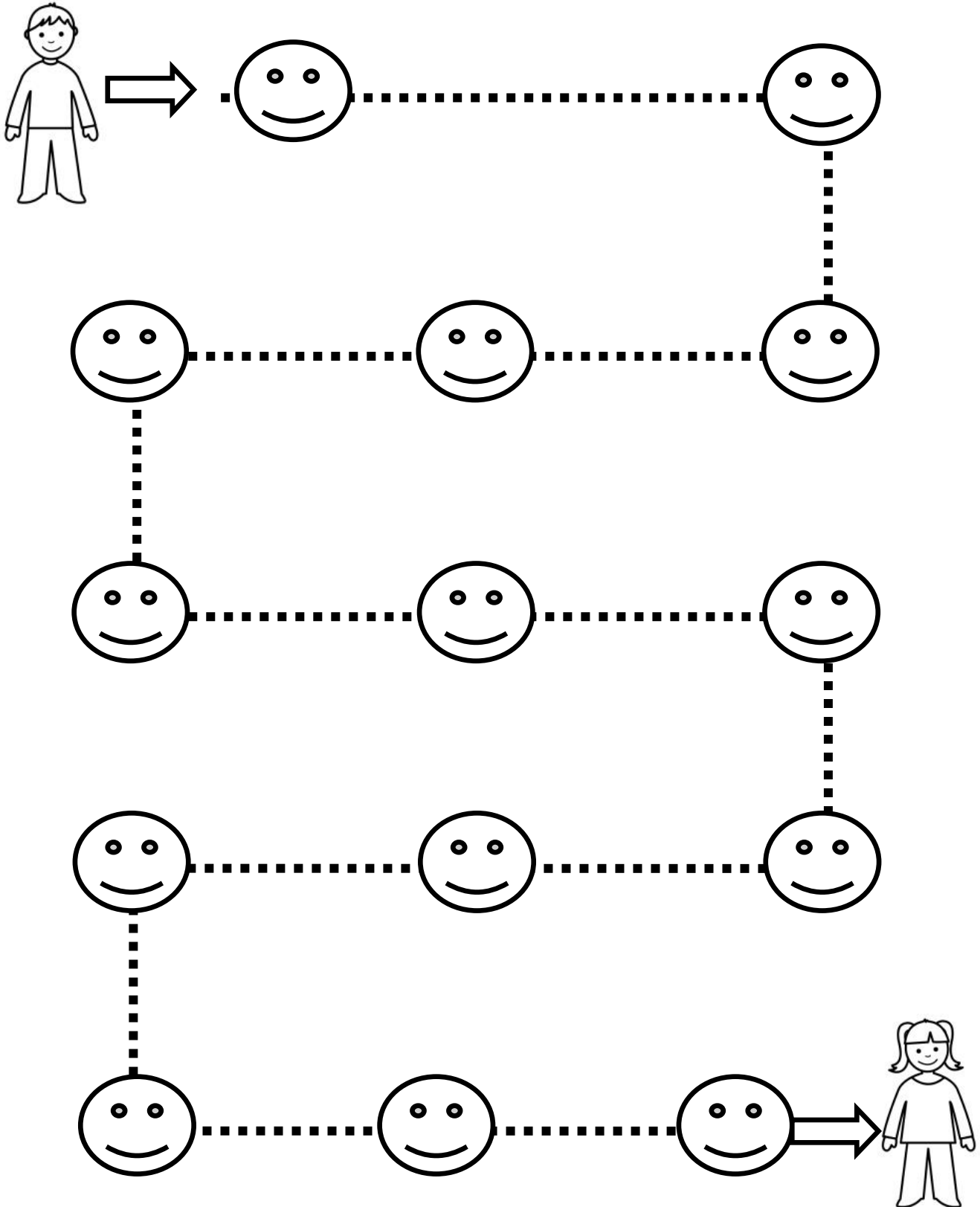

Actividades para mejorar la psicomotricidad

Sigue las caras para unir al niño y a la niña

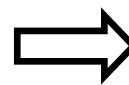
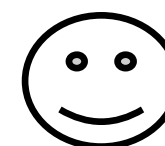
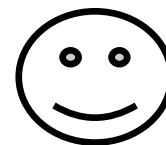
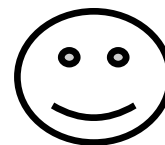
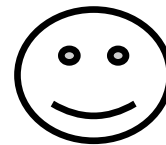
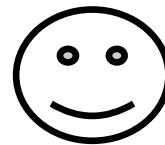
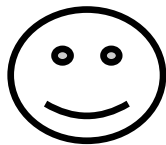
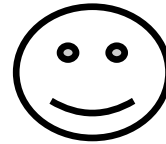
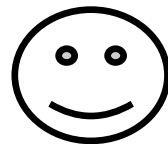
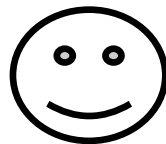
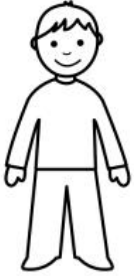

Actividades para mejorar la psicomotricidad

Sigue las caras para unir al niño y a la niña

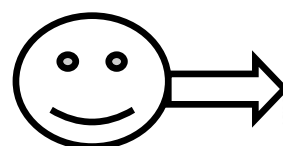
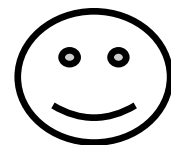
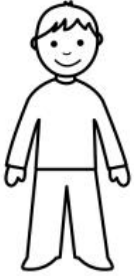

Actividades para mejorar la psicomotricidad

Sigue los círculos para unir al niño con su balón

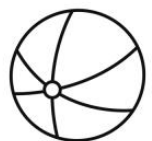
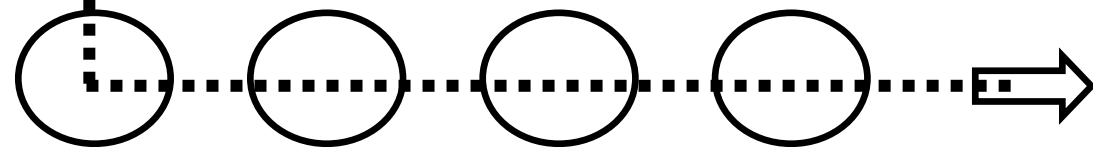
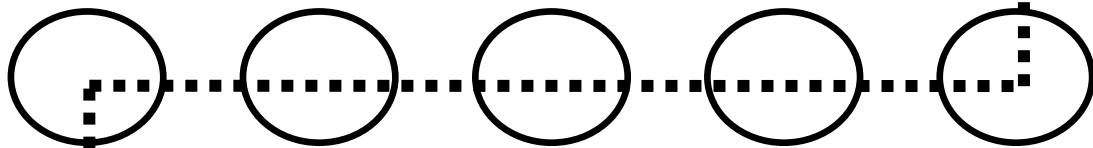
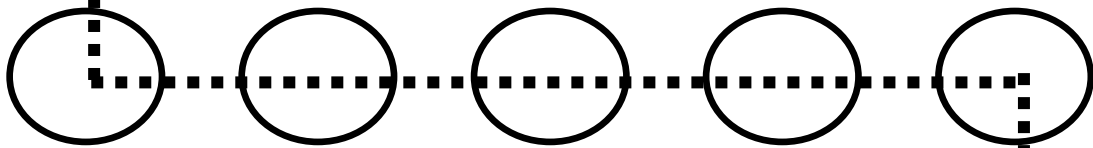
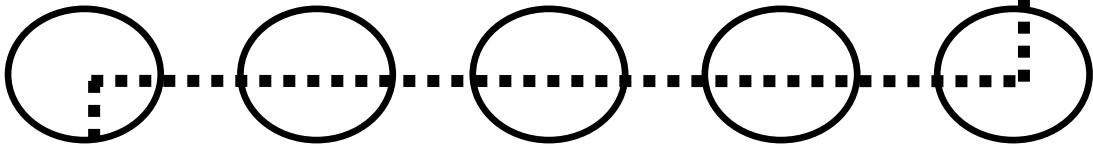
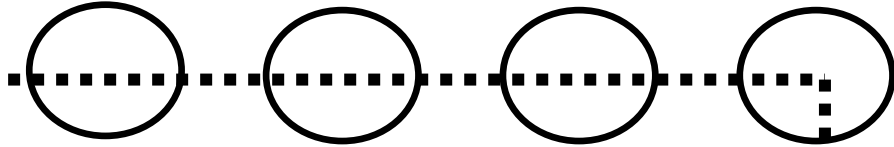
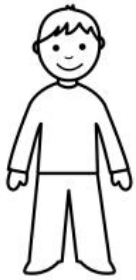

Actividades para mejorar la psicomotricidad

Sigue los círculos para unir al niño con su balón

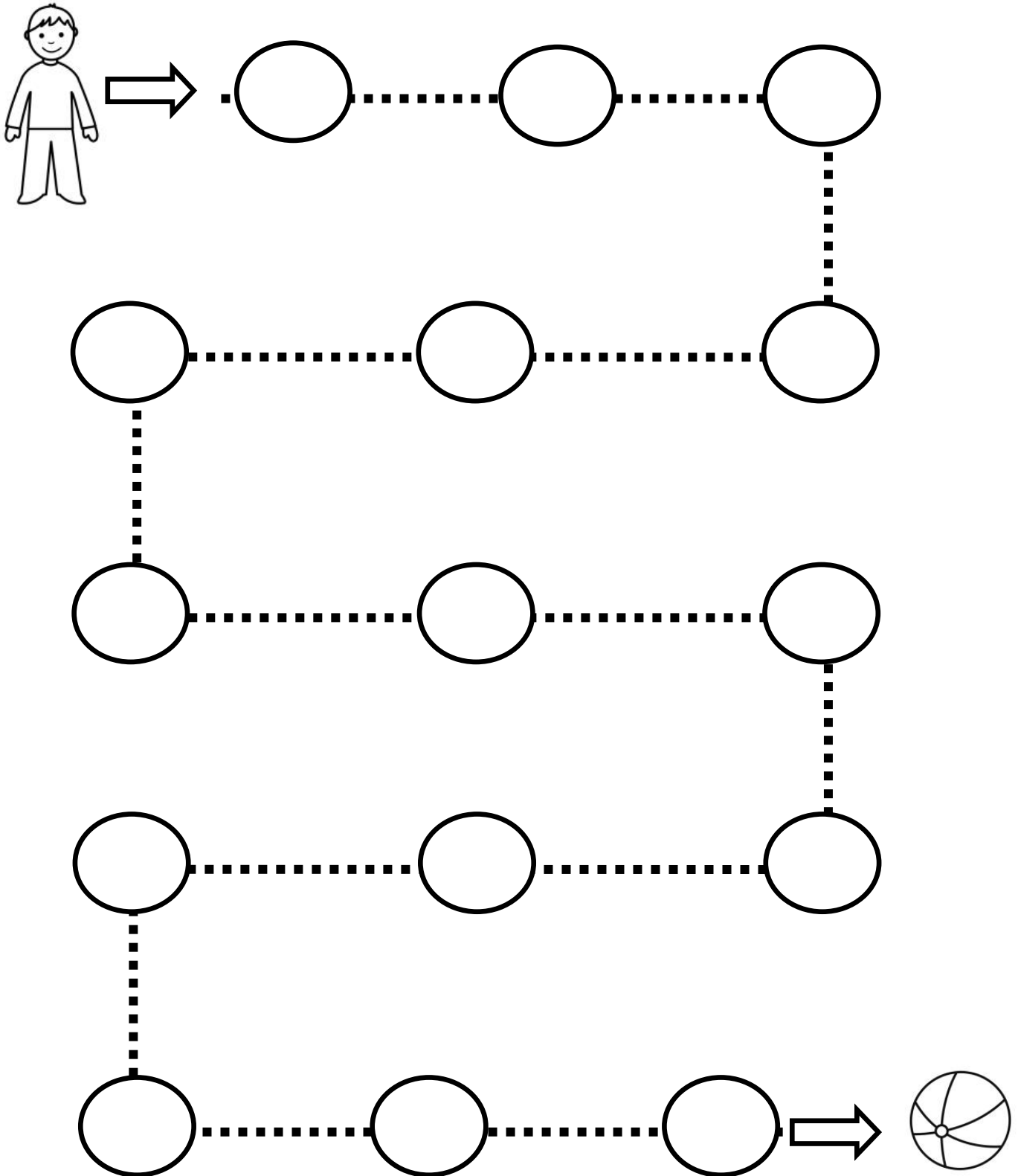

Actividades para mejorar la psicomotricidad

Sigue los círculos para unir al niño con su balón

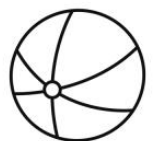
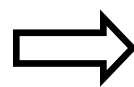
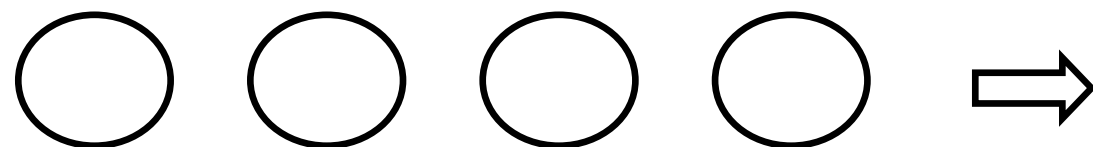
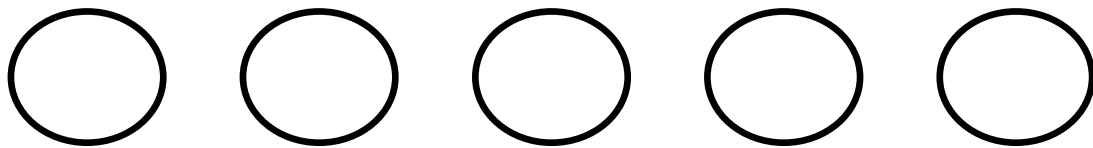
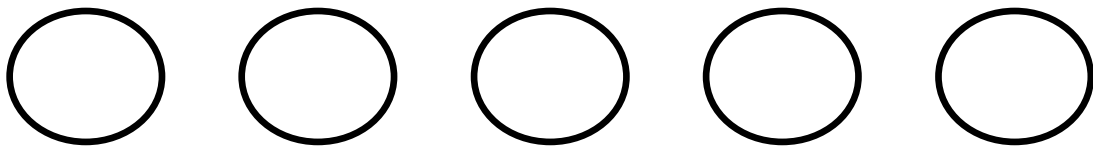
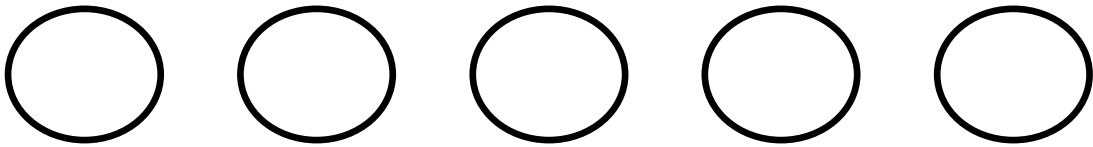
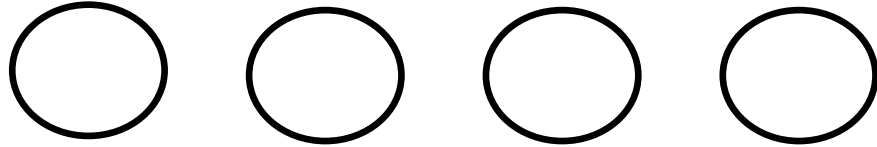
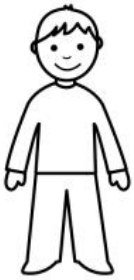

Actividades para mejorar la psicomotricidad

Sigue los círculos para unir al niño con su balón

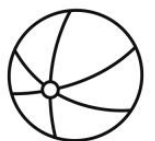
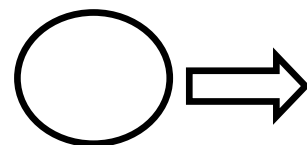
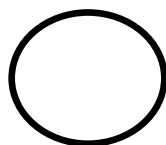
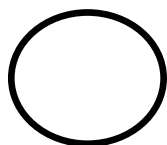
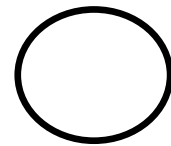
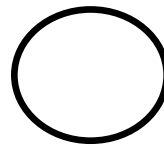
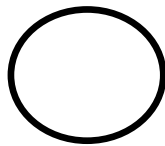
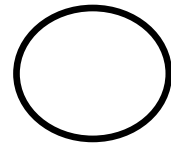
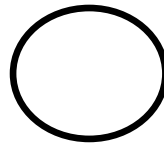
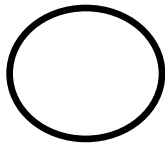
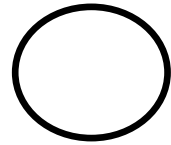
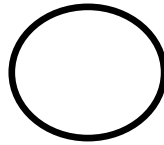
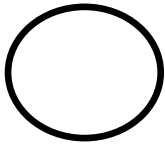
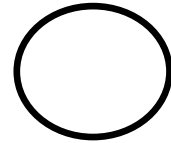
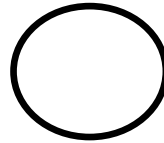
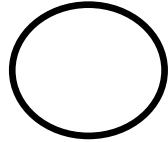
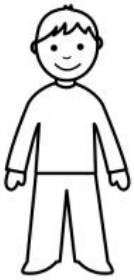

Actividades para mejorar la psicomotricidad

Sigue los rayos para unir la nube con la tierra

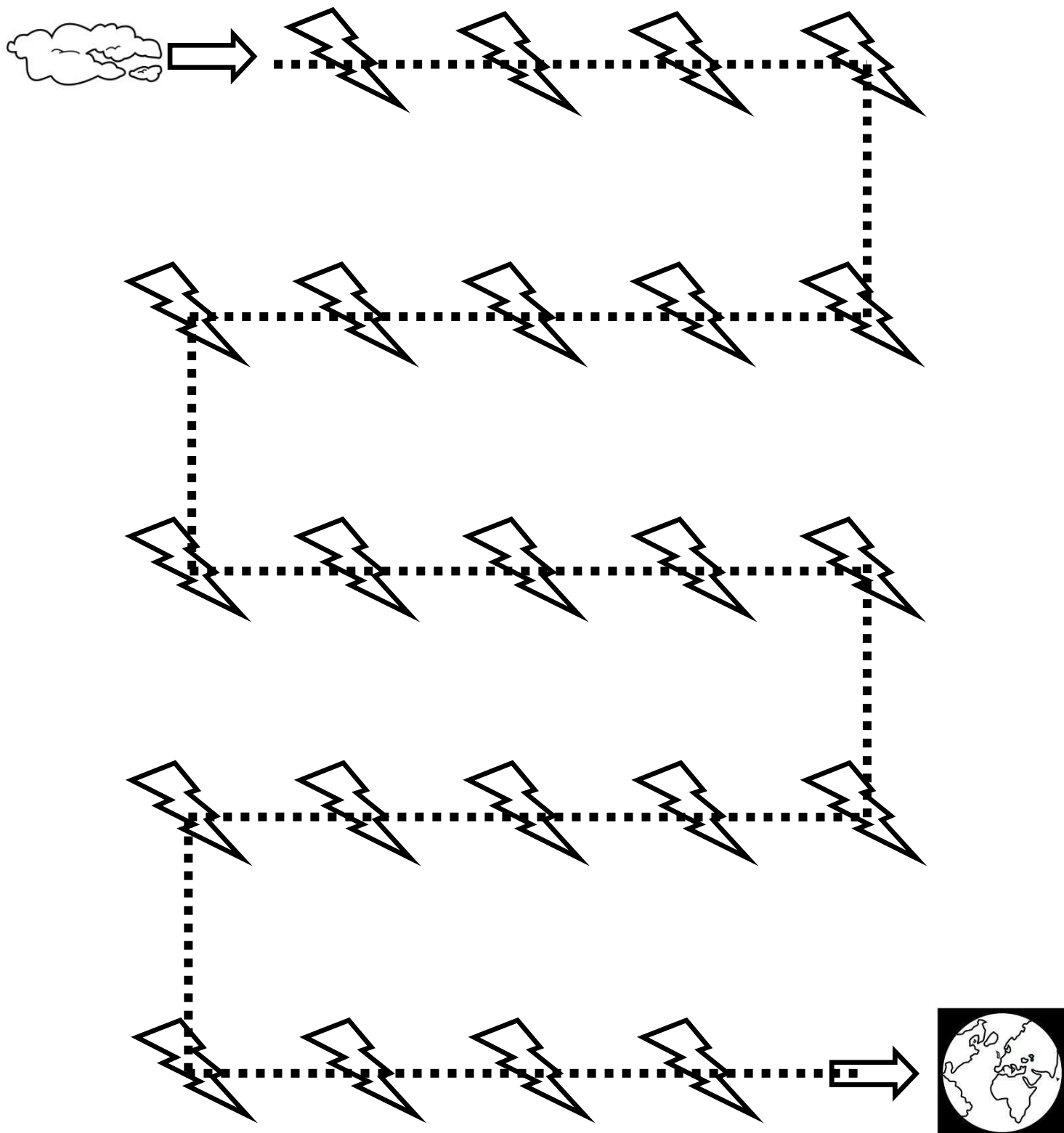

Actividades para mejorar la psicomotricidad

Sigue las caras para unir al niño y a la niña

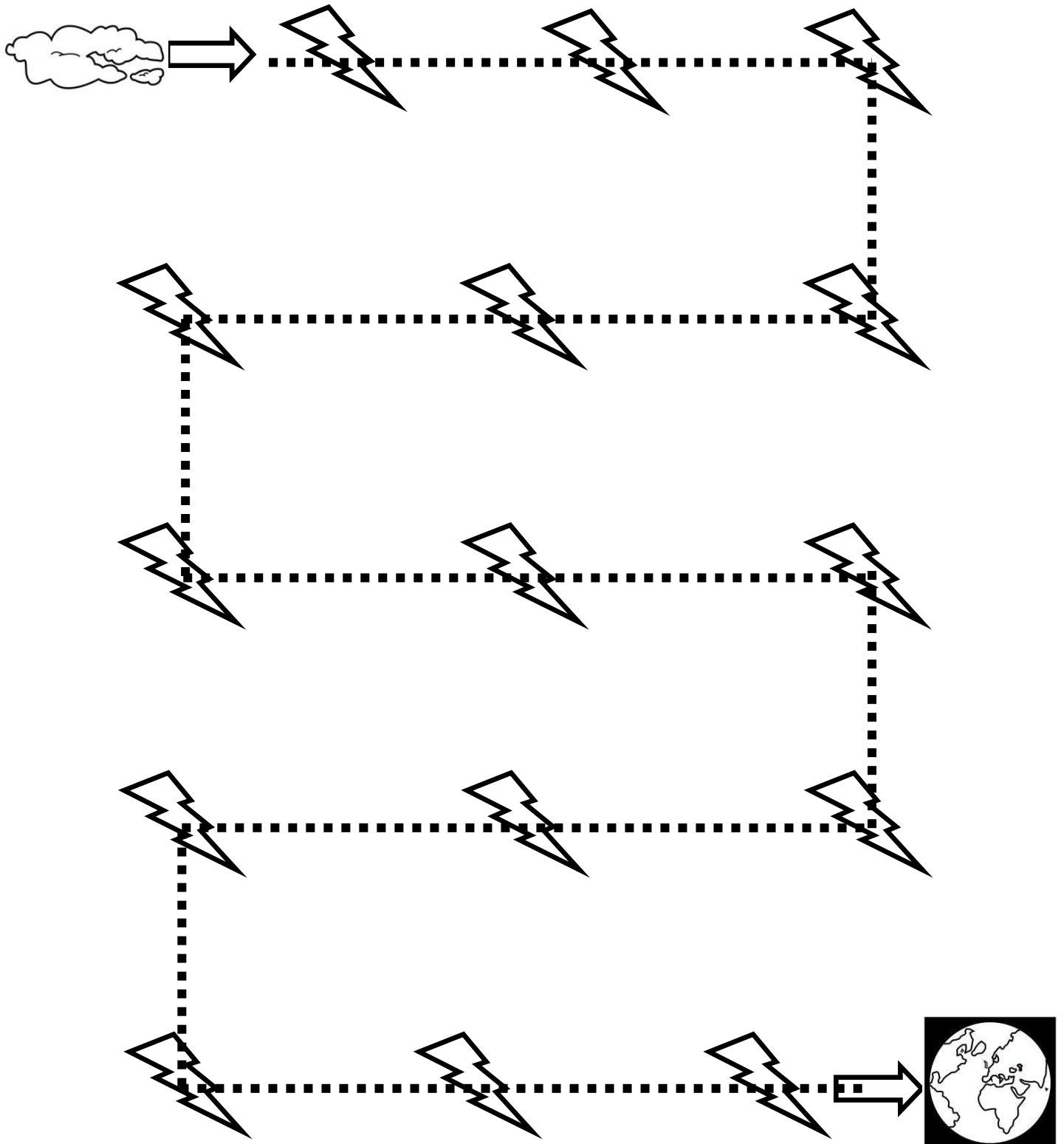

Actividades para mejorar la psicomotricidad

Sigue las caras para unir al niño y a la niña

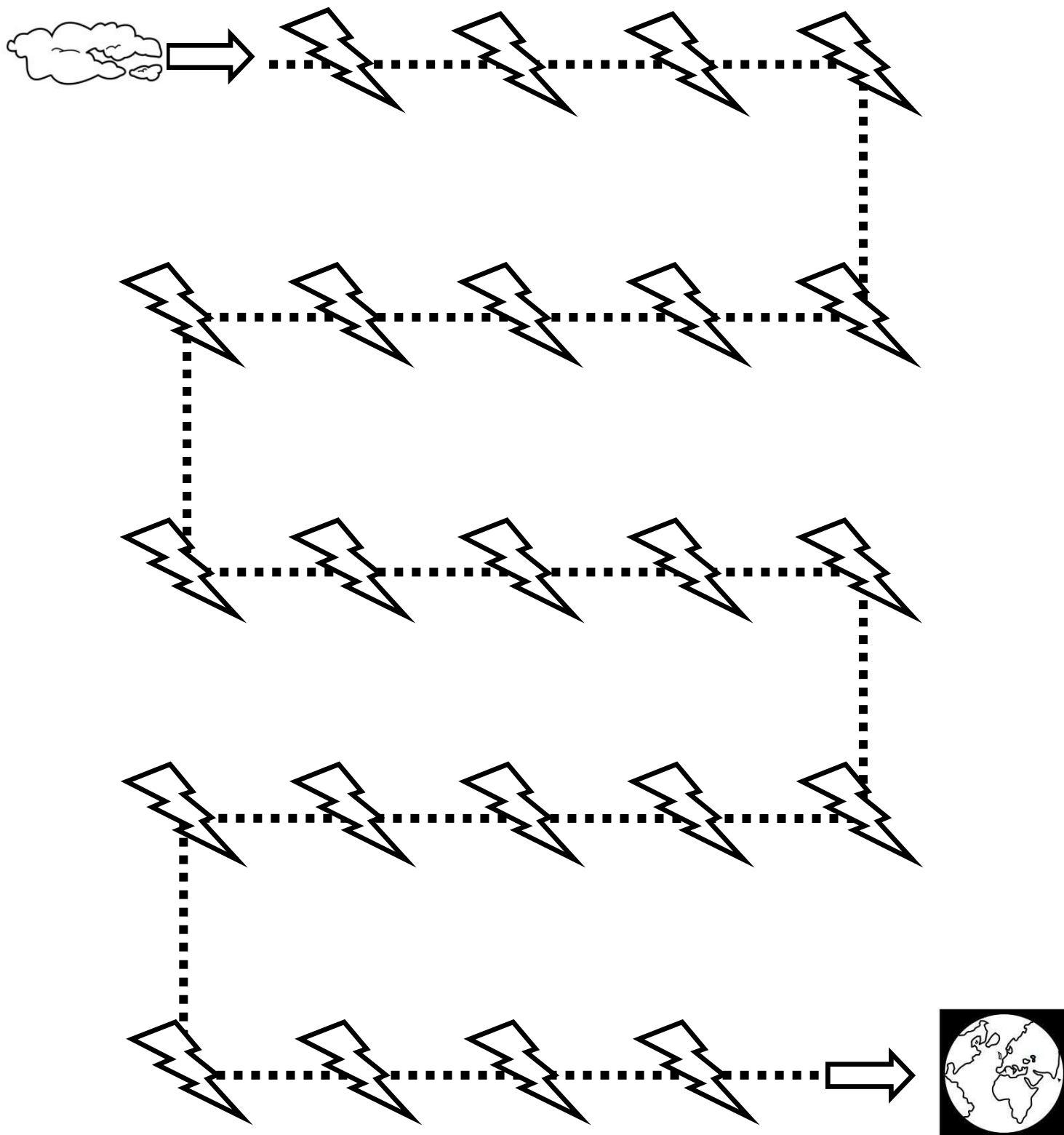

Actividades para mejorar la psicomotricidad

Sigue las caras para unir al niño y a la niña

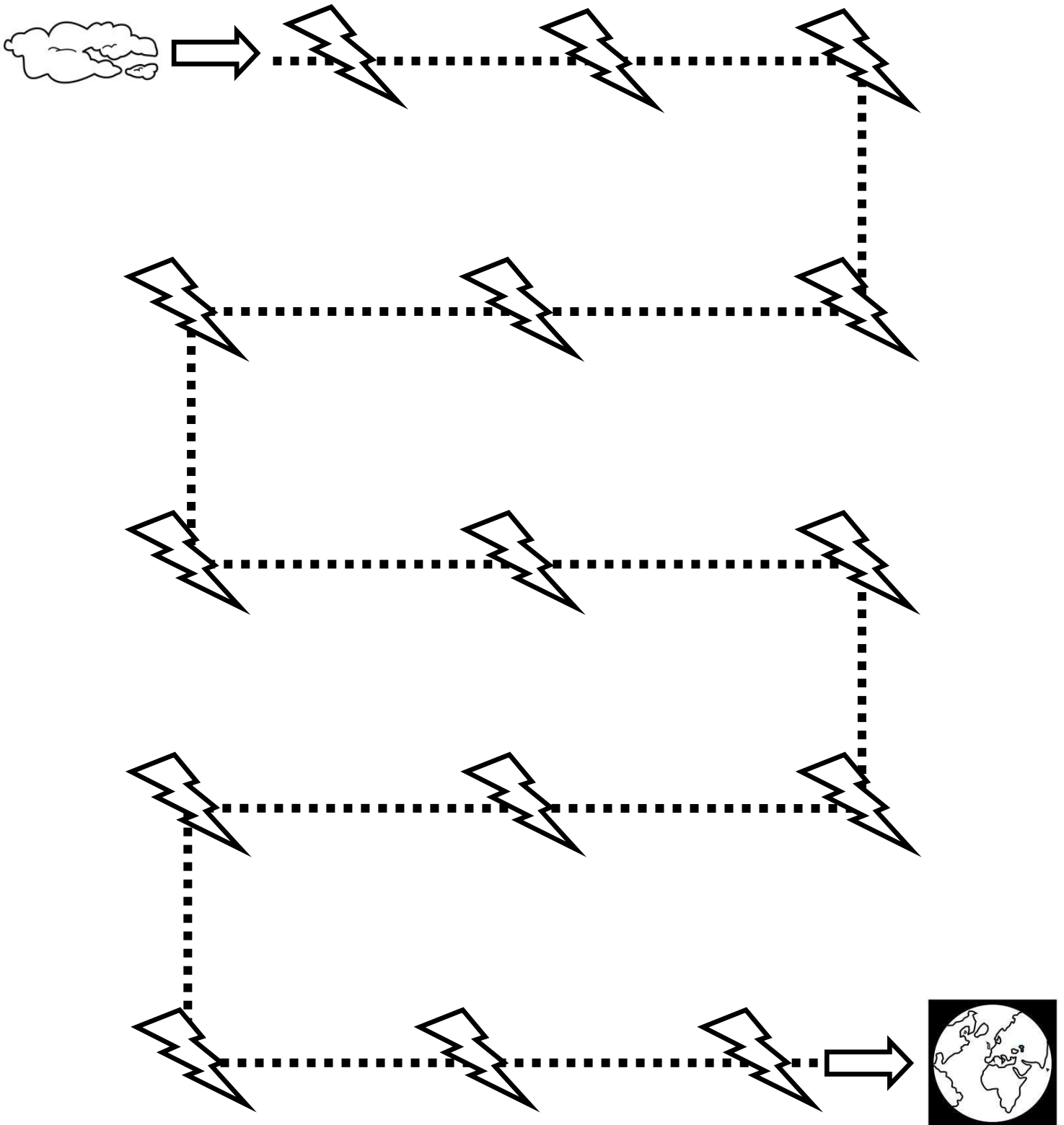

Actividades para mejorar la psicomotricidad

Sigue las caras para unir al niño y a la niña

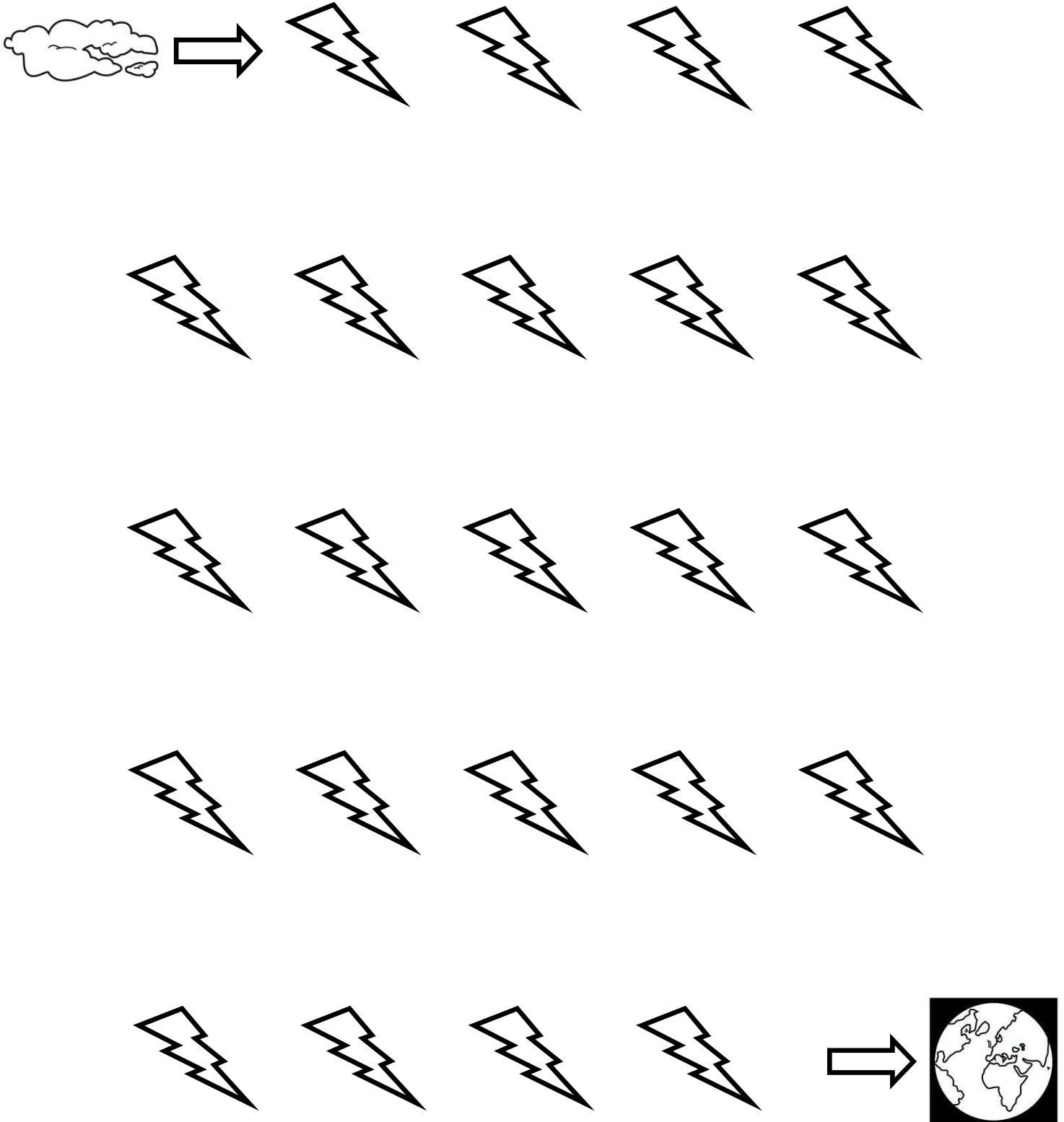

Actividades para mejorar la psicomotricidad

Sigue las caras para unir al niño y a la niña

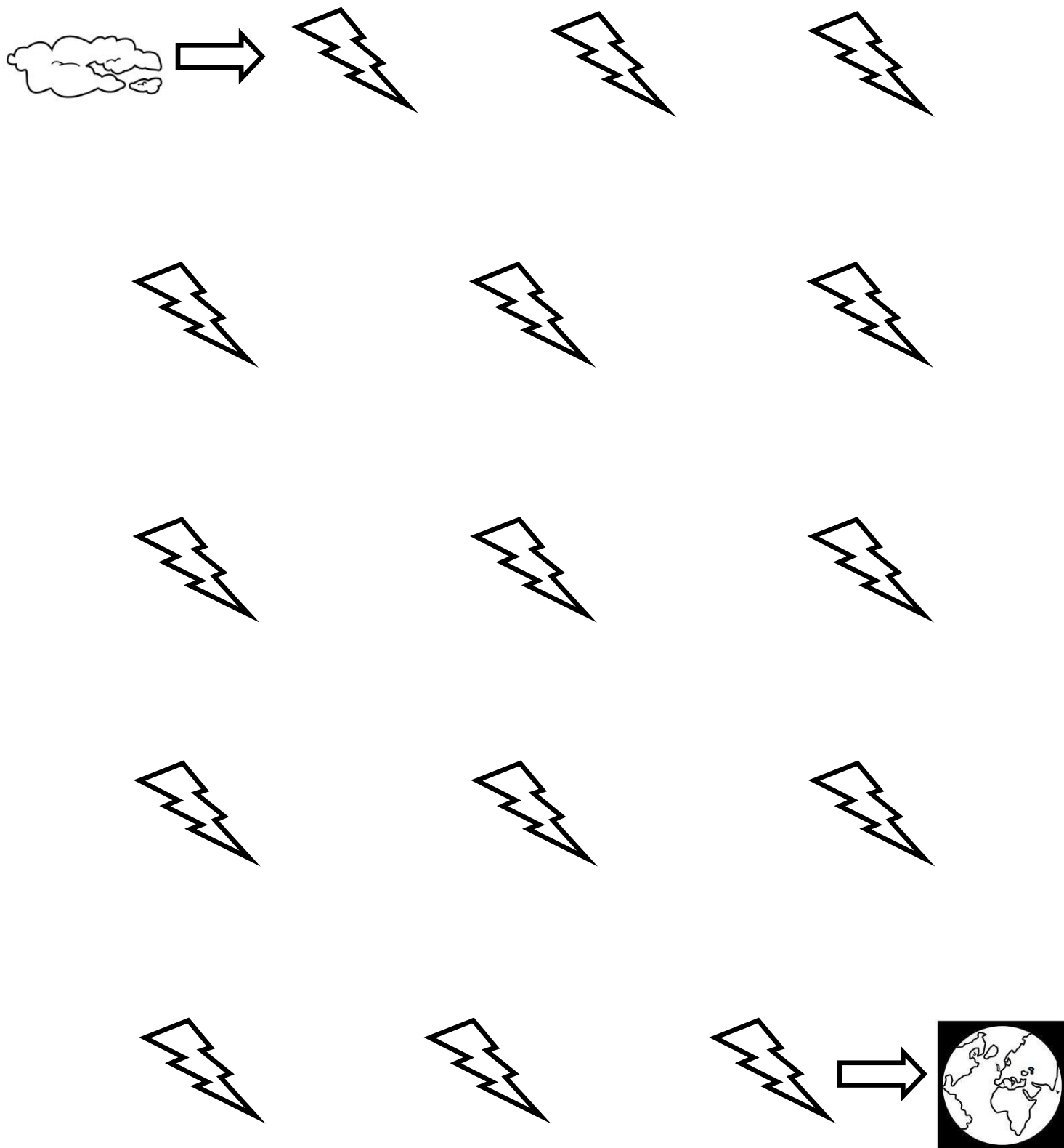

Actividades para mejorar motricidad fina

Sigue con tu lápiz las estrellitas para ir desde el sol a la tierra

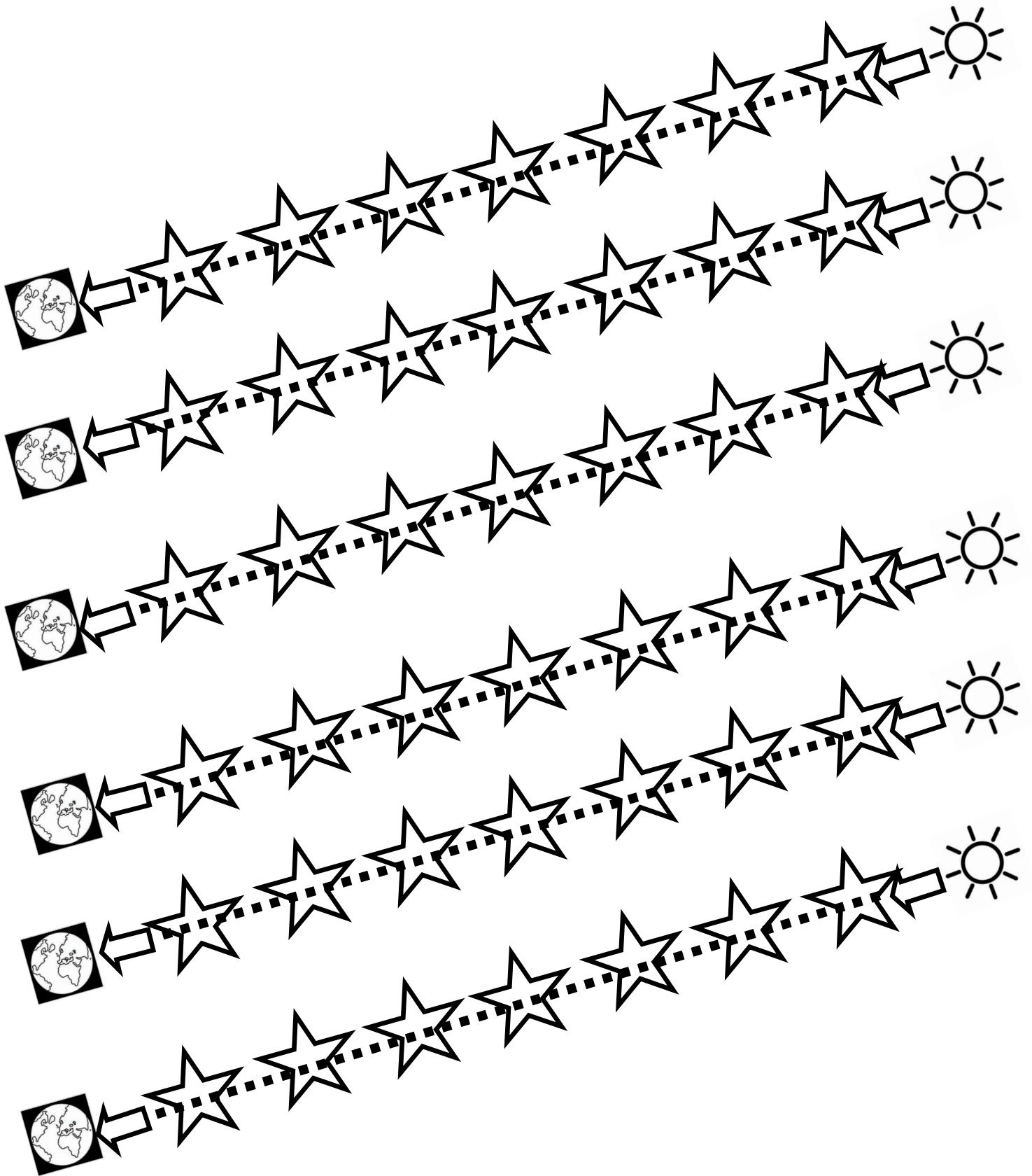

Actividades para mejorar motricidad fina

Sigue con tu lápiz las estrellitas para ir desde el sol a la tierra

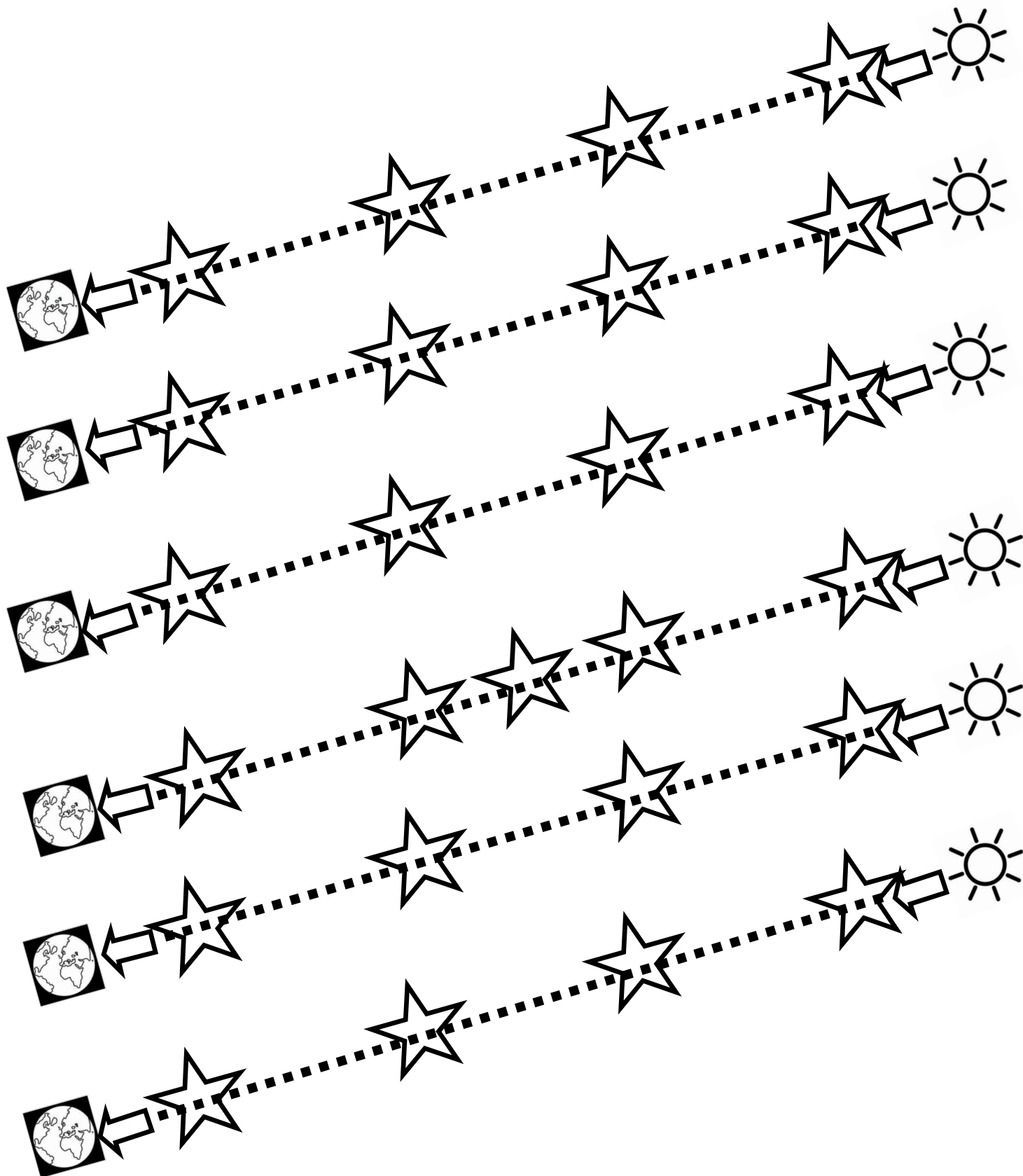

Actividades para mejorar motricidad fina

Sigue con tu lápiz las estrellitas para ir desde el sol a la tierra

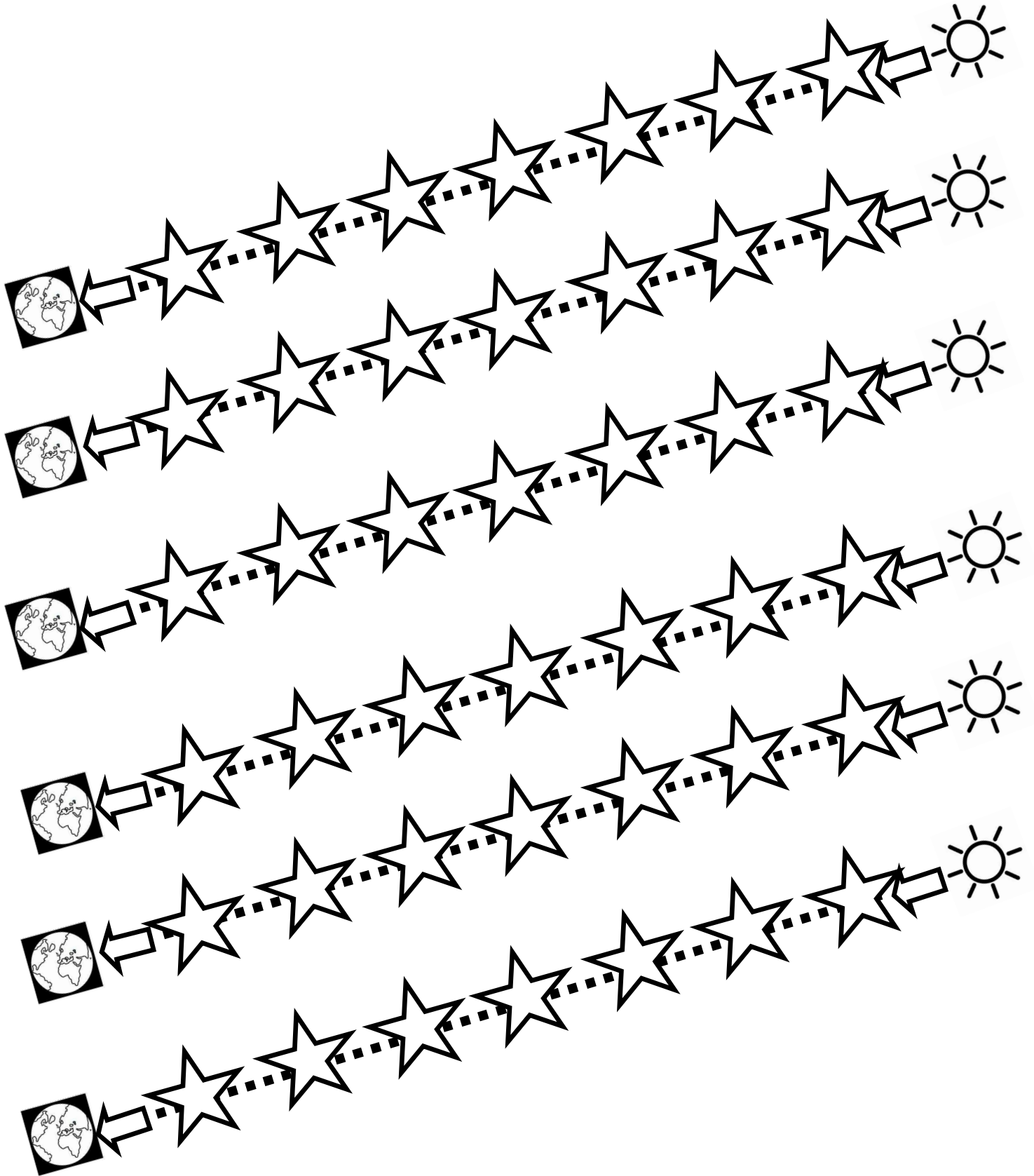

Actividades para mejorar motricidad fina

Sigue con tu lápiz las estrellitas para ir desde el sol a la tierra

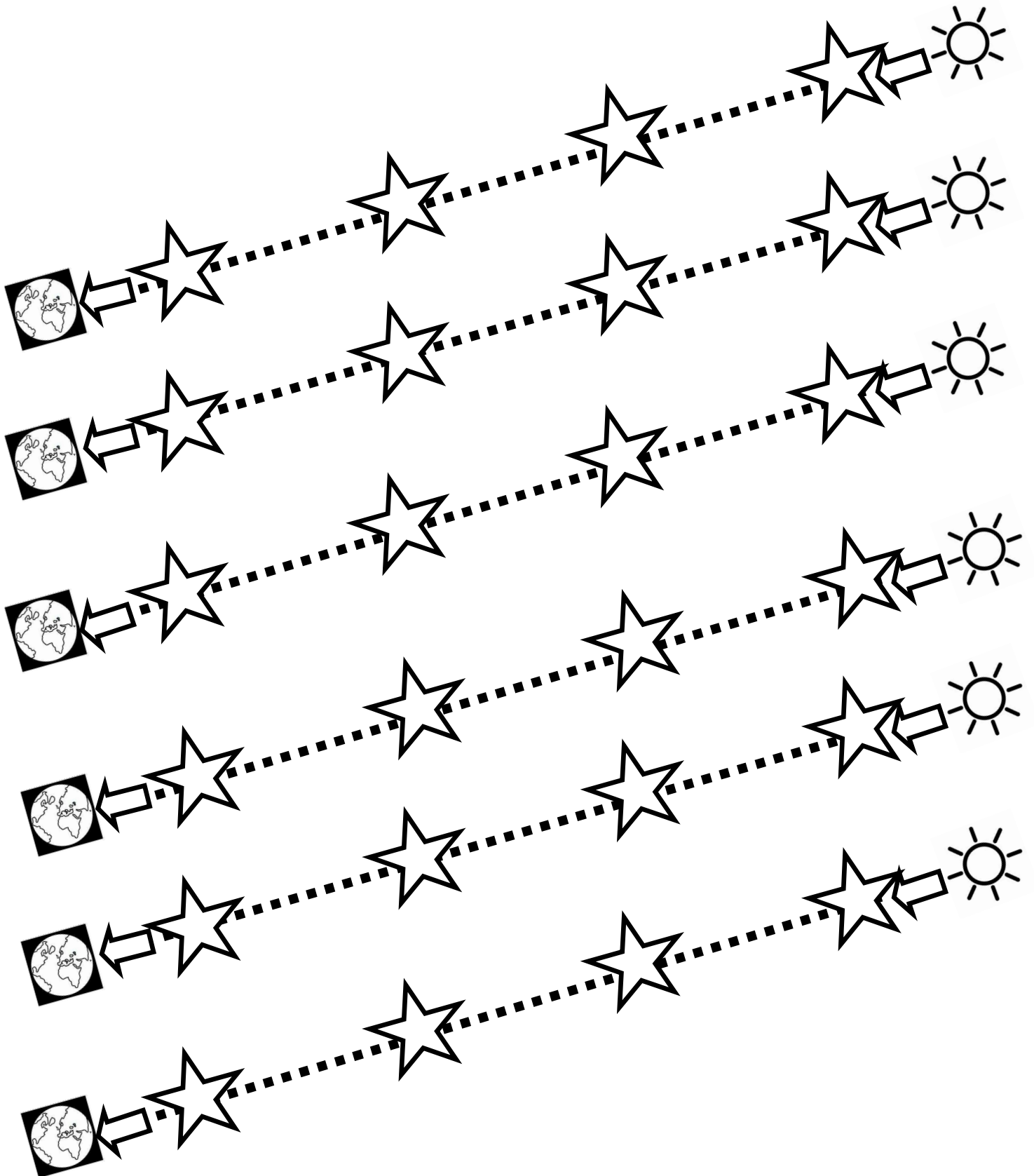

Actividades para mejorar motricidad fina

Sigue con tu lápiz las estrellitas para ir desde el sol a la tierra

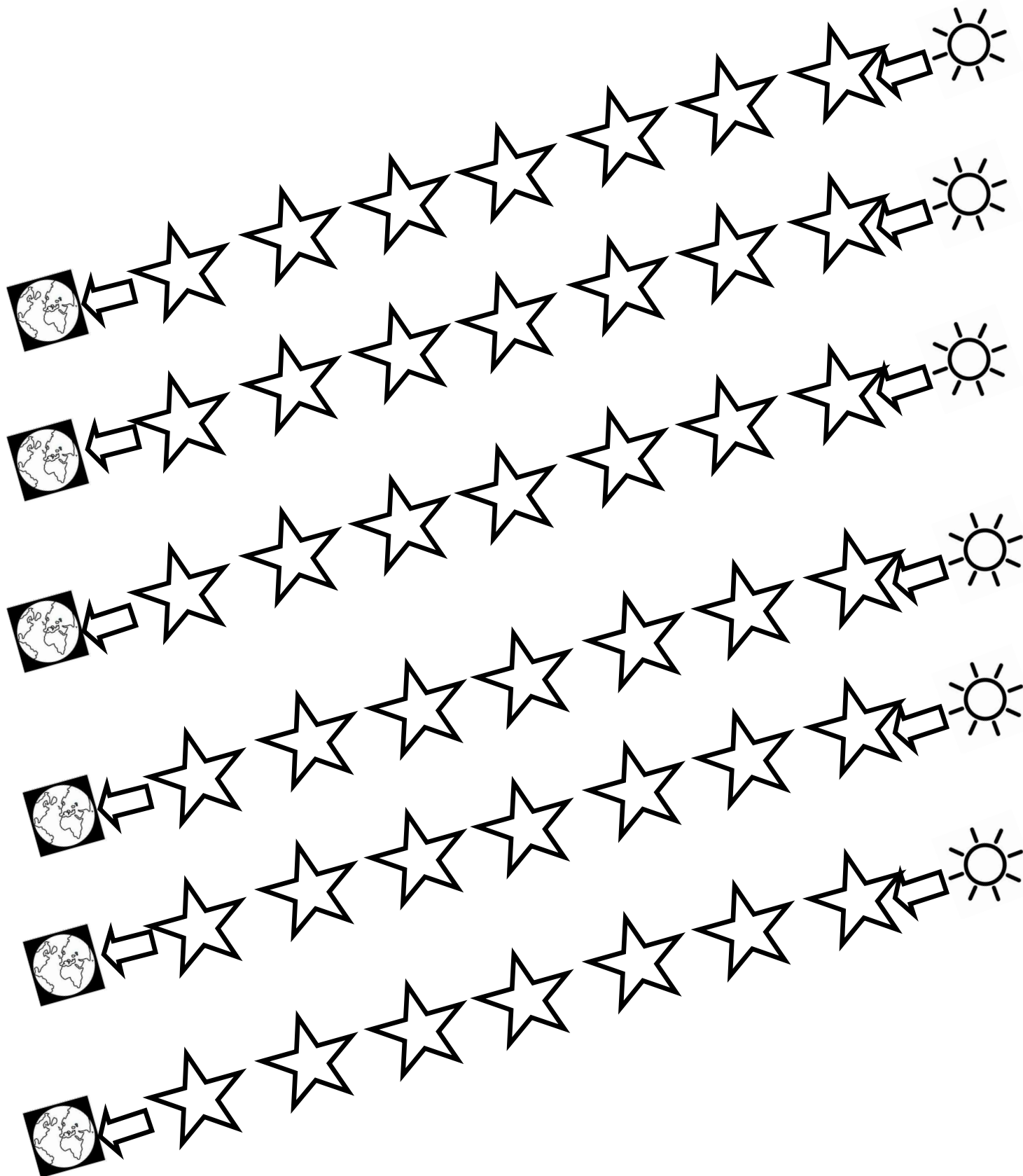

Actividades para mejorar motricidad fina

Sigue con tu lápiz las estrellitas para ir desde el sol a la tierra



Actividades para mejorar motricidad fina

Sigue con tu lápiz los corazones para unir a la mama y a su bebe

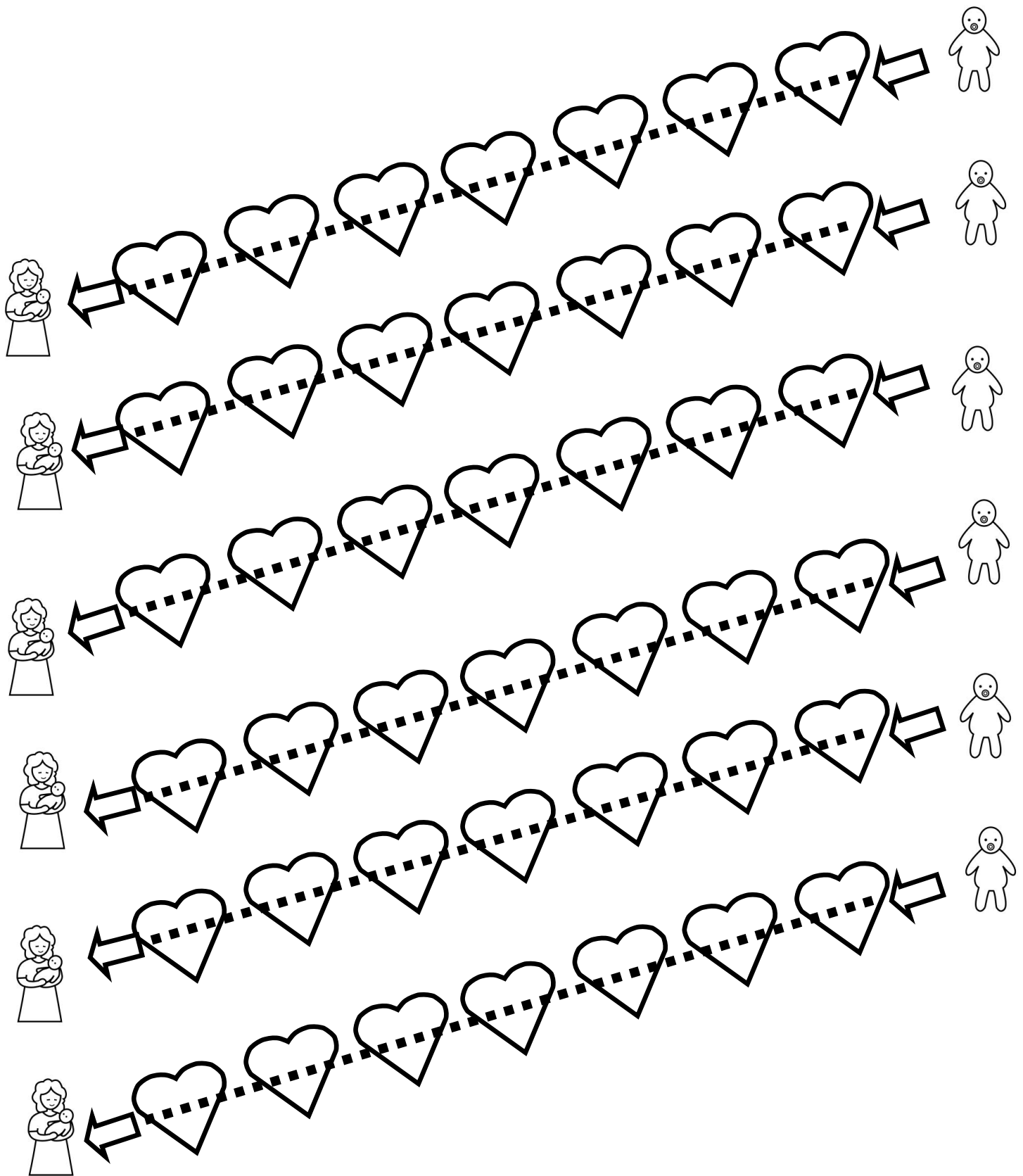

Actividades para mejorar motricidad fina

Sigue con tu lápiz los corazones para unir a la mama y a su bebe

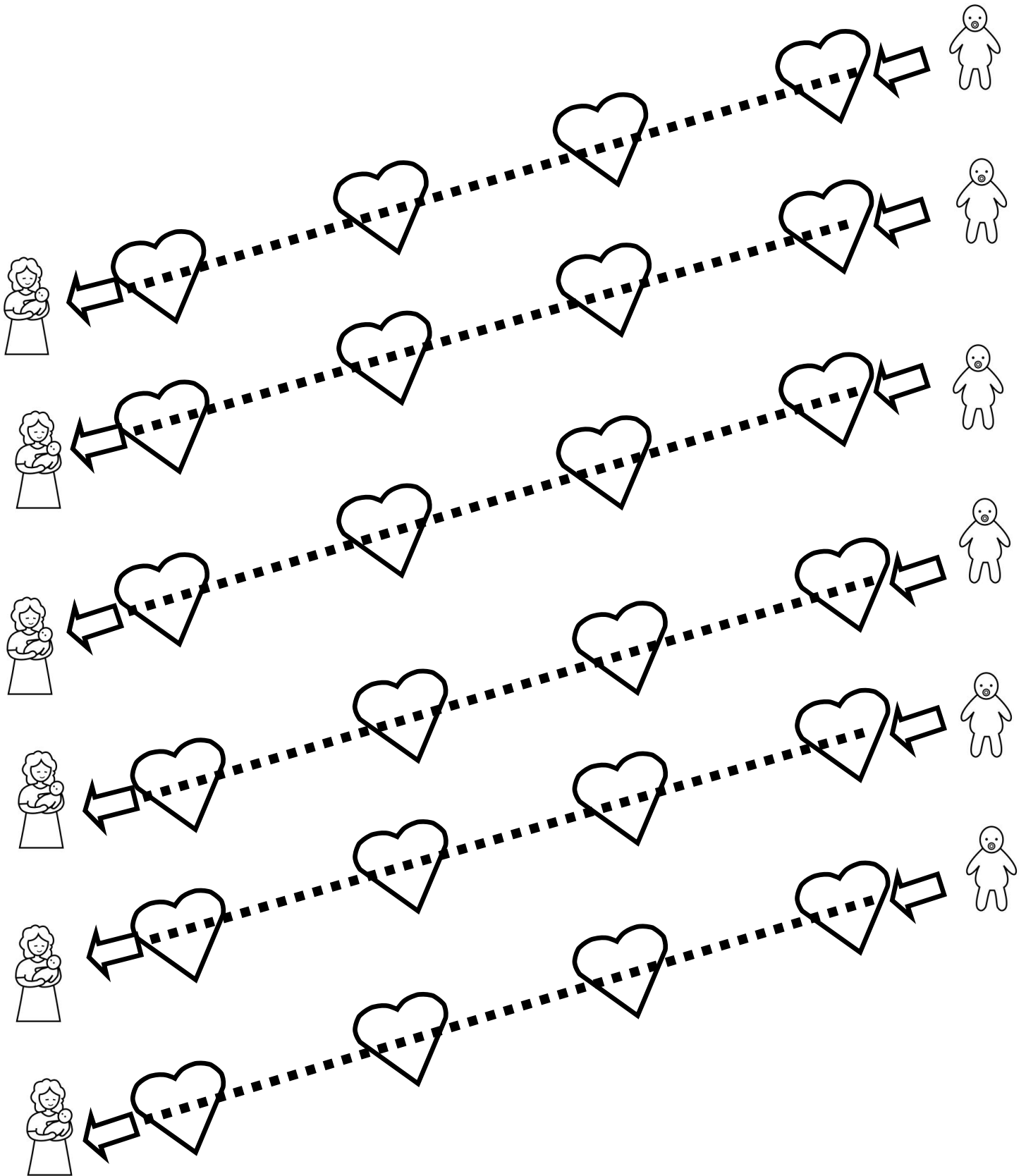

Actividades para mejorar motricidad fina

Sigue con tu lápiz los corazones para unir a la mama y a su bebe

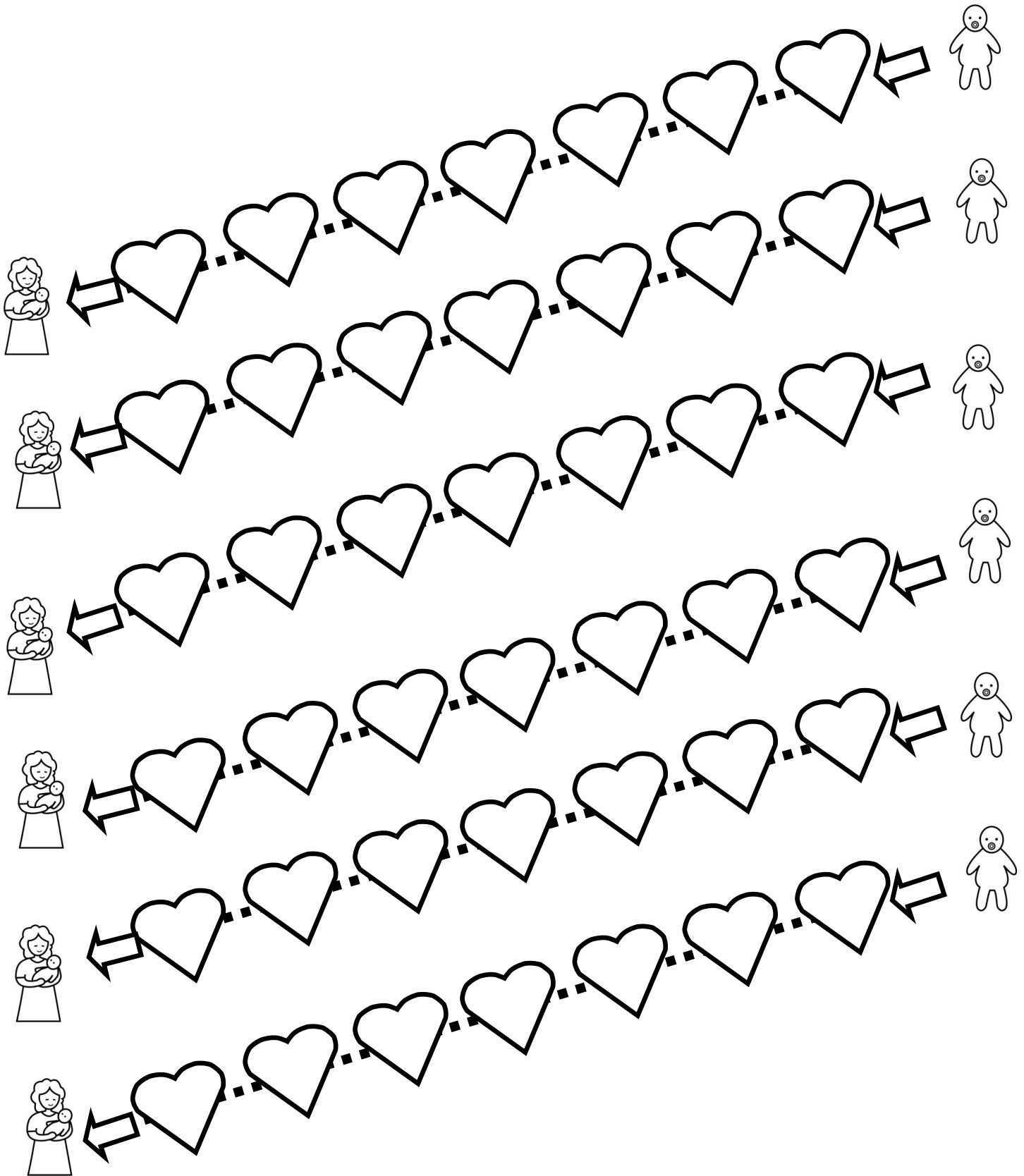

Actividades para mejorar motricidad fina

Sigue con tu lápiz los corazones para unir a la mama y a su bebe

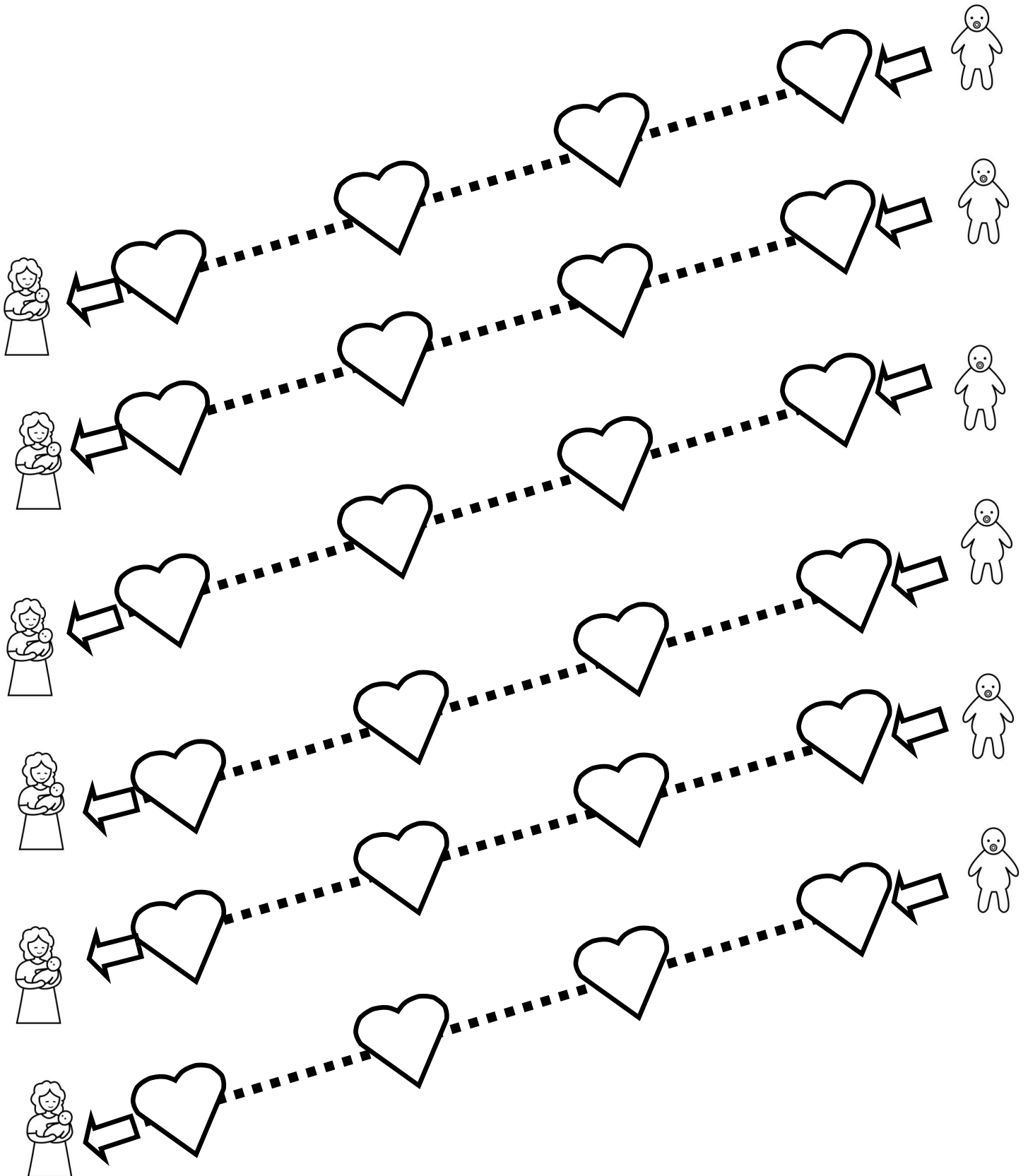

Actividades para mejorar motricidad fina

Sigue con tu lápiz los corazones para unir a la mama y a su bebe

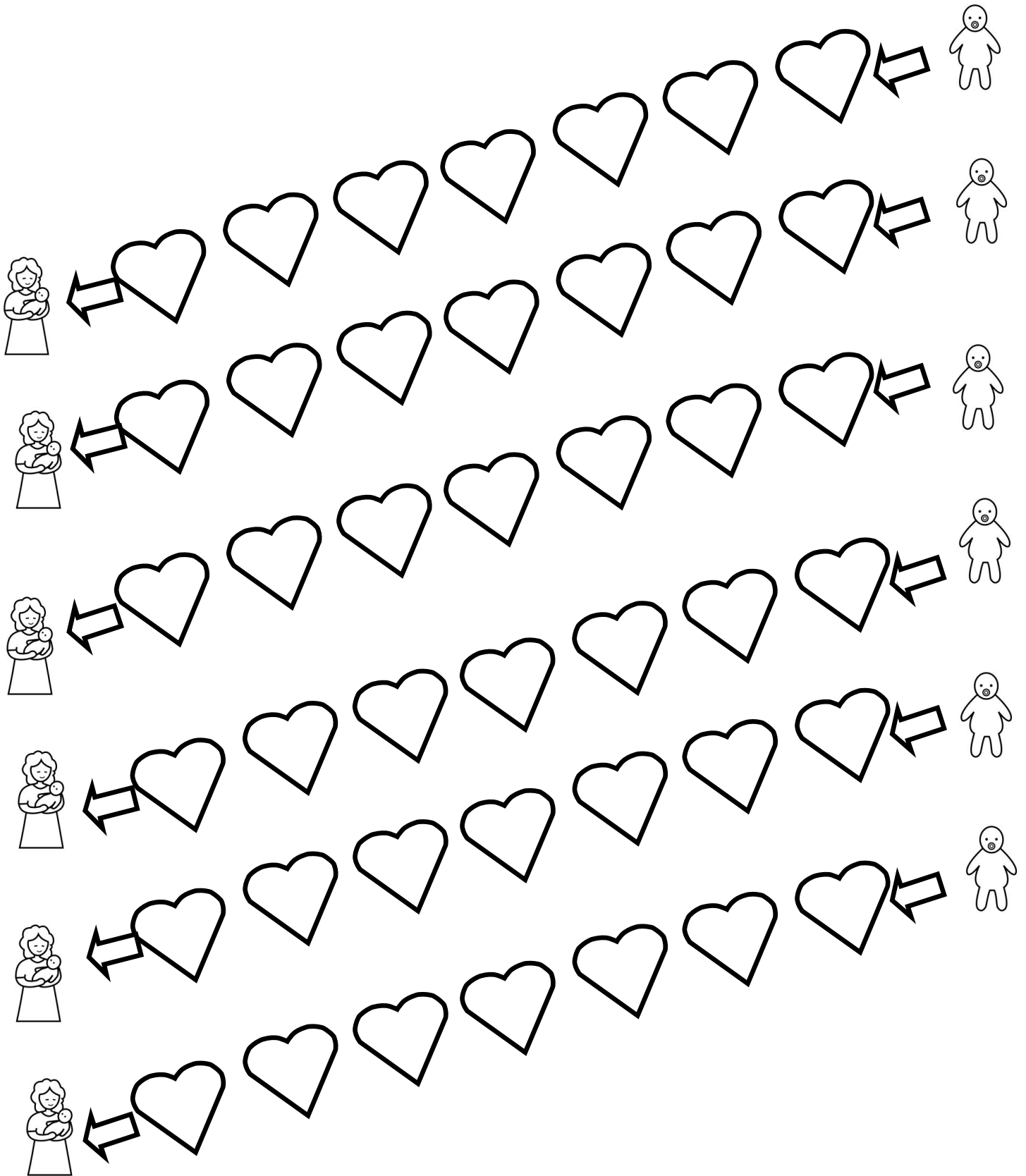

Actividades para mejorar motricidad fina

Sigue con tu lápiz los corazones para unir a la mama y a su bebe

Actividades para mejorar motricidad fina

Sigue con tu lápiz las caras para unir al niño con su amiga

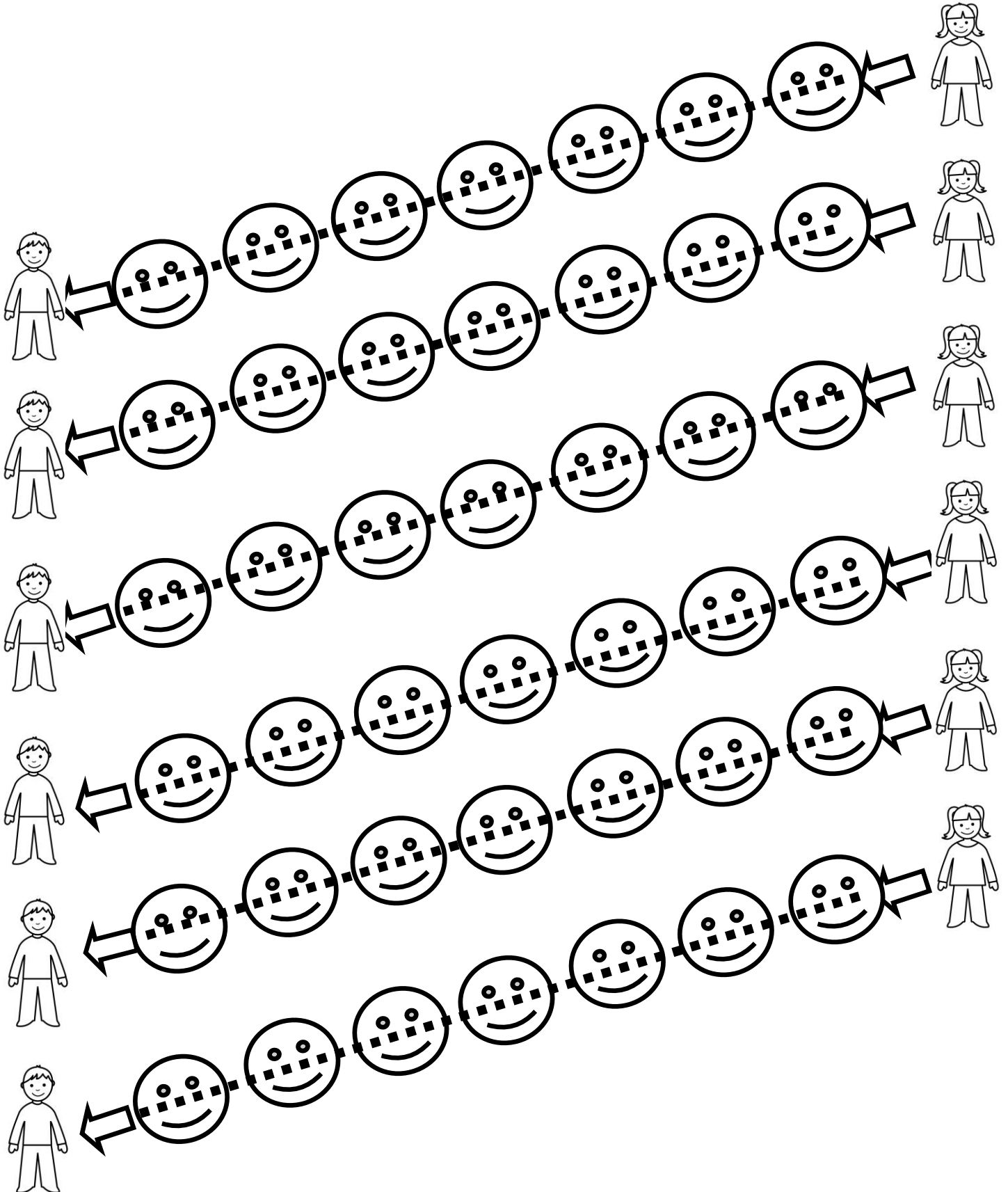

Actividades para mejorar motricidad fina

Sigue con tu lápiz las caras para unir al niño con su amiga

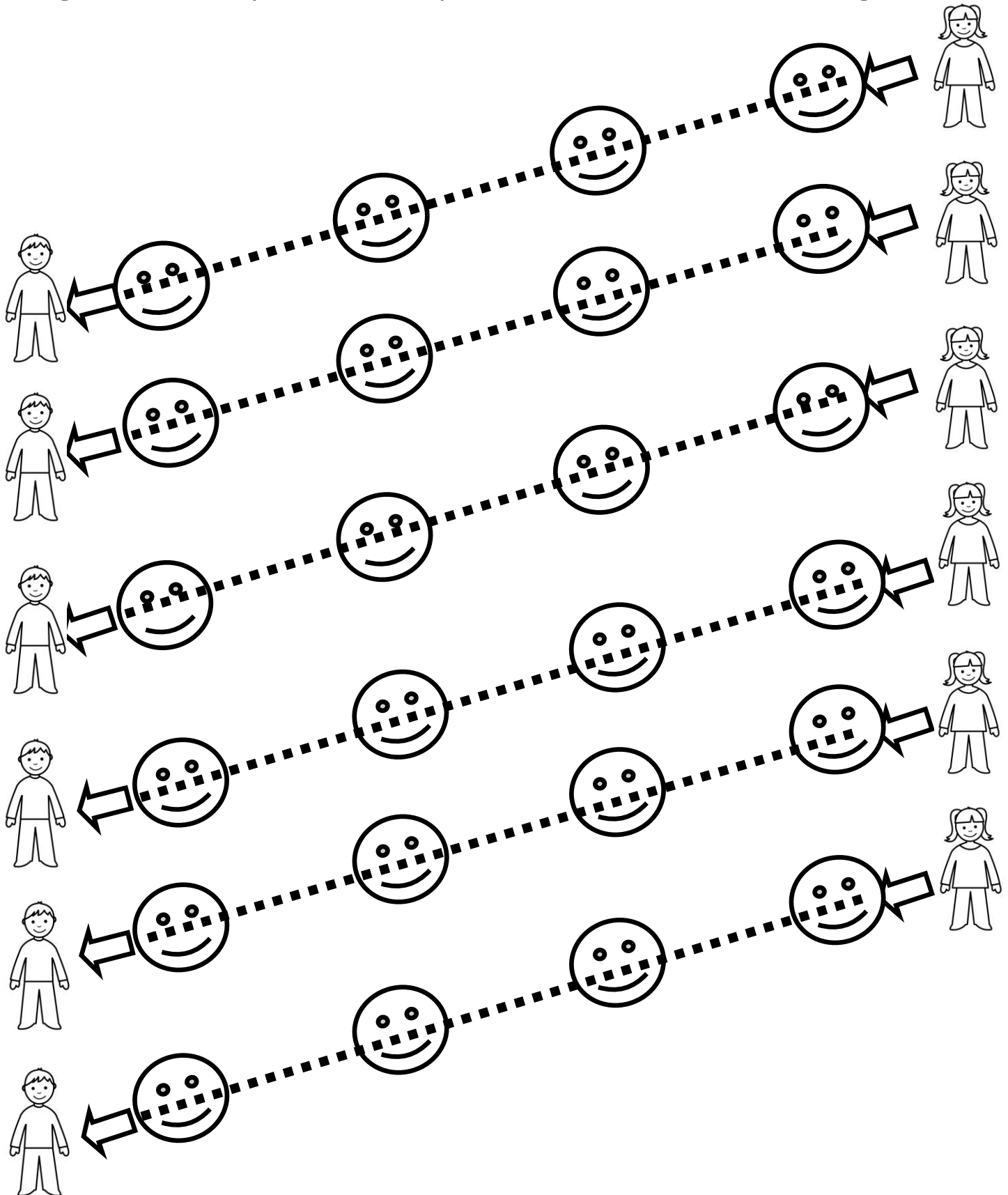

Actividades para mejorar motricidad fina

Sigue con tu lápiz las caras para unir al niño con su amiga

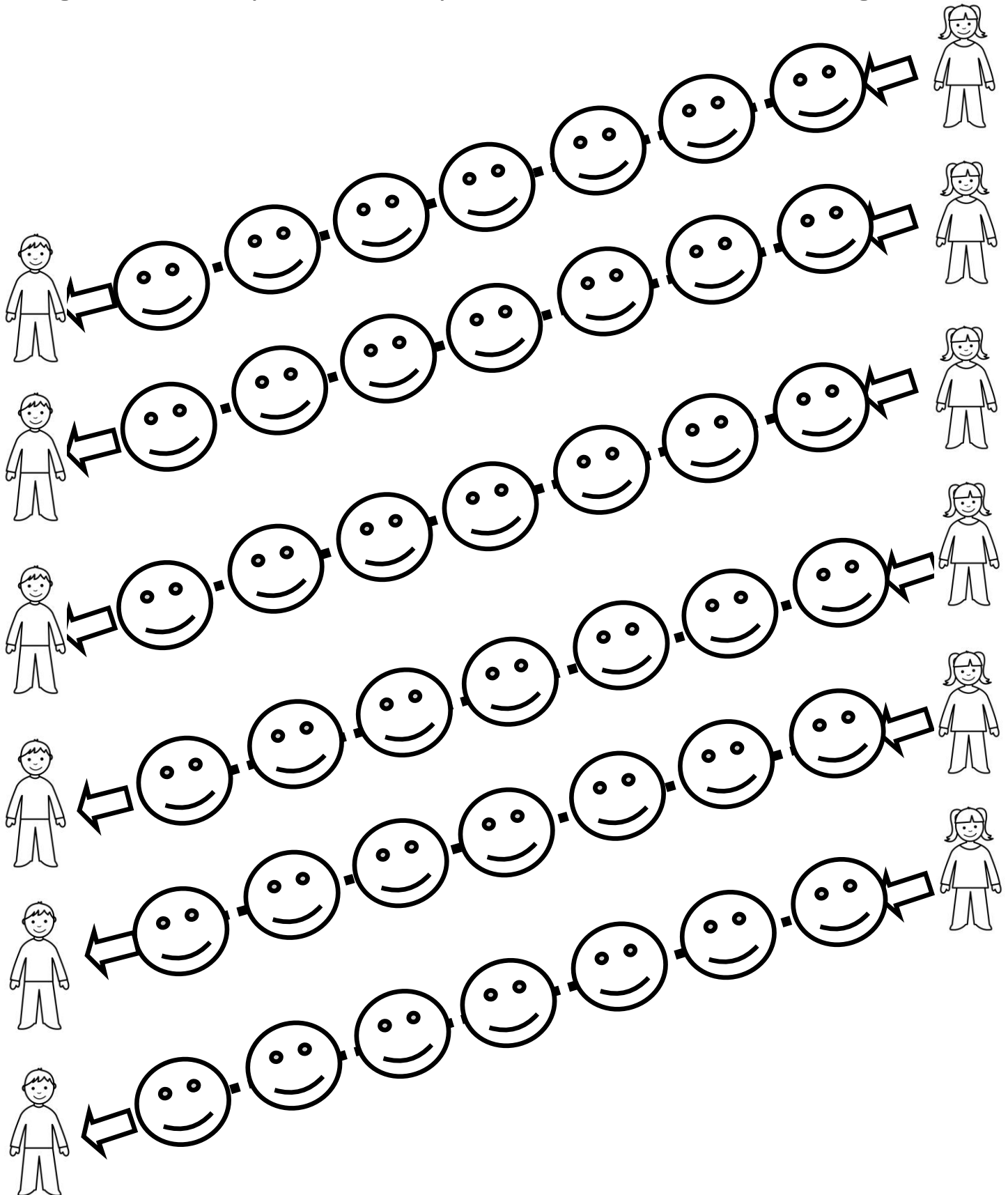

Actividades para mejorar motricidad fina

Sigue con tu lápiz las caras para unir al niño con su amiga

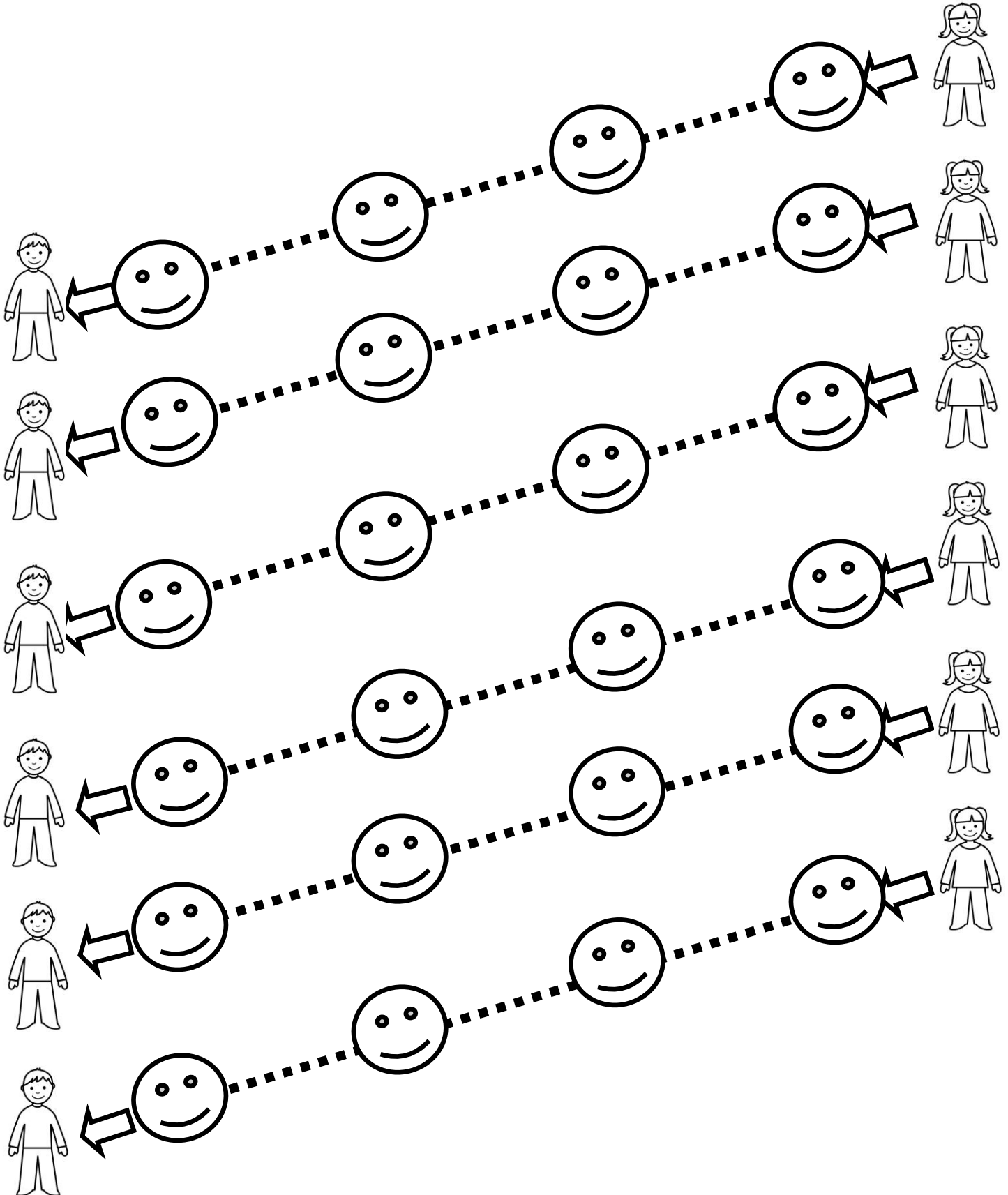

Actividades para mejorar motricidad fina

Sigue con tu lápiz las caras para unir al niño con su amiga

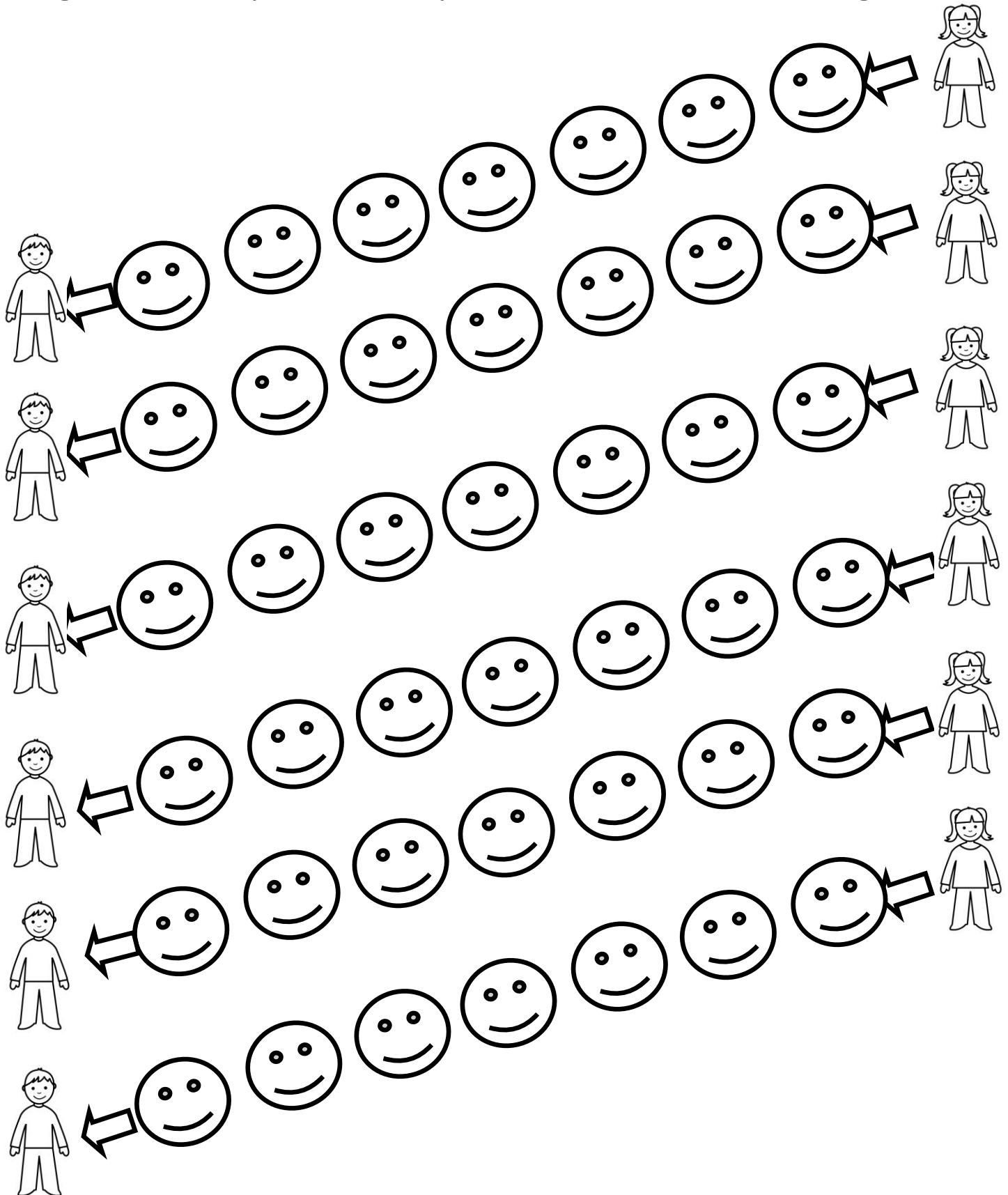

Actividades para mejorar motricidad fina

Sigue con tu lápiz las caras para unir al niño con su amiga

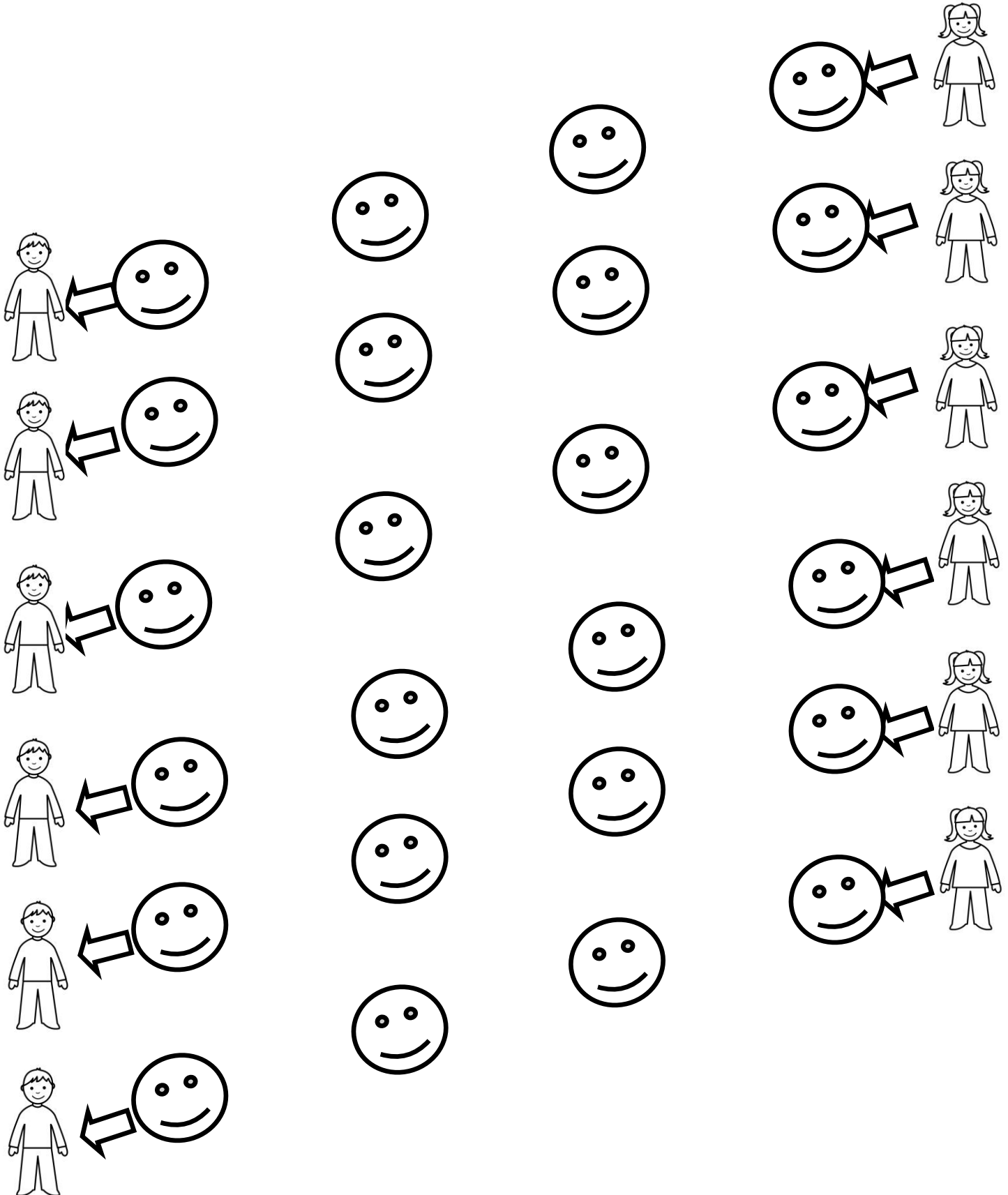

Actividades para mejorar motricidad fina

Sigue con tu lápiz los círculos para unir al niño con su pelota

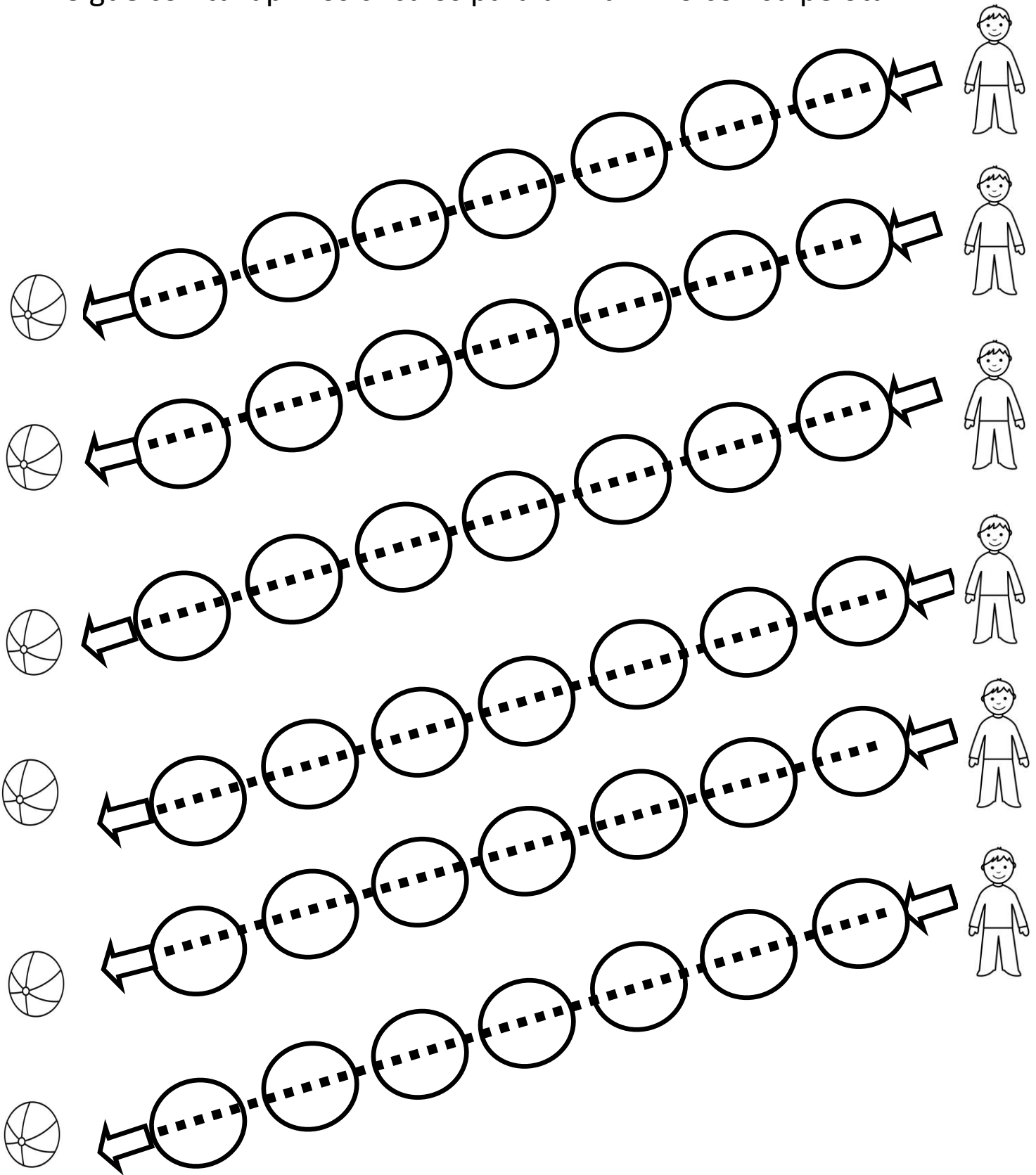

Actividades para mejorar motricidad fina

Sigue con tu lápiz los círculos para unir al niño con su pelota

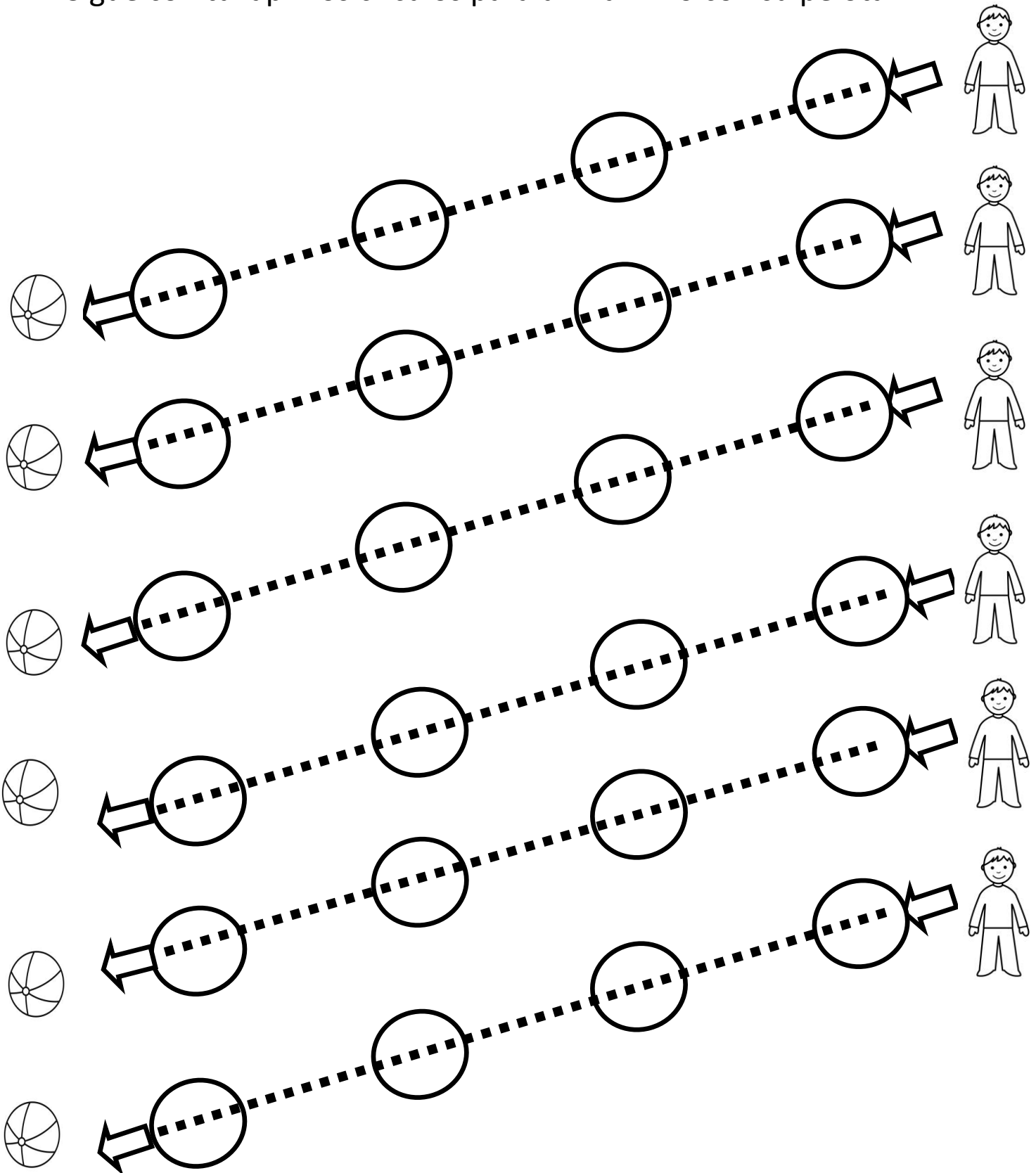

Actividades para mejorar motricidad fina

Sigue con tu lápiz los círculos para unir al niño con su pelota

The image shows a worksheet with seven rows of a zigzag path of circles. Each row starts with a ball on the left and ends with a boy on the right. The path consists of circles connected by small squares, with arrows indicating the direction of the line. The path starts with a ball on the left and ends with a boy on the right.

Actividades para mejorar motricidad fina

Sigue con tu lápiz los círculos para unir al niño con su pelota

The worksheet contains eight rows of tracing exercises. Each row consists of a ball icon on the left, a large circle with a left-pointing arrow, a dashed line connecting to a second circle, another dashed line connecting to a third circle, and a fourth circle with a right-pointing arrow. To the right of each row is a stick figure icon of a child. The goal is to trace the dashed lines and connect the circles to match each child with their ball.

Actividades para mejorar motricidad fina

Sigue con tu lápiz los círculos para unir al niño con su pelota

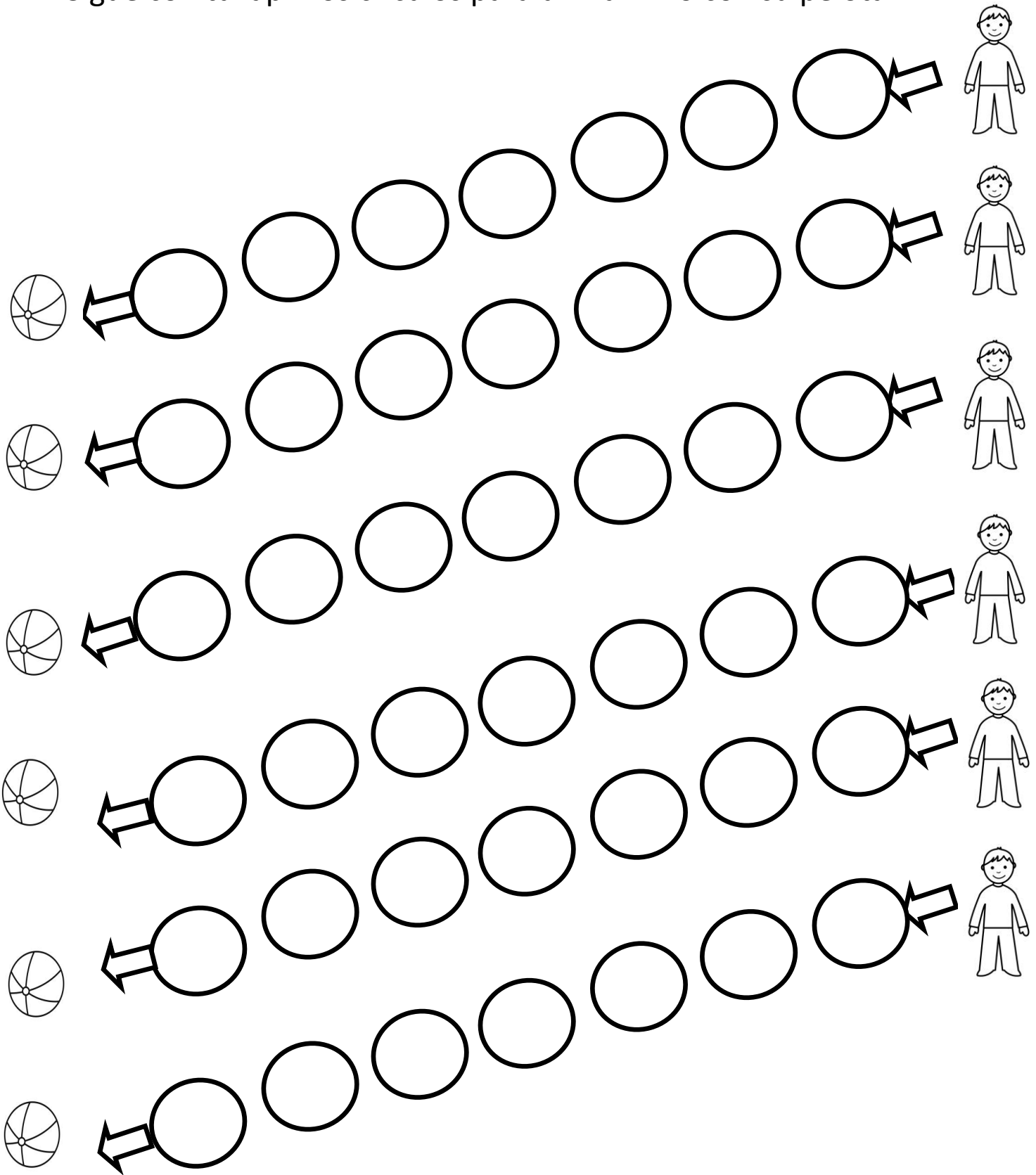

Actividades para mejorar motricidad fina

Sigue con tu lápiz los círculos para unir al niño con su pelota

Actividades para mejorar motricidad fina

Sigue con tu lápiz los cuadrados para unir a la niña con su casa

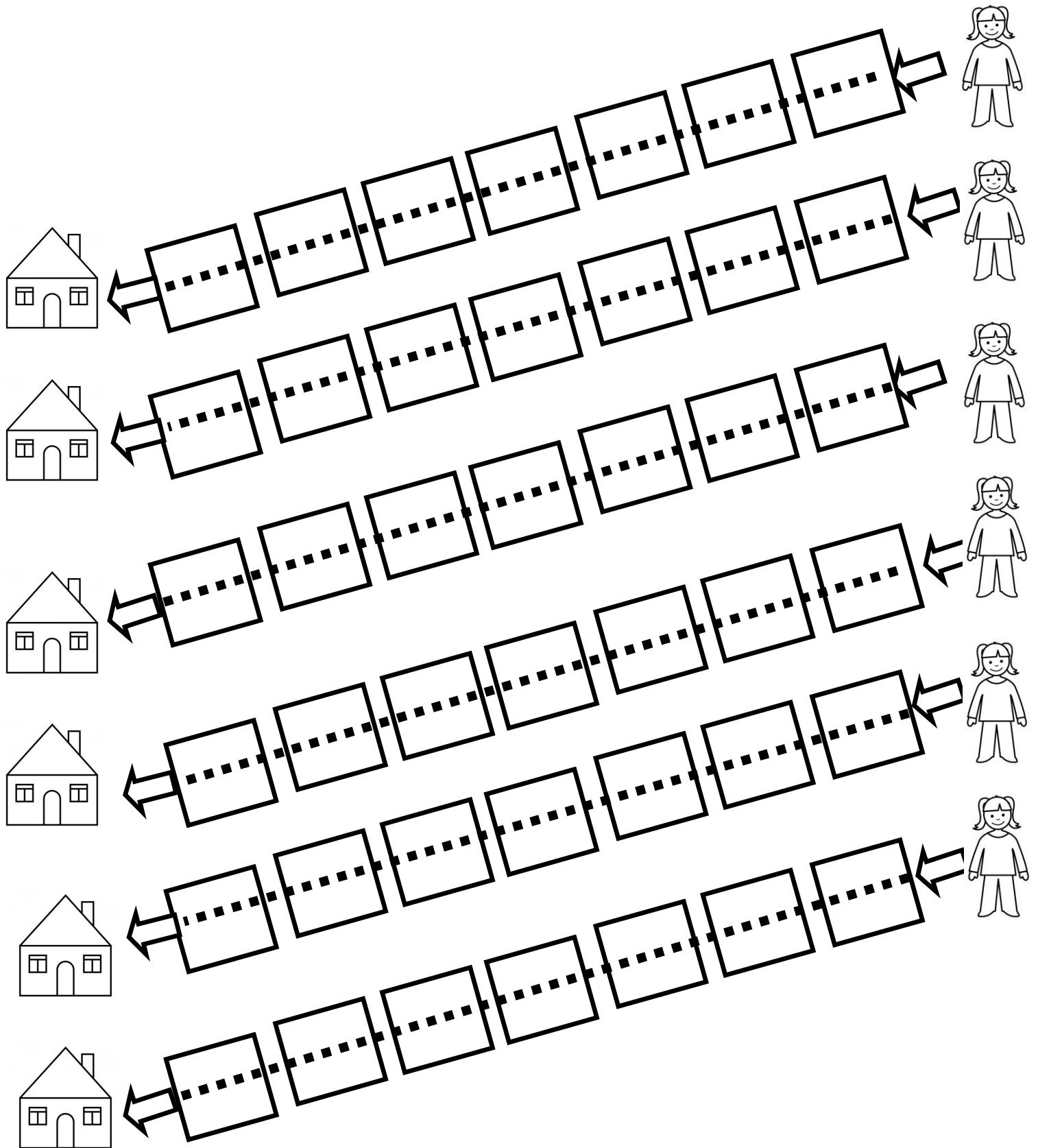

Actividades para mejorar motricidad fina

Sigue con tu lápiz los cuadrados para unir a la niña con su casa

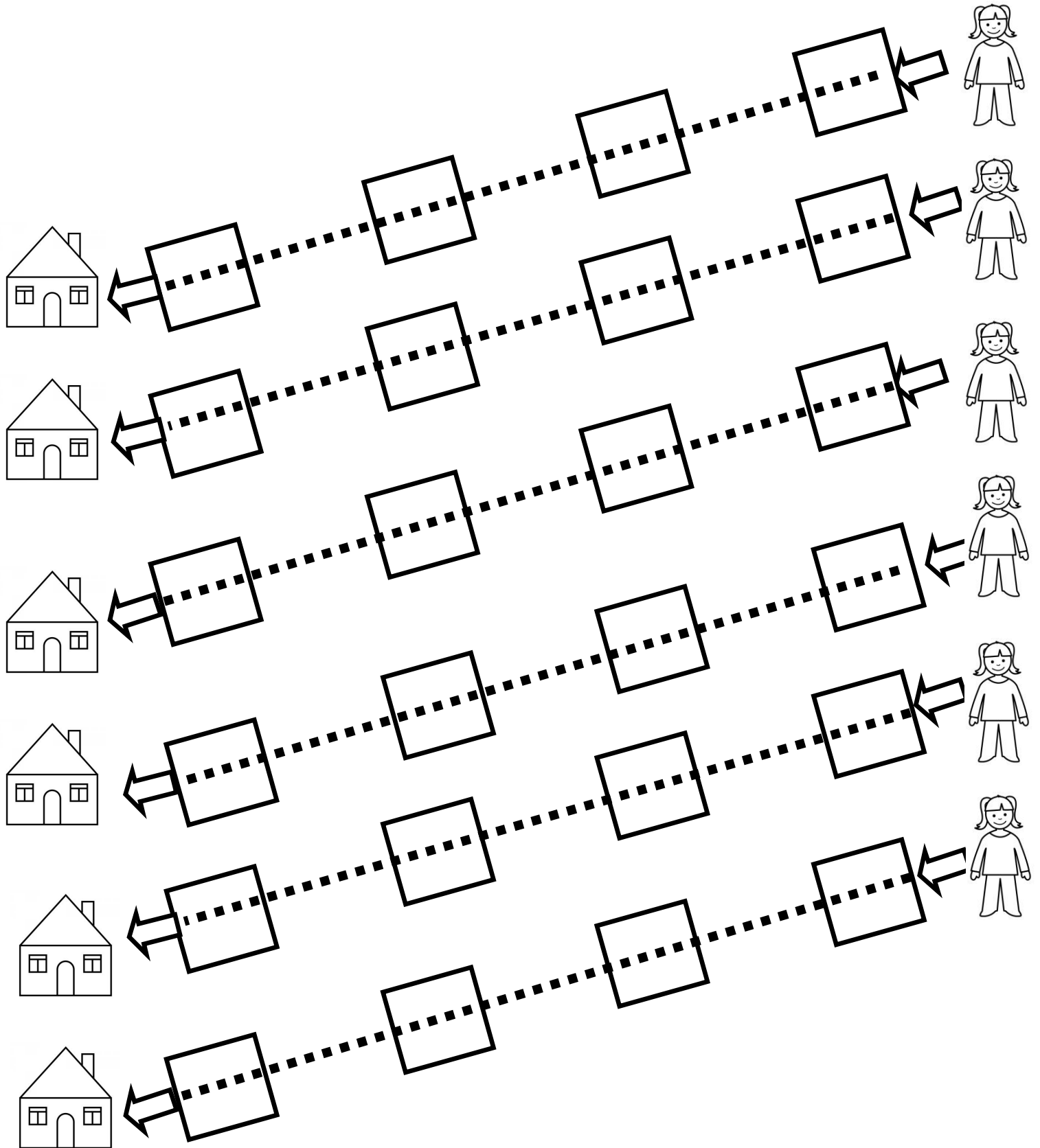

Actividades para mejorar motricidad fina

Sigue con tu lápiz los cuadrados para unir a la niña con su casa

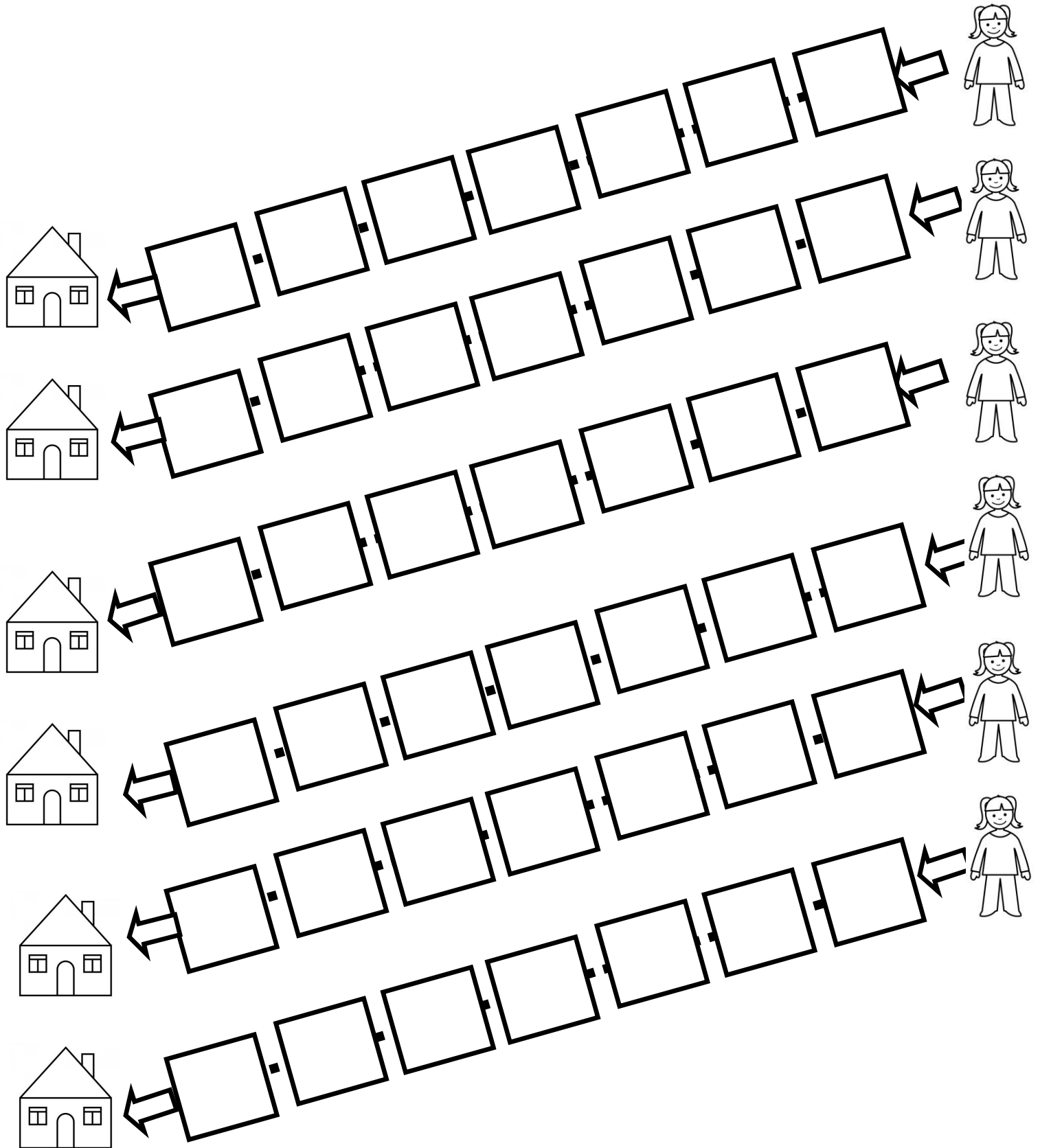

Actividades para mejorar motricidad fina

Sigue con tu lápiz los cuadrados para unir a la niña con su casa

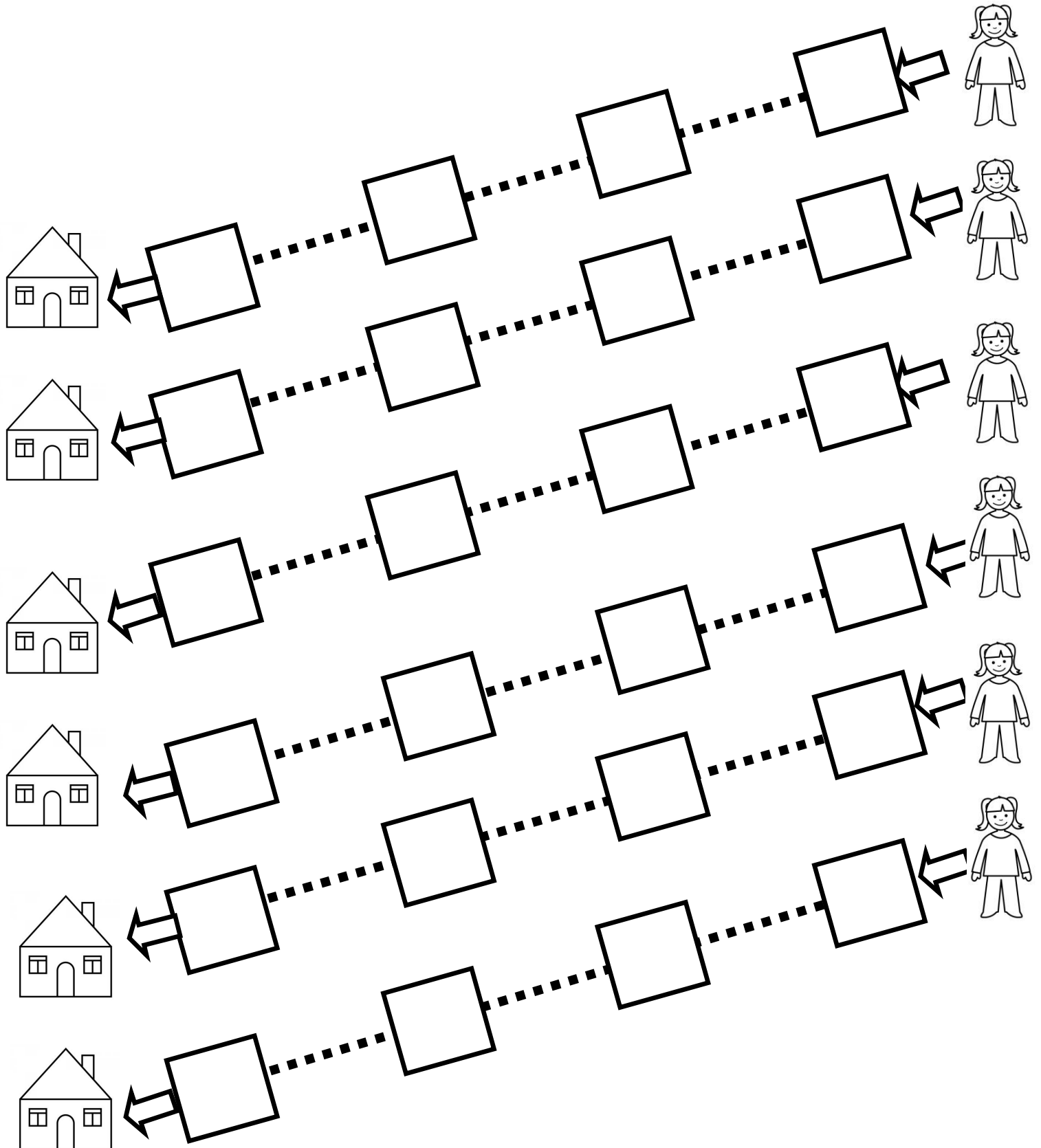

Actividades para mejorar motricidad fina

Sigue con tu lápiz los cuadrados para unir a la niña con su casa

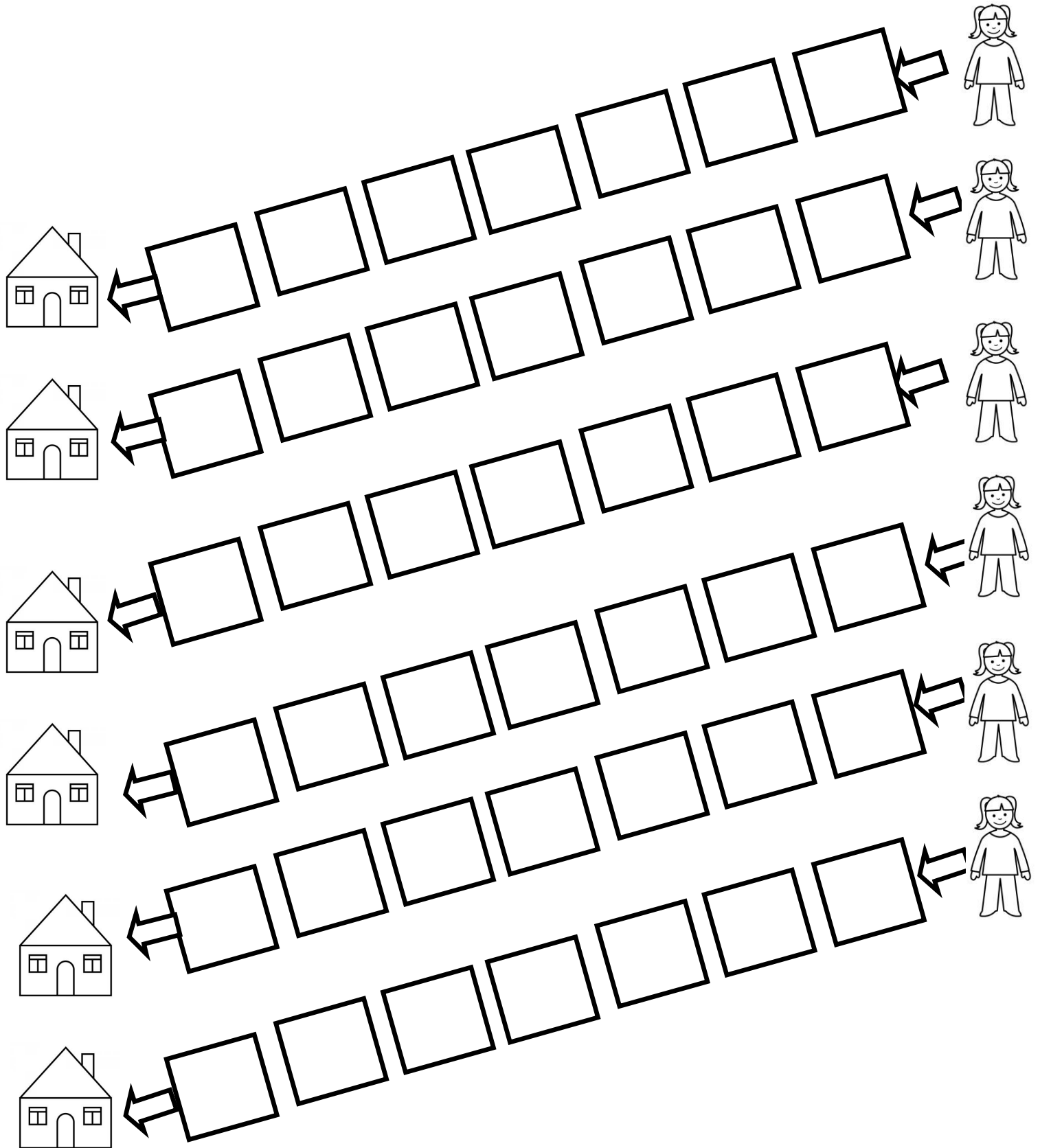

Actividades para mejorar motricidad fina

Sigue con tu lápiz los cuadrados para unir a la niña con su casa

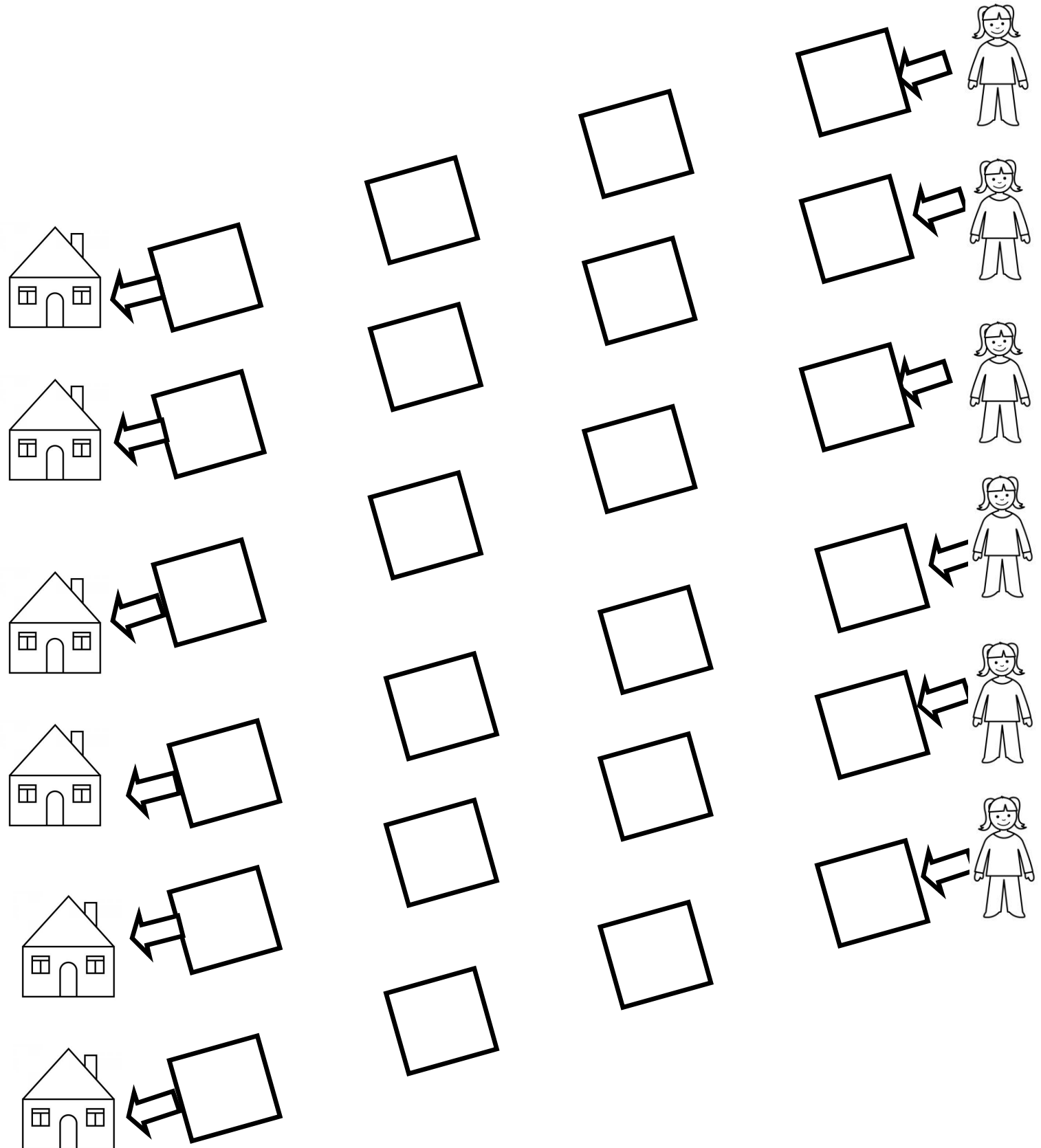

Actividades para mejorar motricidad fina

Sigue con tu lápiz los rayos para unir a nube y la tierra

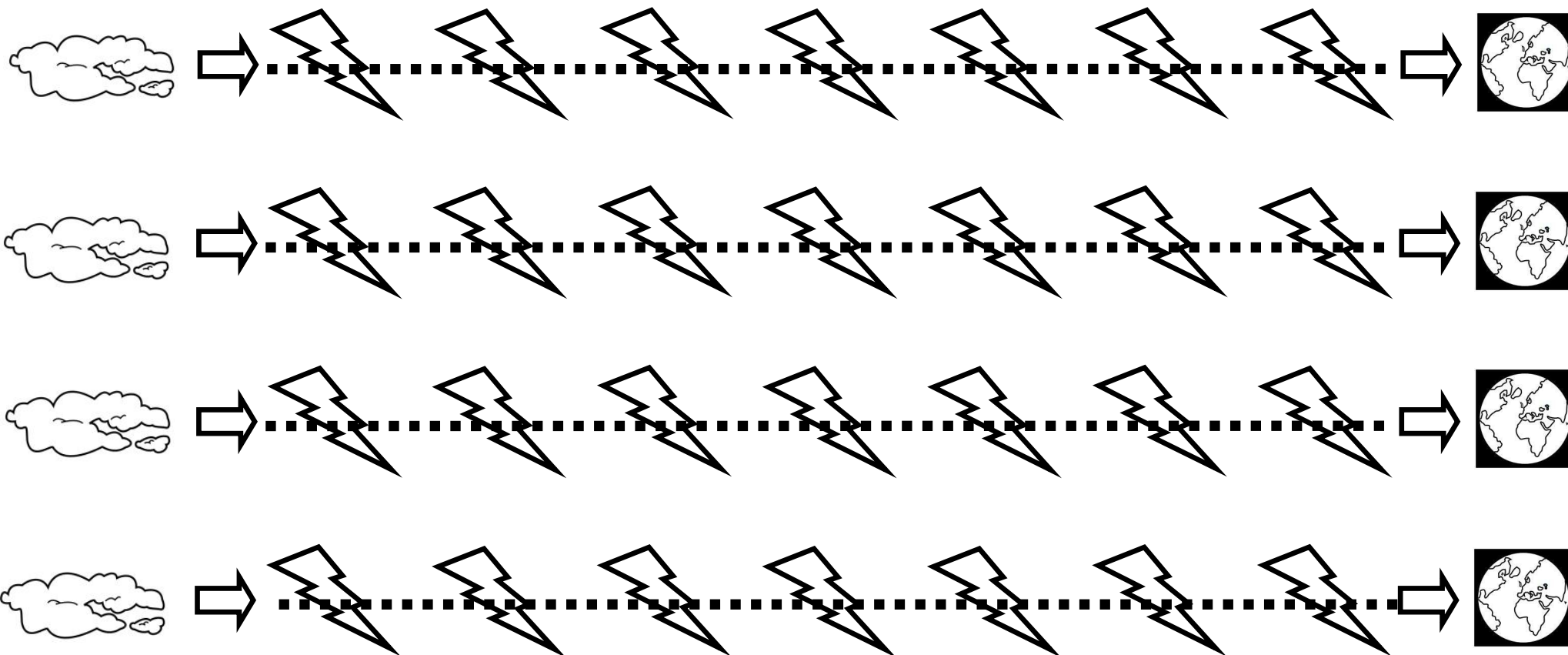

Actividades para mejorar motricidad fina

Sigue con tu lápiz los rayos para unir a nube y la tierra

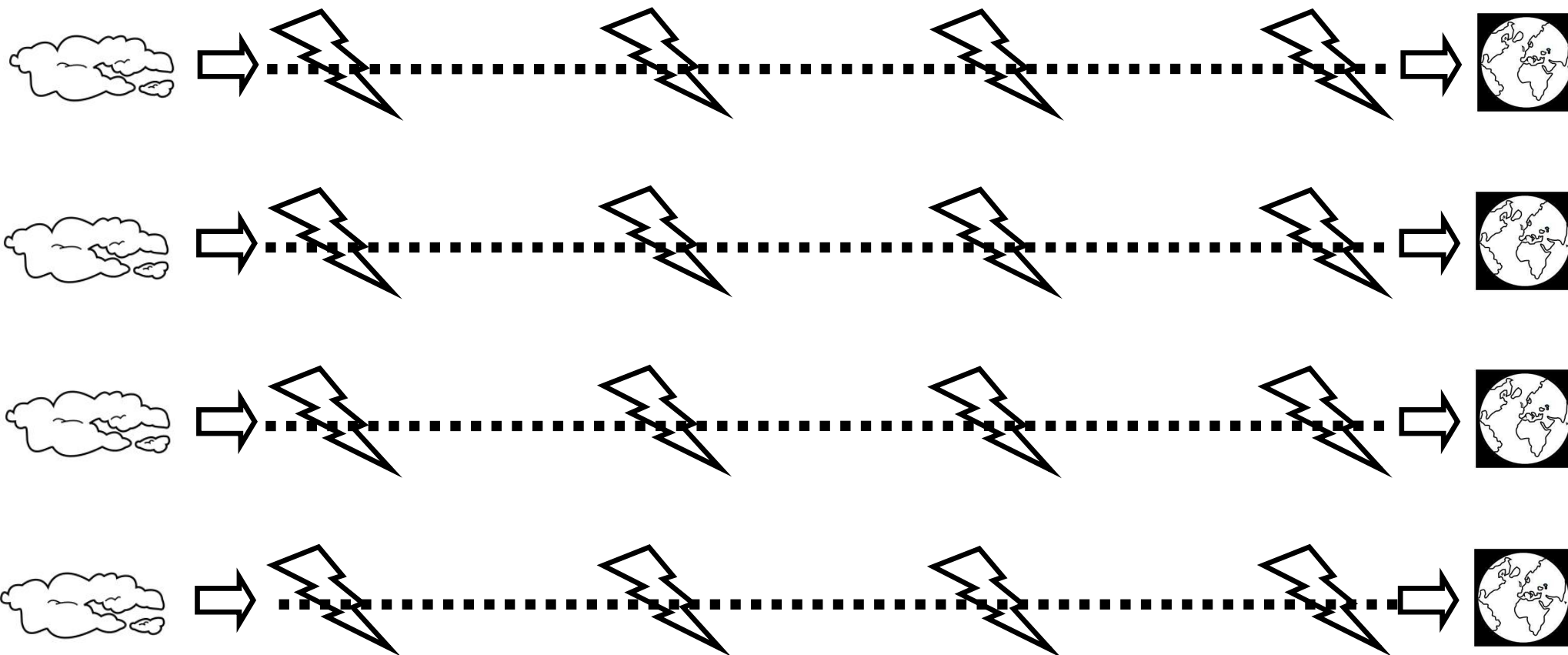

Actividades para mejorar motricidad fina

Sigue con tu lápiz los rayos para unir a nube y la tierra

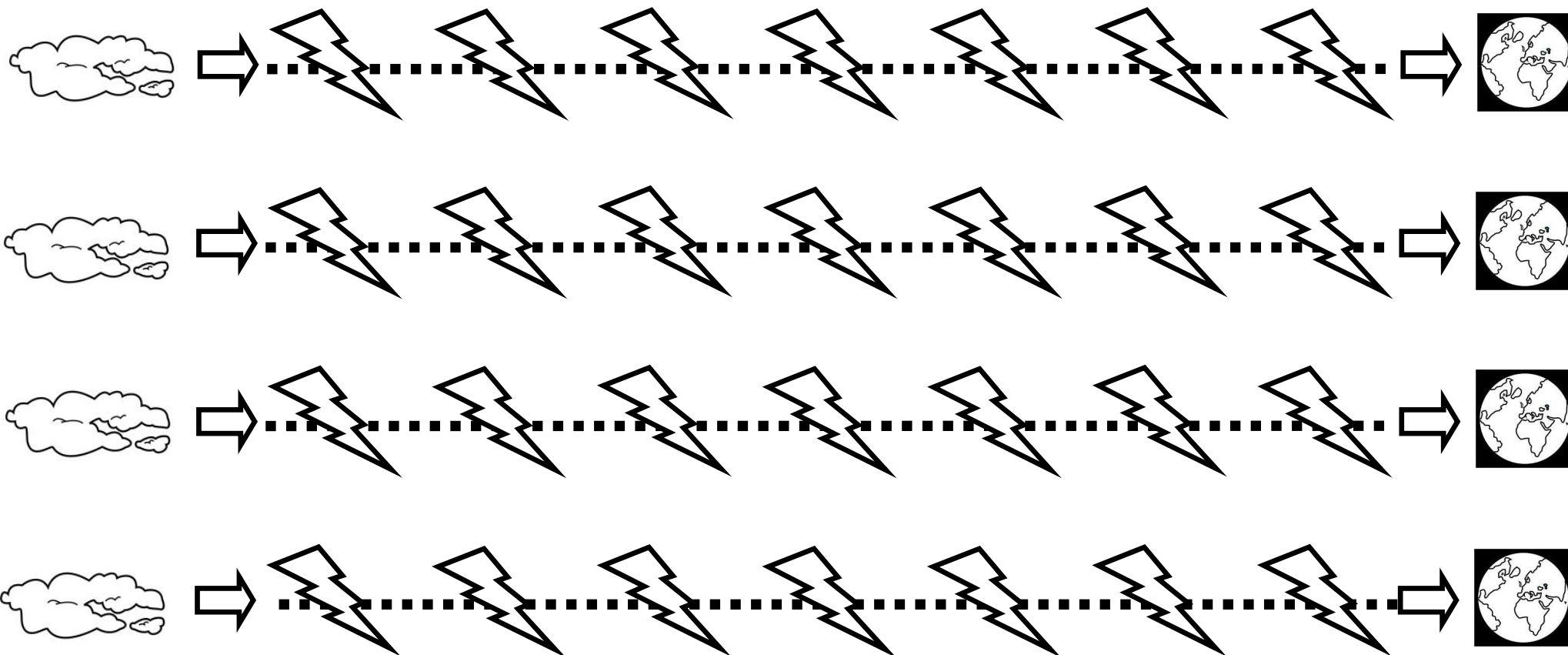

Actividades para mejorar motricidad fina

Sigue con tu lápiz los rayos para unir a nube y la tierra

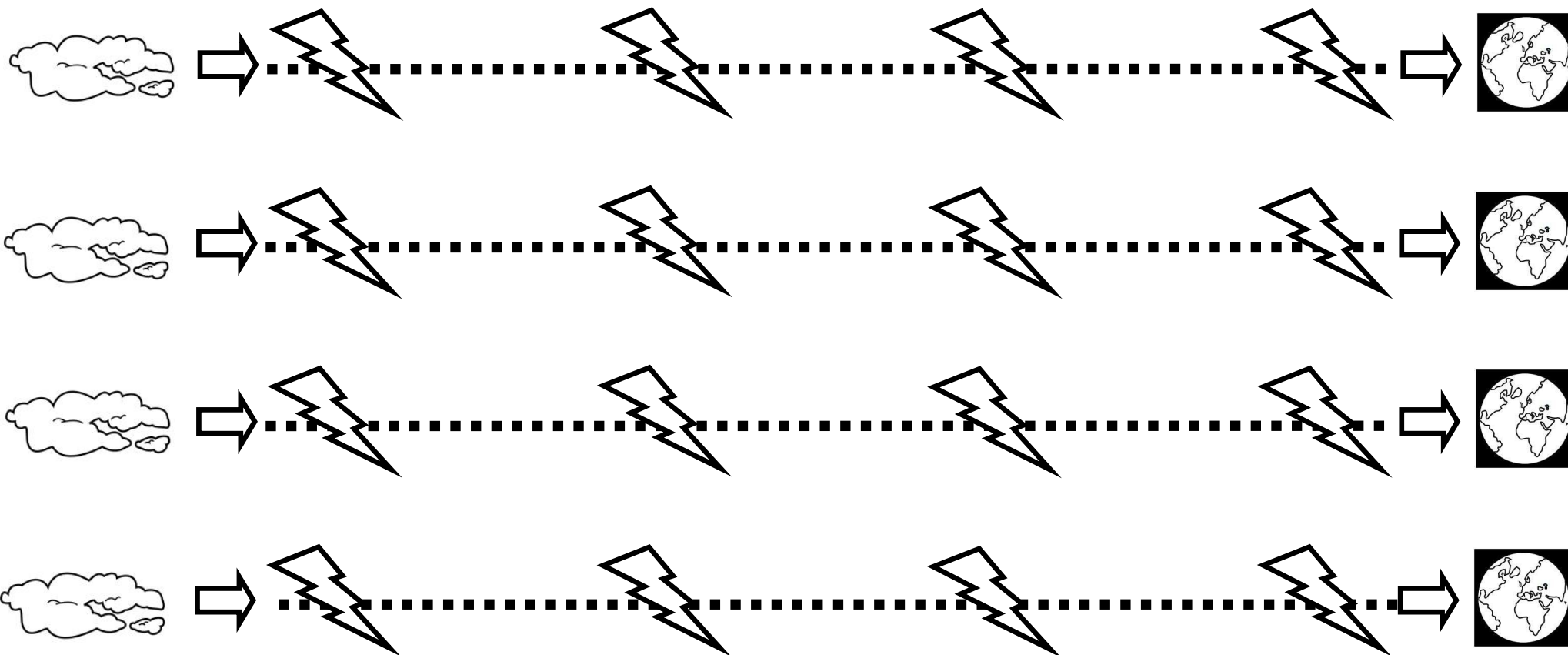

Actividades para mejorar motricidad fina

Sigue con tu lápiz los rayos para unir a nube y la tierra

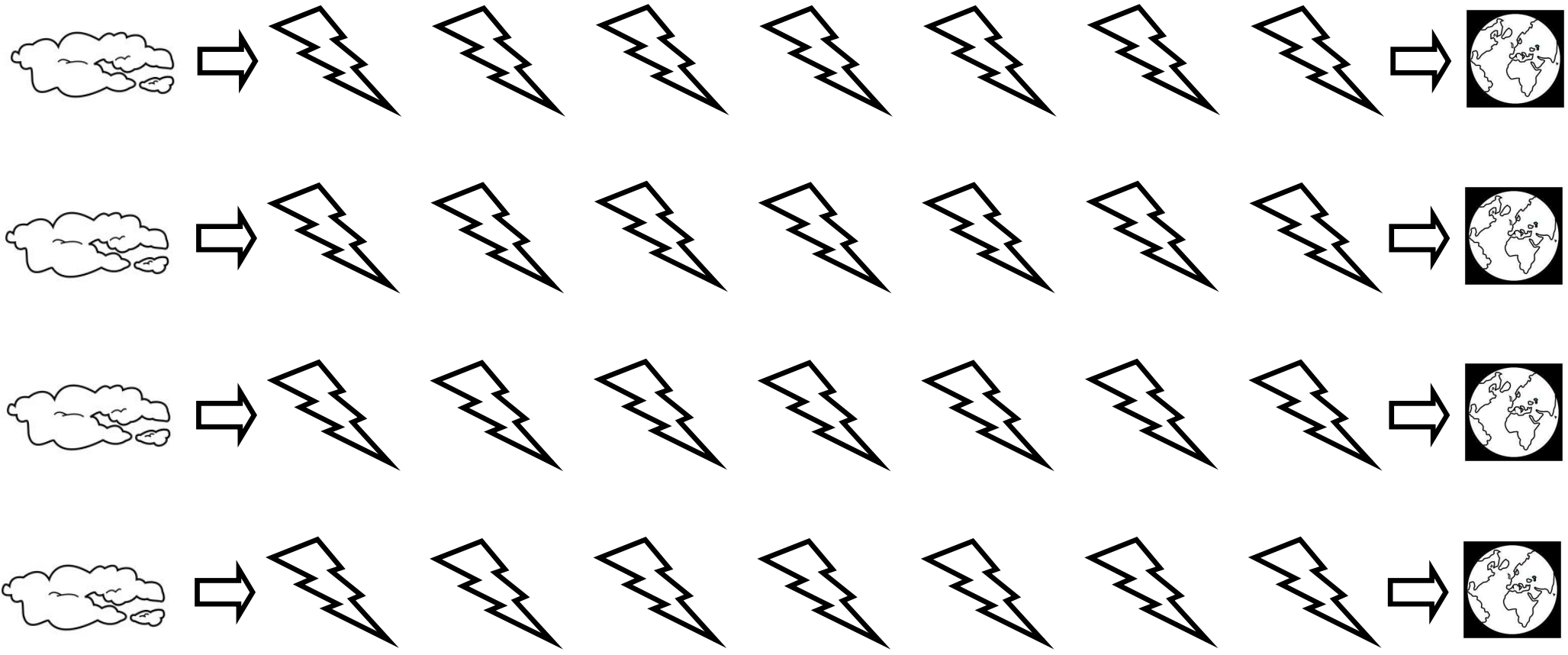

Actividades para mejorar motricidad fina

Sigue con tu lápiz los rayos para unir a nube y la tierra

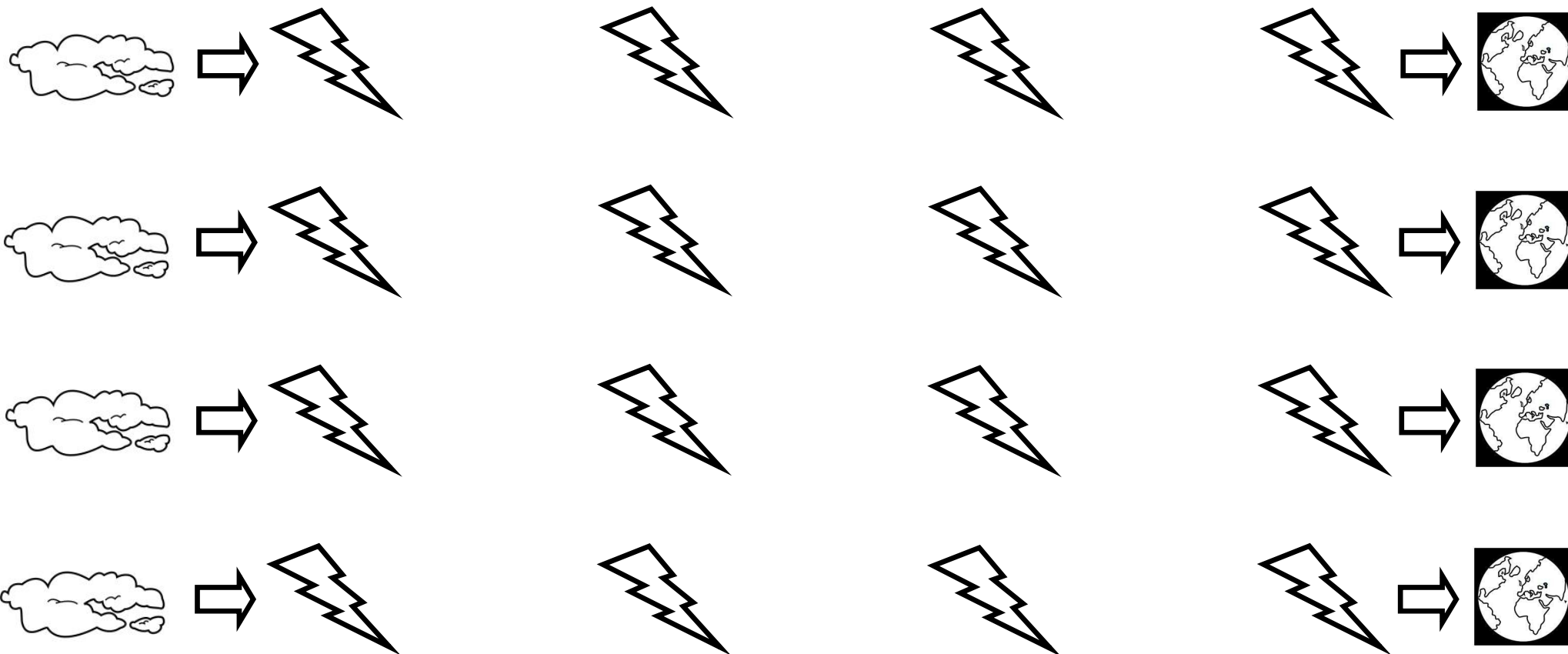

Actividades para mejorar motricidad fina

Sigue con tu lápiz las estrellitas para ir desde el sol a la tierra



Actividades para mejorar motricidad fina

Sigue con tu lápiz las estrellitas para ir desde el sol a la tierra



Actividades para mejorar motricidad fina

Sigue con tu lápiz las estrellitas para ir desde el sol a la tierra



Actividades para mejorar motricidad fina

Sigue con tu lápiz las estrellitas para ir desde el sol a la tierra

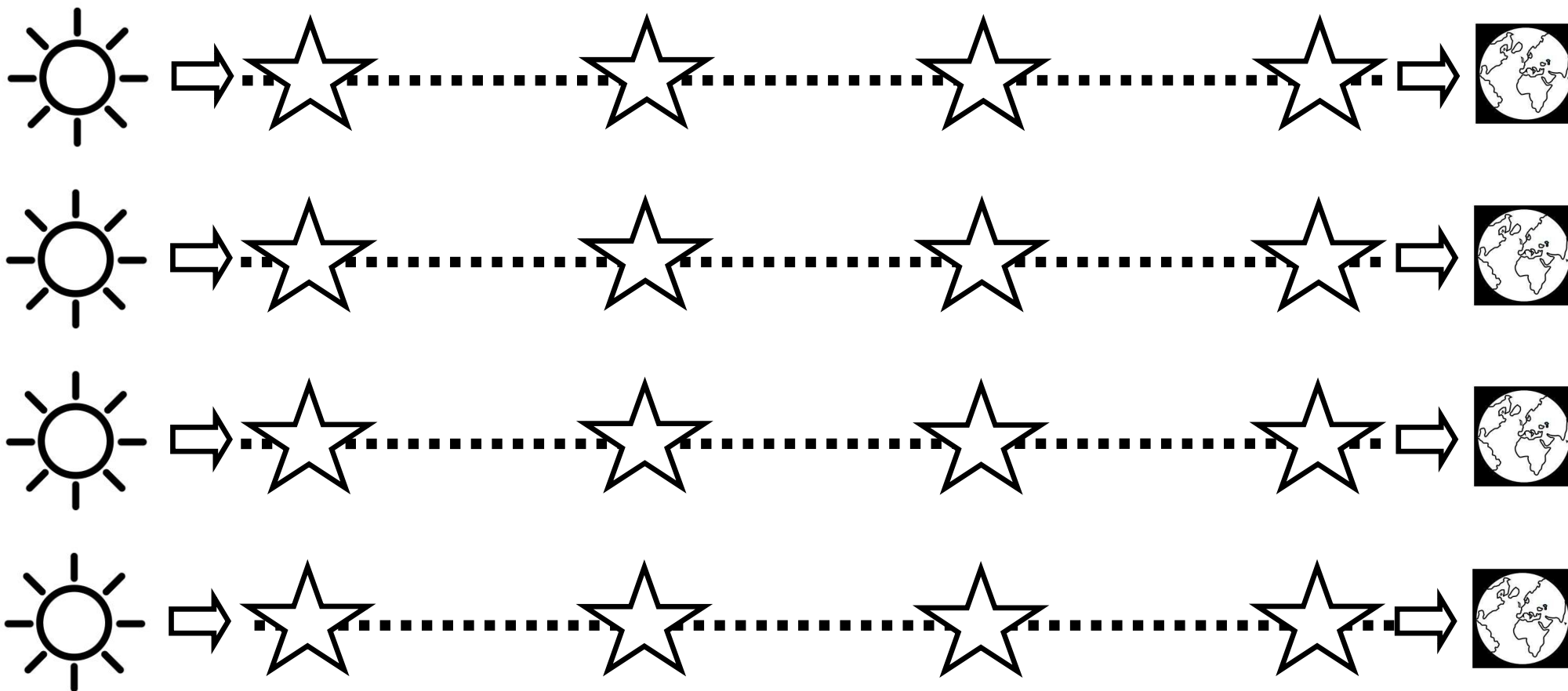

Actividades para mejorar motricidad fina

Sigue con tu lápiz las estrellitas para ir desde el sol a la tierra



Actividades para mejorar motricidad fina

Sigue con tu lápiz las estrellitas para ir desde el sol a la tierra

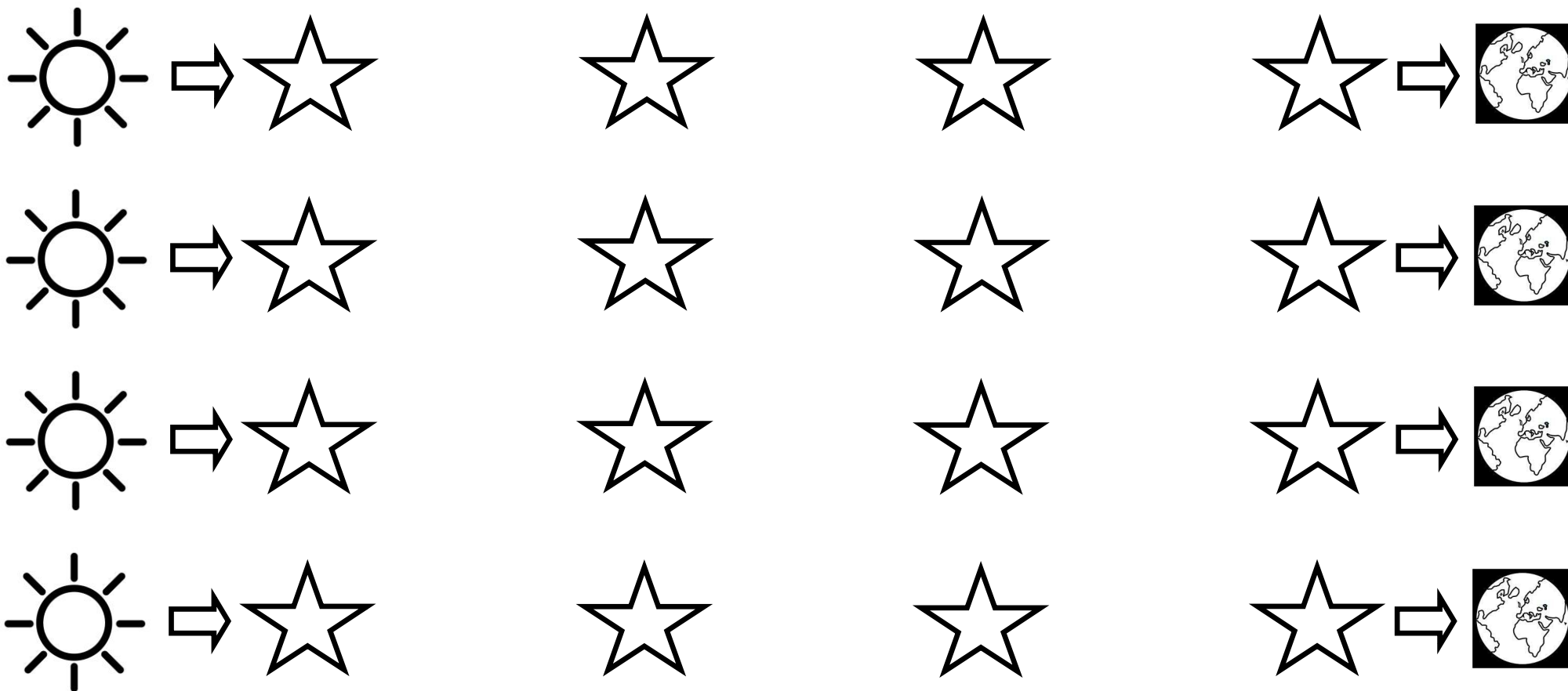

Actividades para mejorar motricidad fina

Sigue con tu lápiz los corazones para unir a la mama y a su bebe

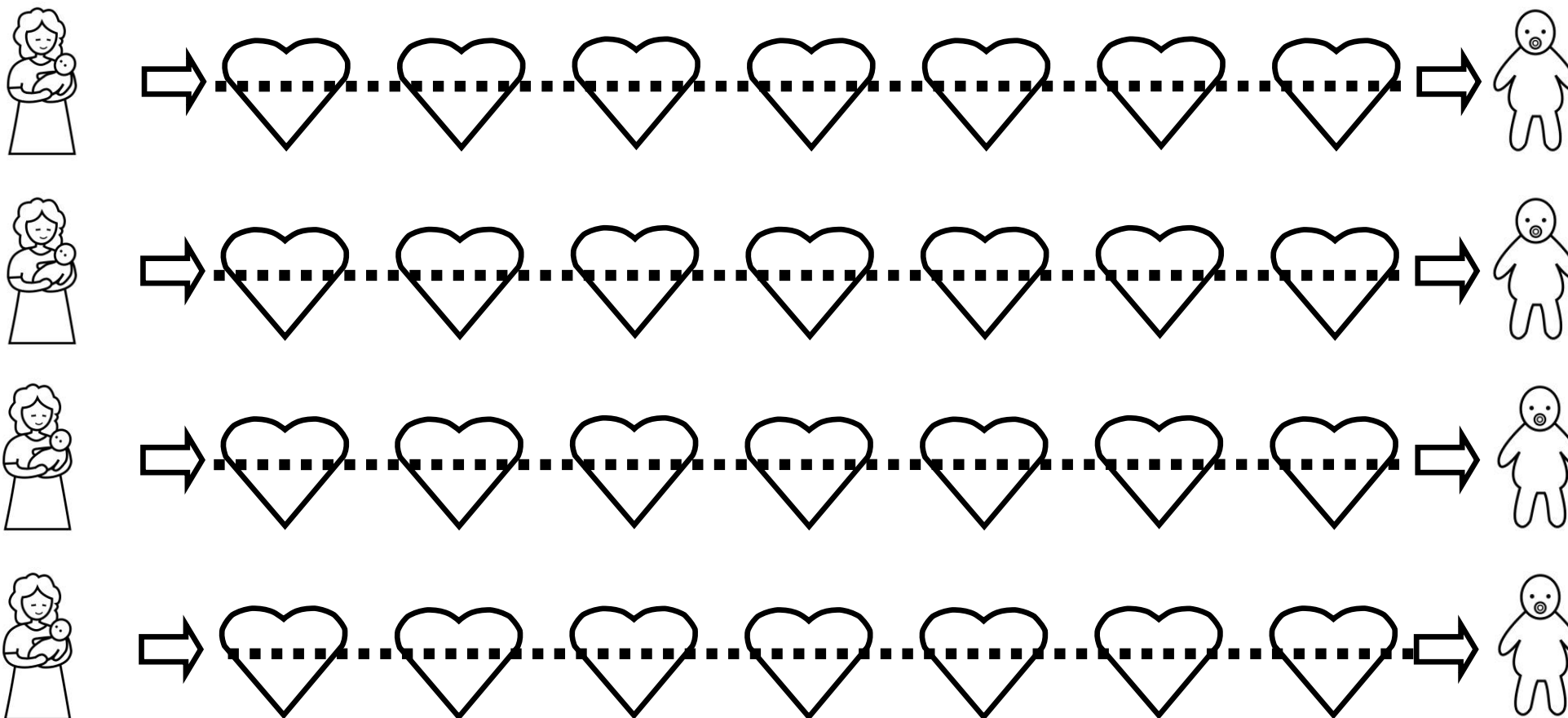

Actividades para mejorar motricidad fina

Sigue con tu lápiz los corazones para unir a la mama y a su bebe

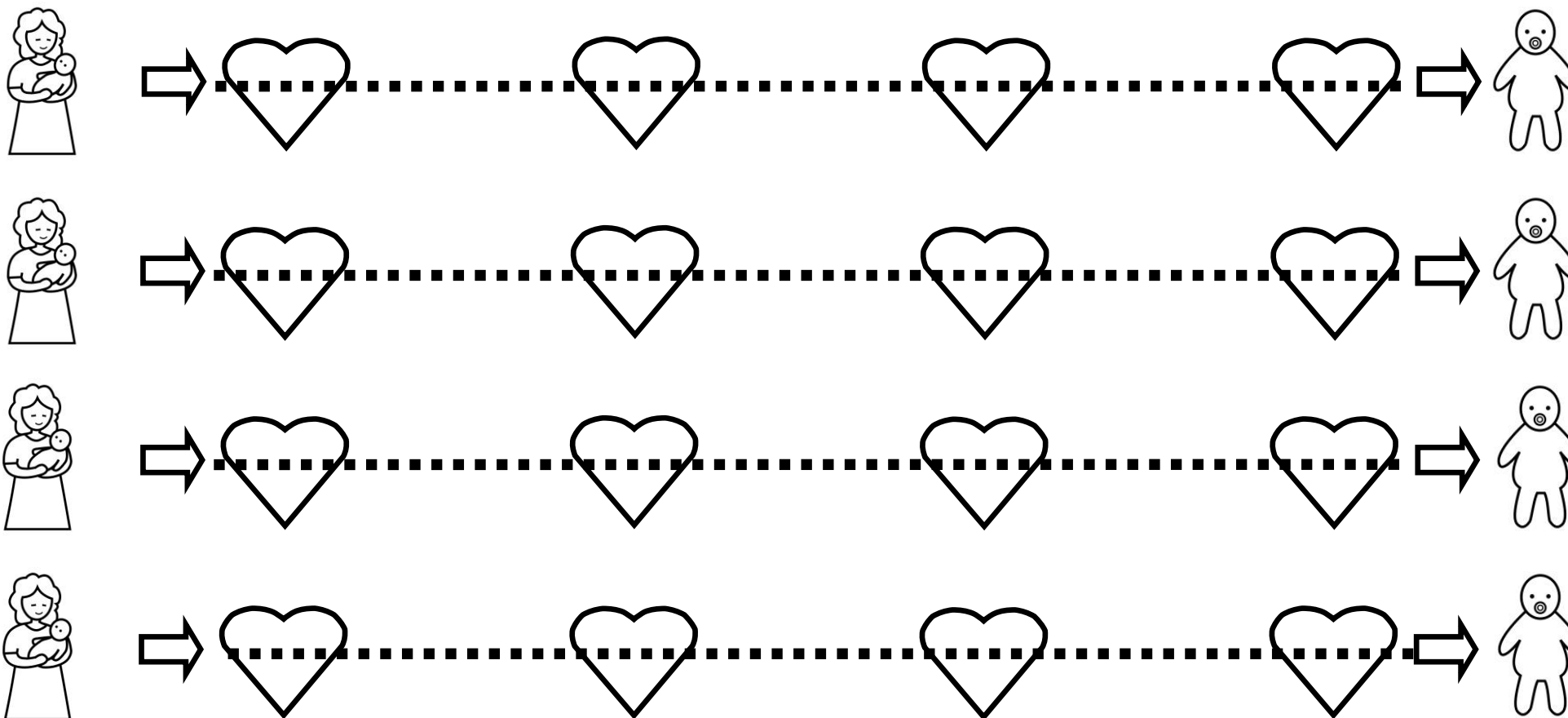

Actividades para mejorar motricidad fina

Sigue con tu lápiz los corazones para unir a la mama y a su bebe

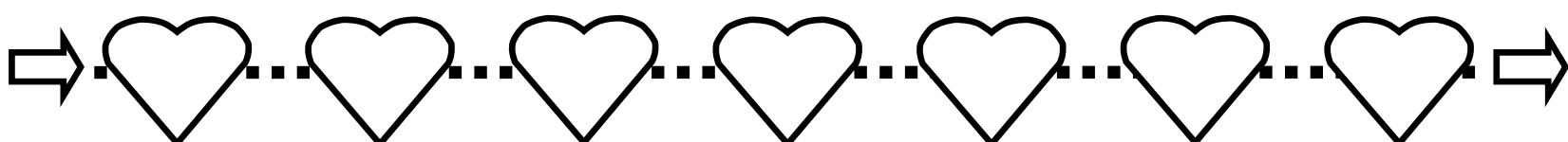
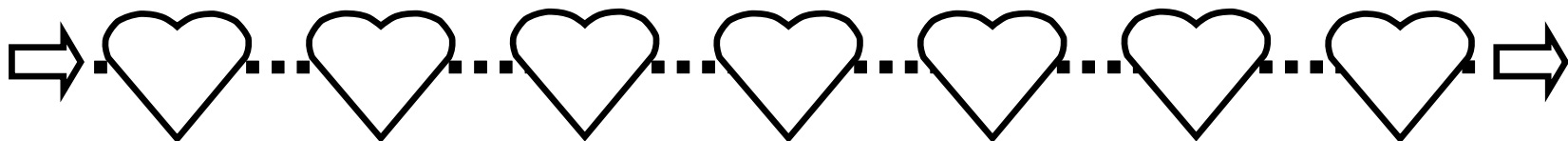
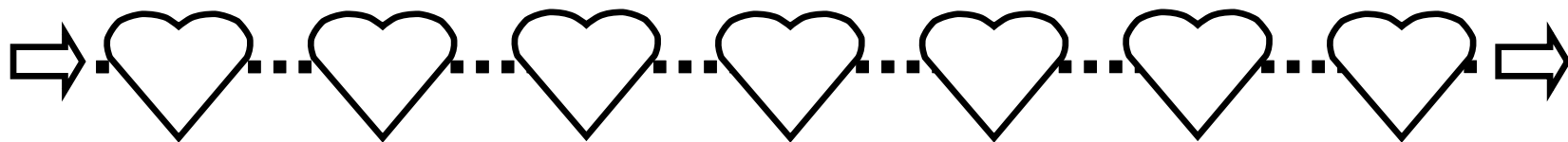

Actividades para mejorar motricidad fina

Sigue con tu lápiz los corazones para unir a la mama y a su bebe

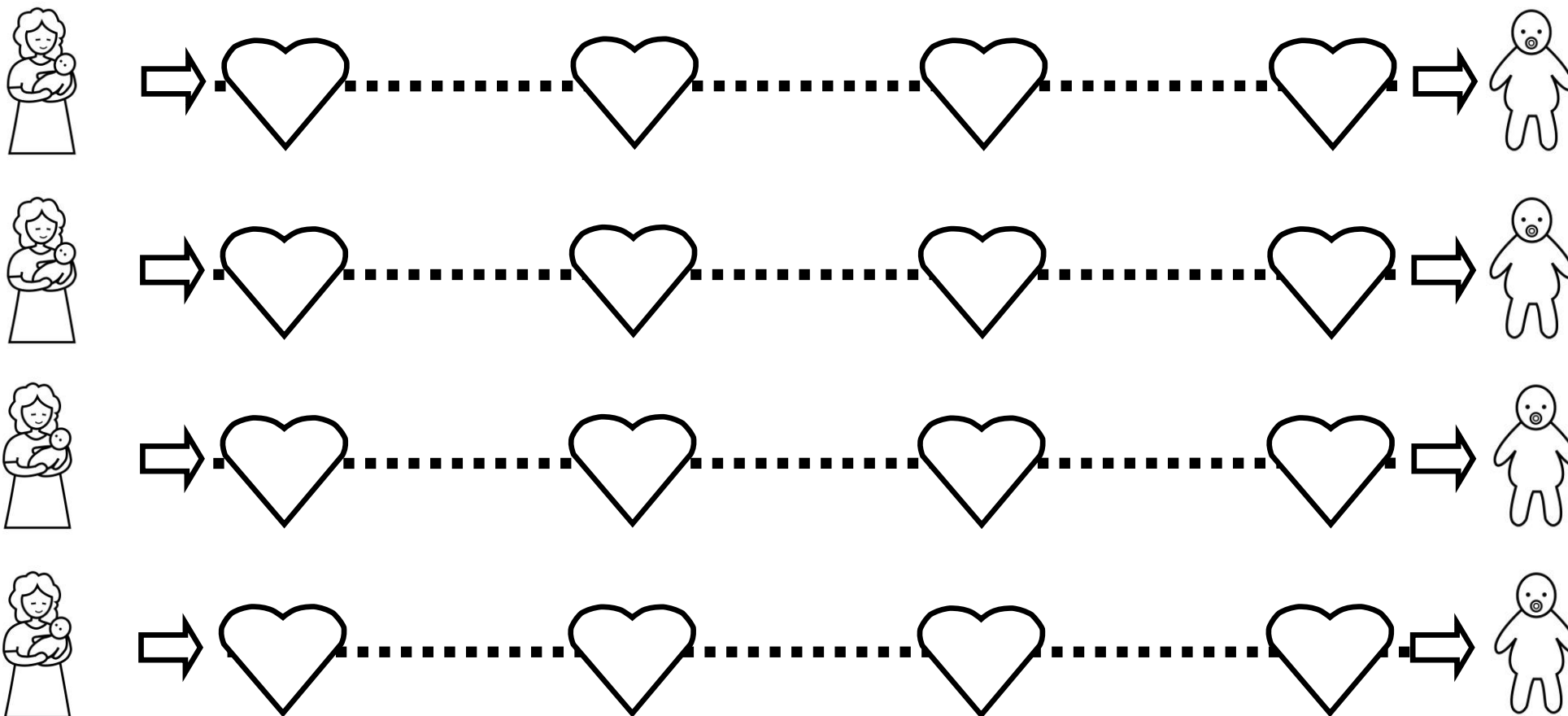

Actividades para mejorar motricidad fina

Sigue con tu lápiz los corazones para unir a la mama y a su bebe

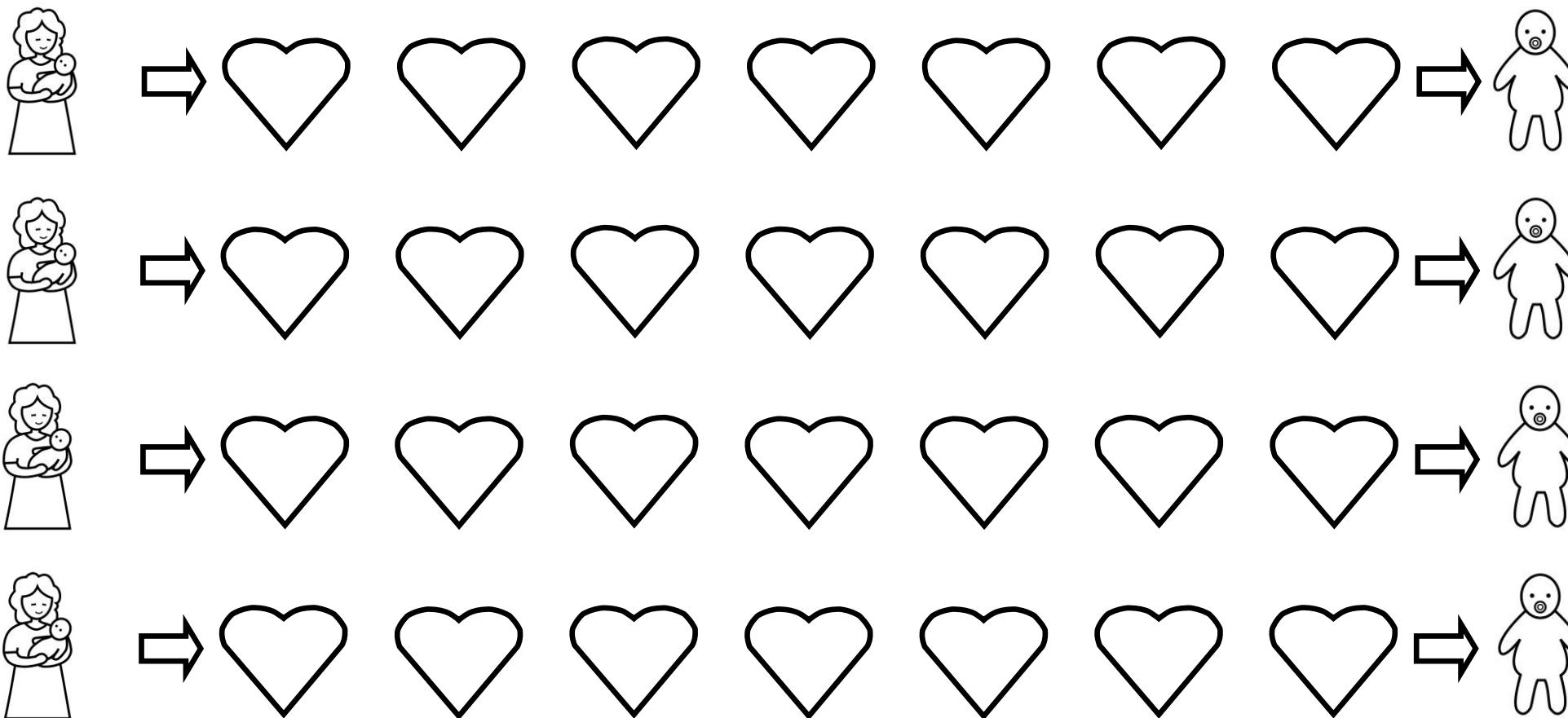

Actividades para mejorar motricidad fina

Sigue con tu lápiz los corazones para unir a la mama y a su bebe

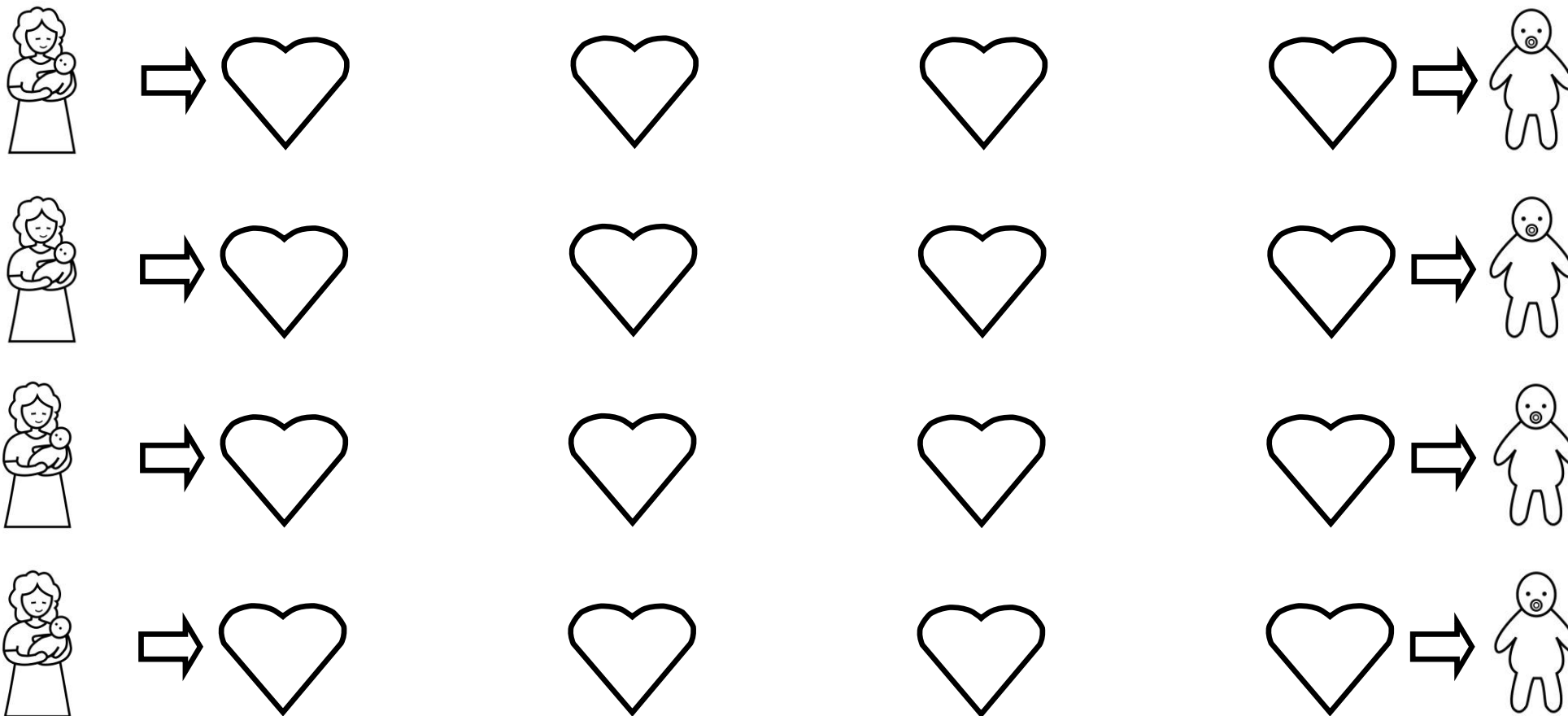

Actividades para mejorar motricidad fina

Sigue con tu lápiz las caras para unir al niño con su amiga

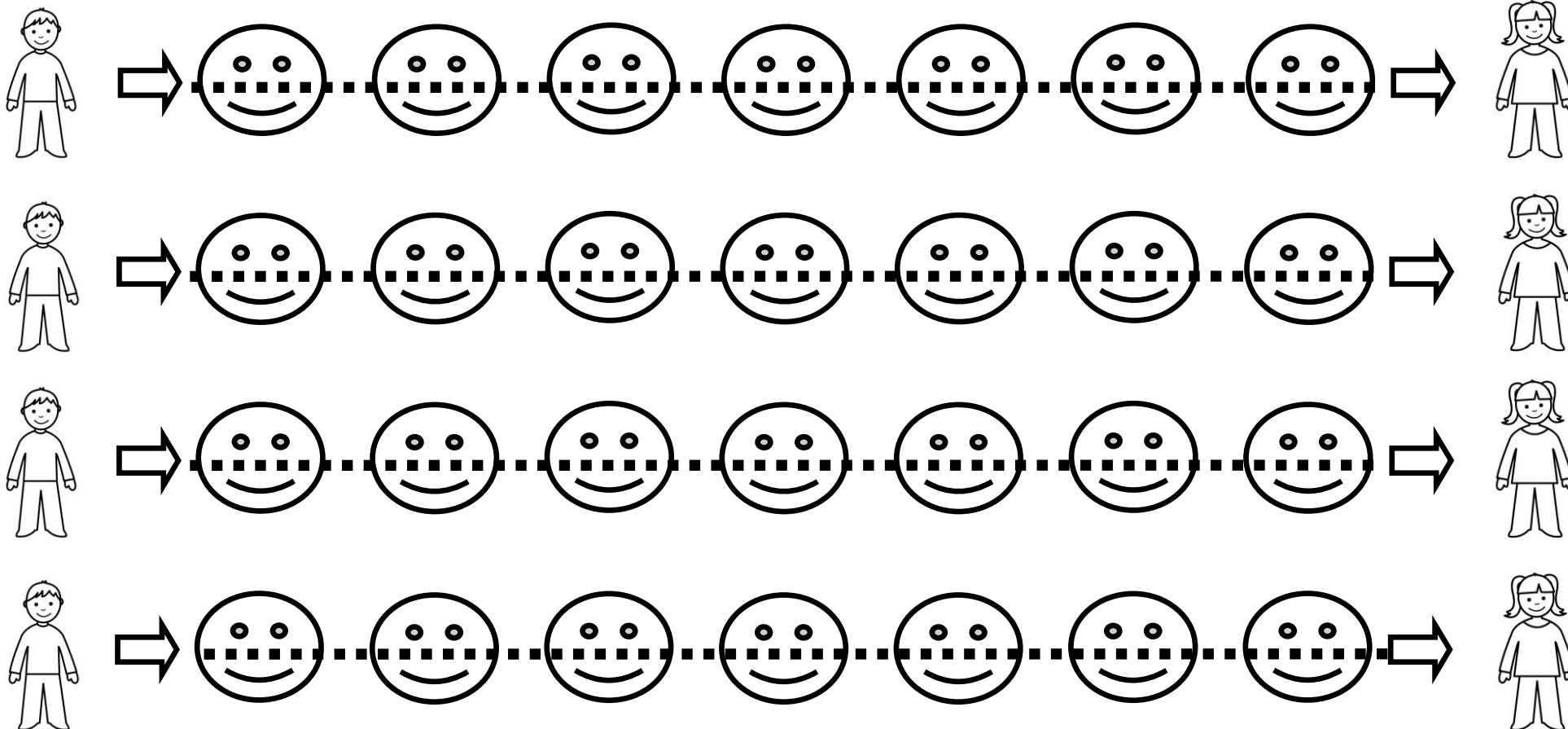

Actividades para mejorar motricidad fina

Sigue con tu lápiz las caras para unir al niño con su amiga

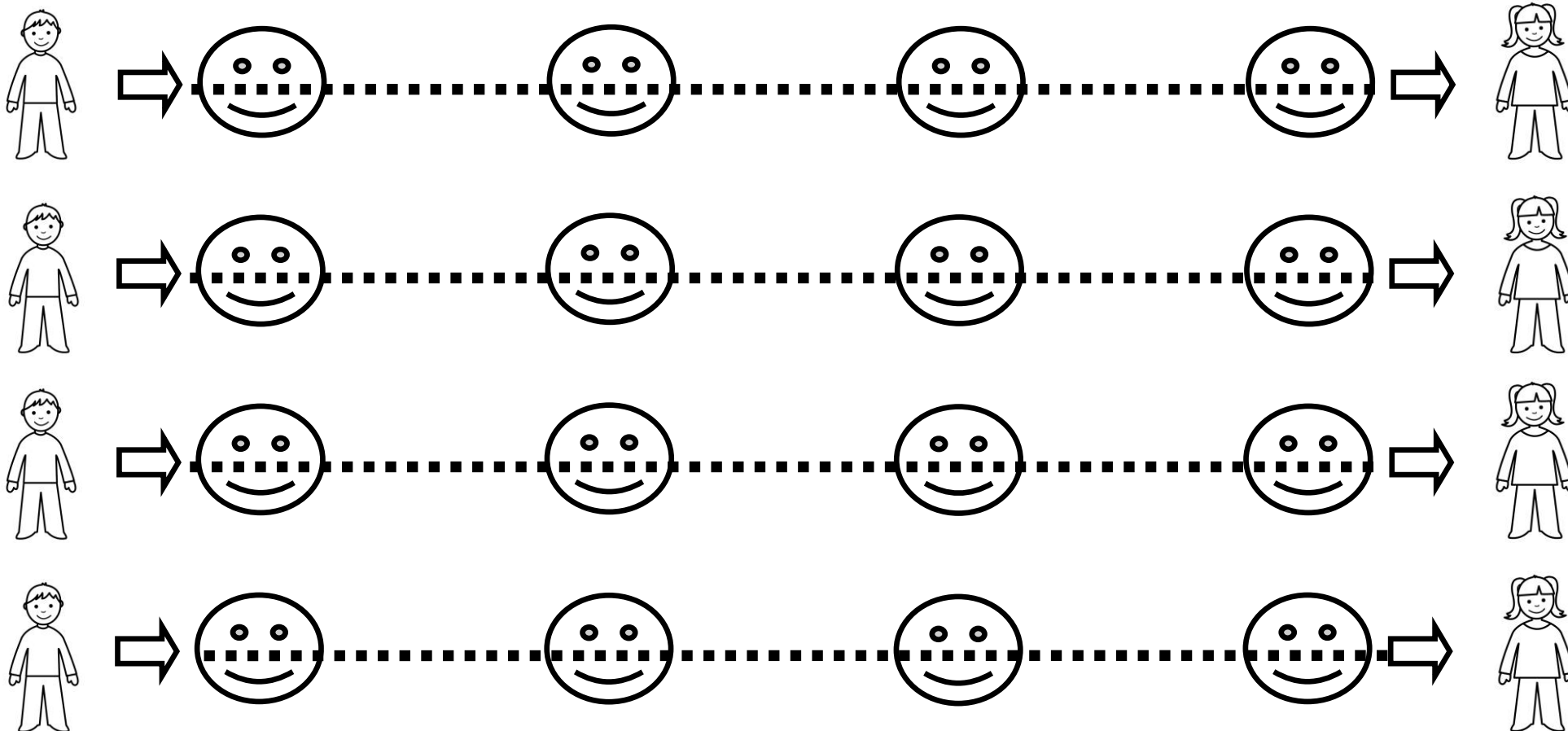

Actividades para mejorar motricidad fina

Sigue con tu lápiz las caras para unir al niño con su amiga

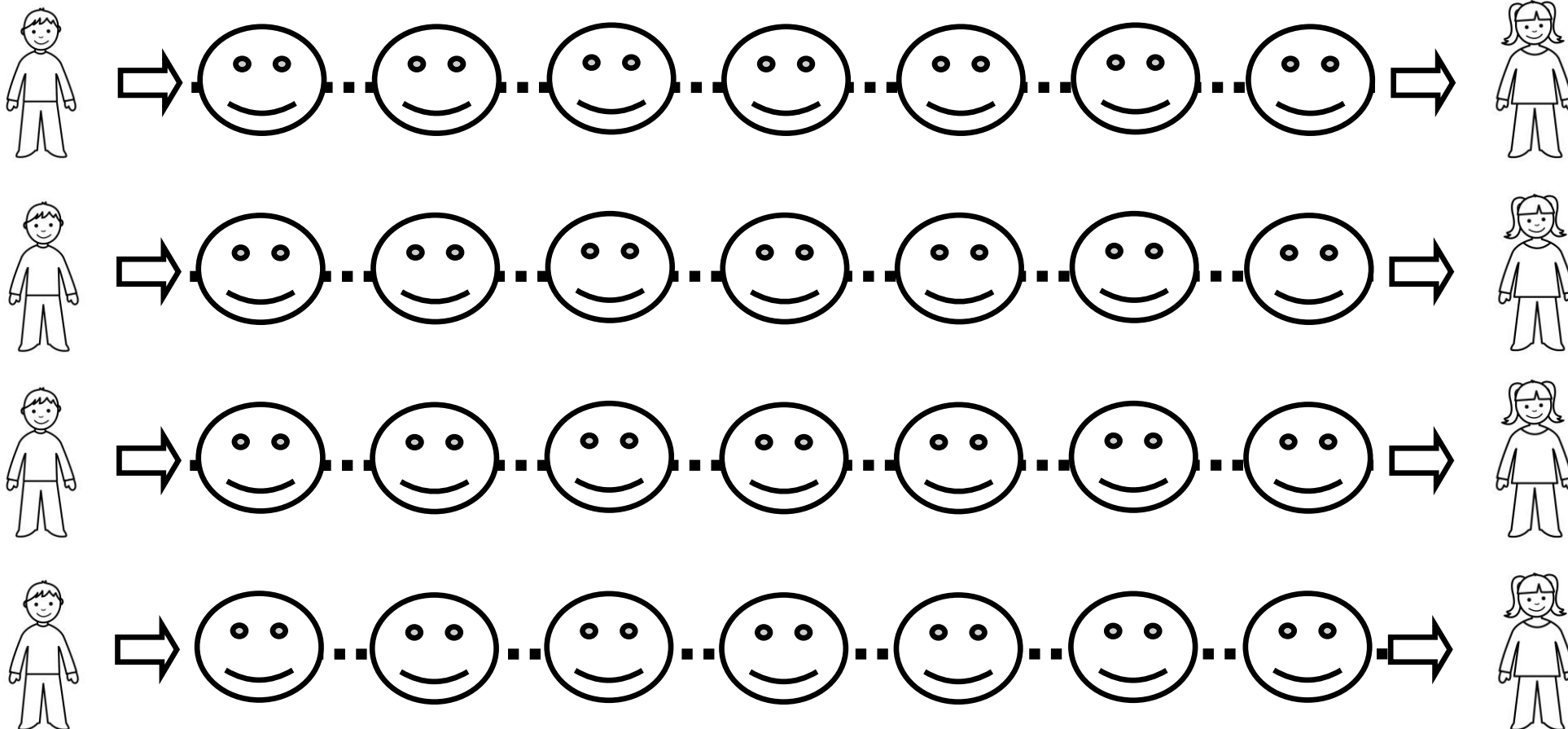

Actividades para mejorar motricidad fina

Sigue con tu lápiz las caras para unir al niño con su amiga

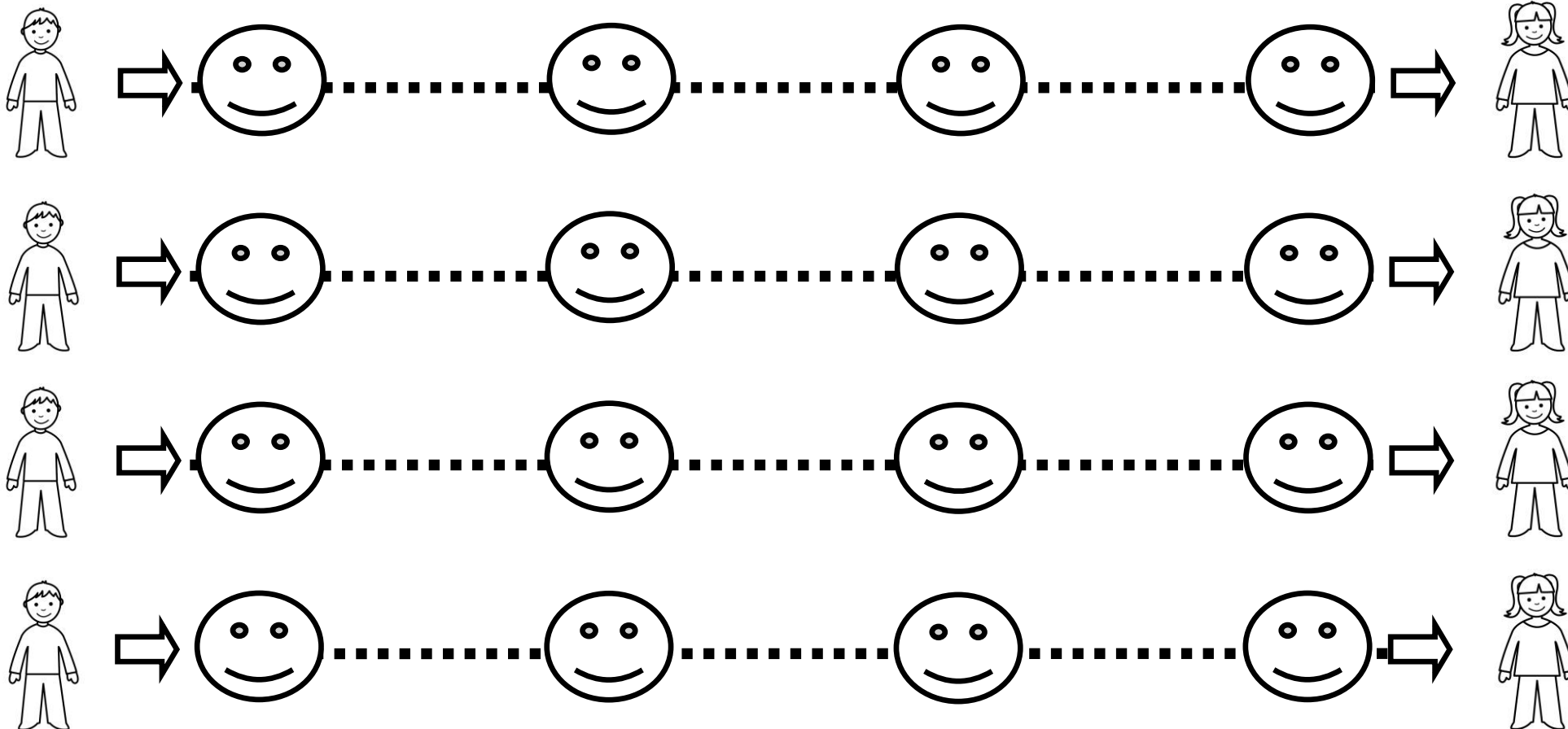

Actividades para mejorar motricidad fina

Sigue con tu lápiz las caras para unir al niño con su amiga

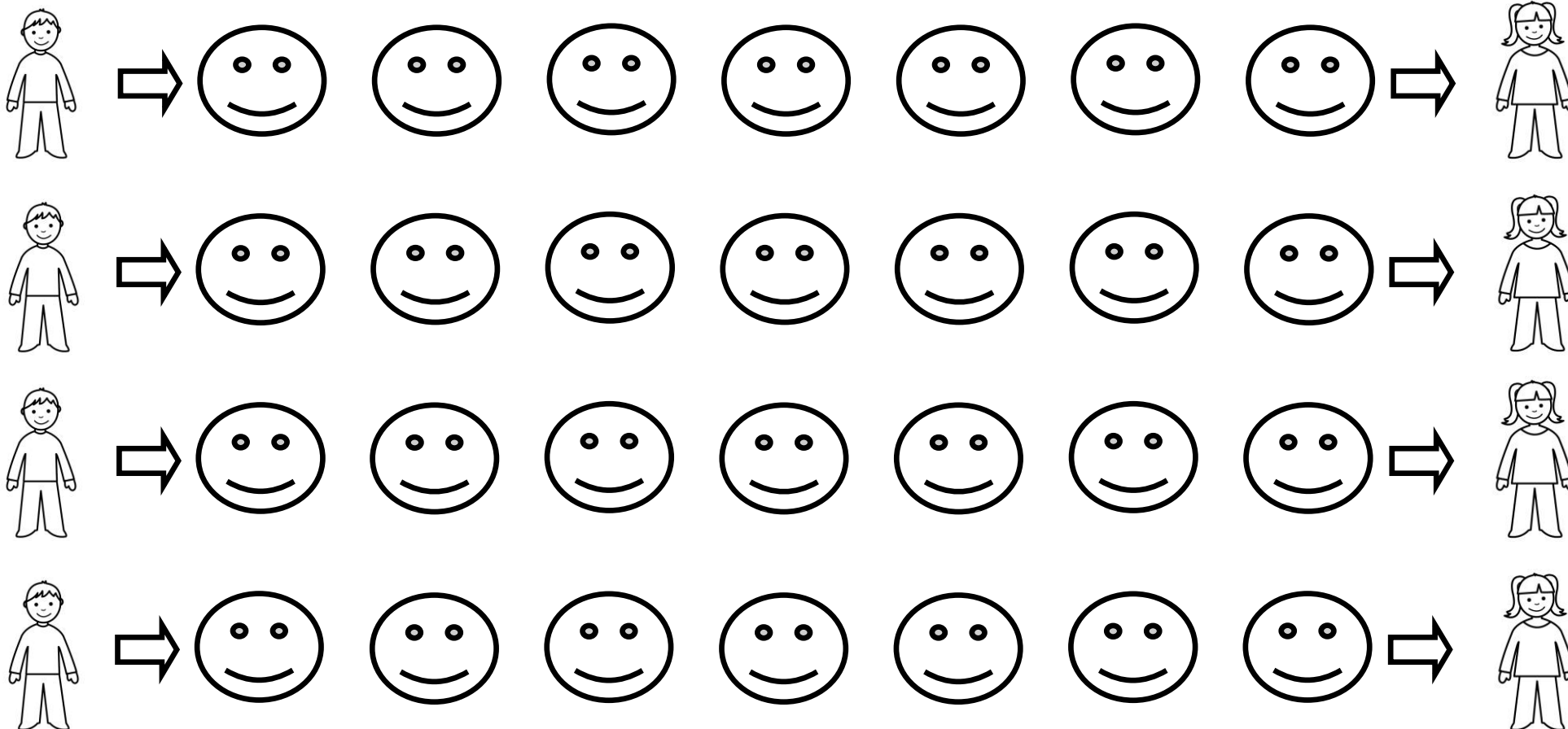

Actividades para mejorar motricidad fina

Sigue con tu lápiz las caras para unir al niño con su amiga

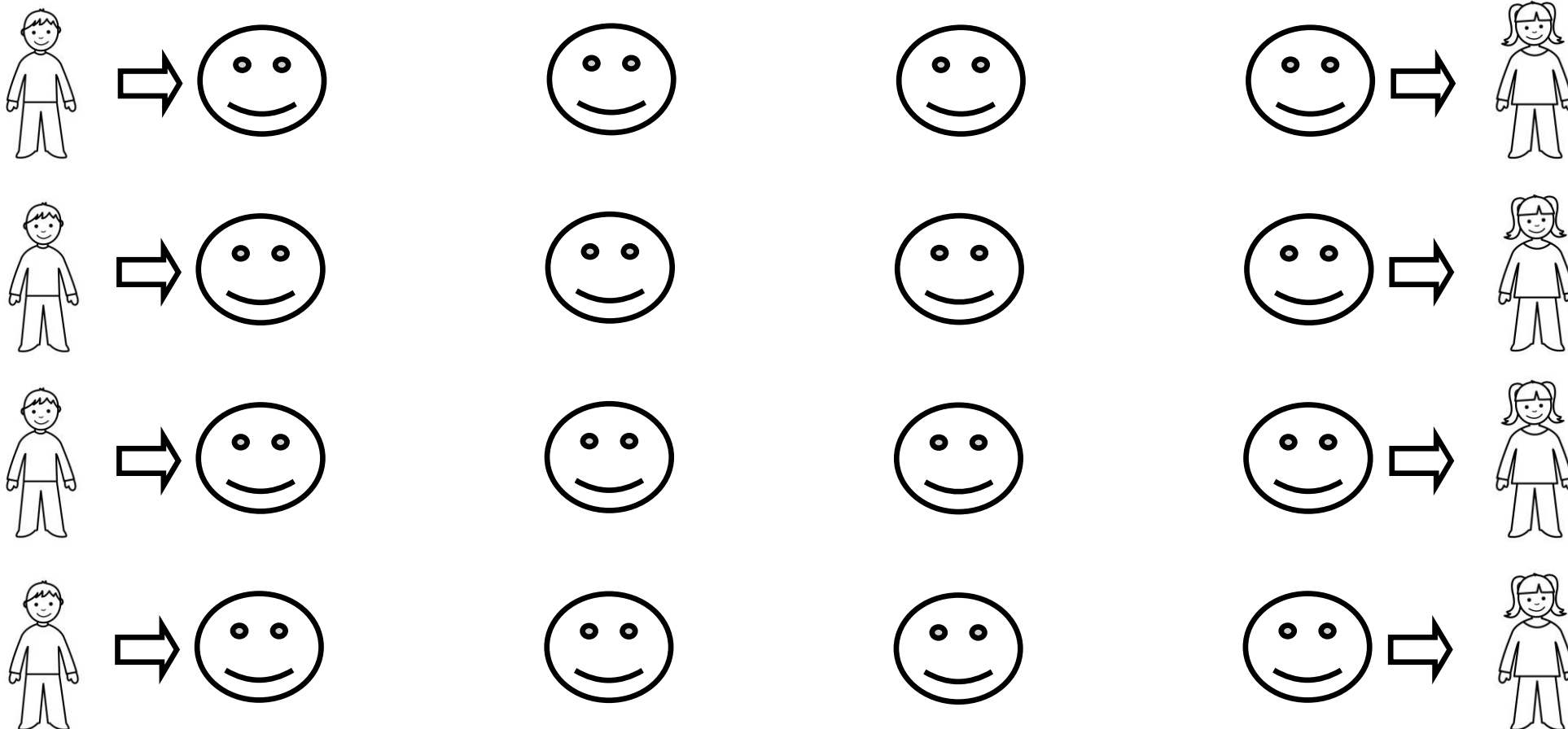

Actividades para mejorar motricidad fina

Sigue con tu lápiz los círculos para unir al niño con su balón

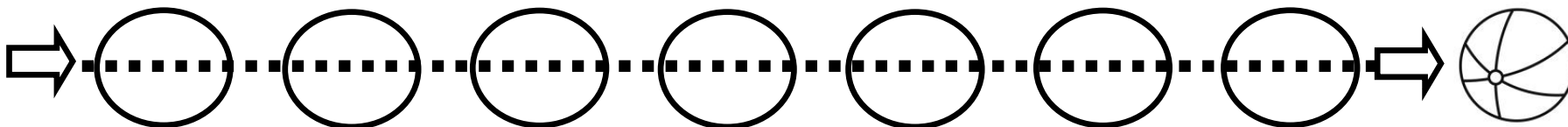
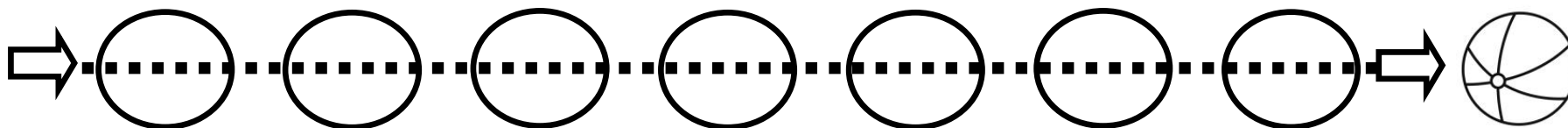
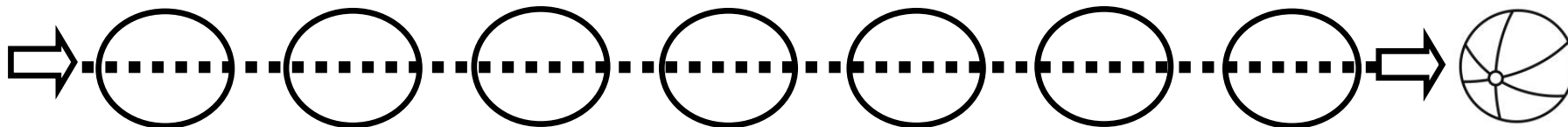
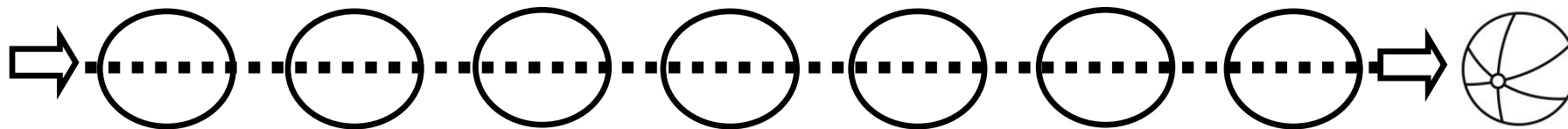

Actividades para mejorar motricidad fina

Sigue con tu lápiz los círculos para unir al niño con su balón

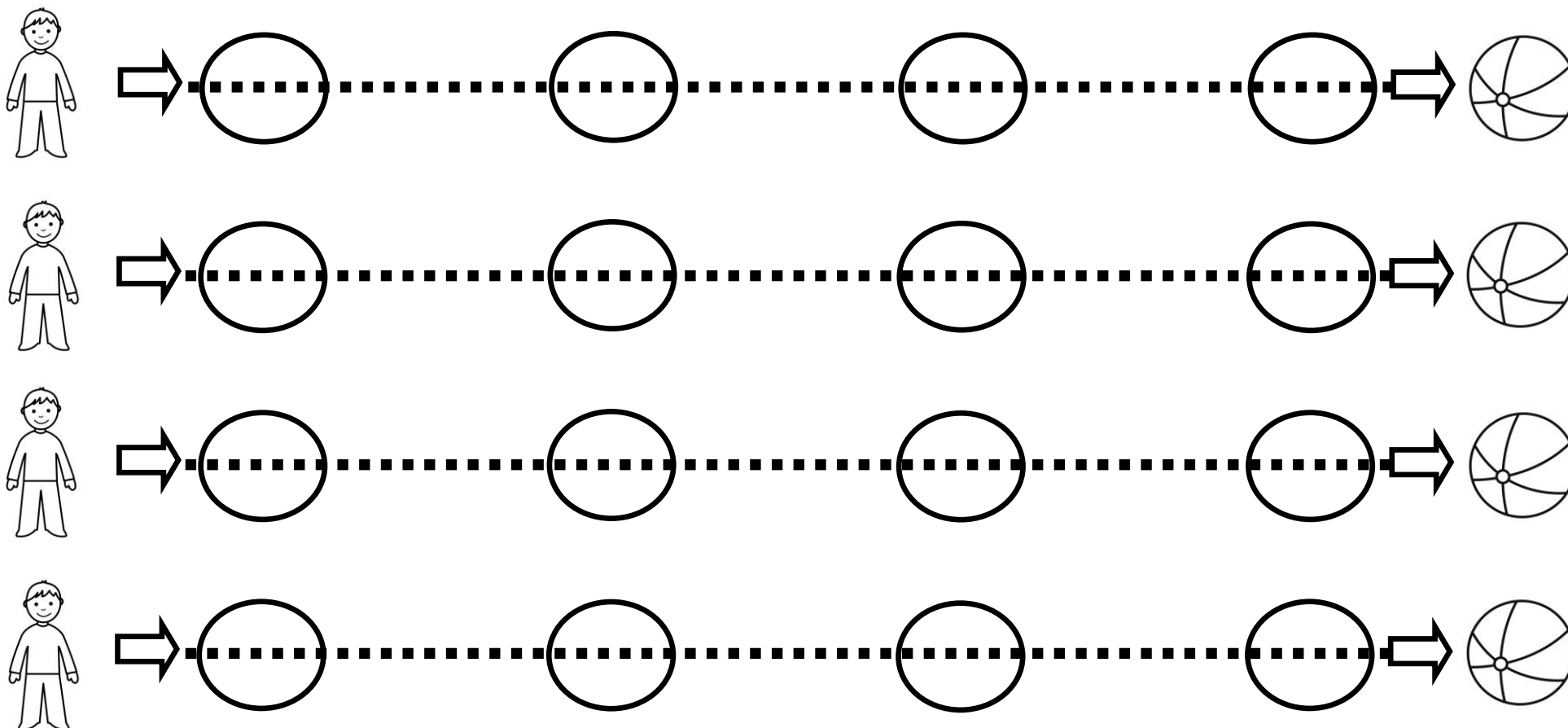

Actividades para mejorar motricidad fina

Sigue con tu lápiz los círculos para unir al niño con su balón

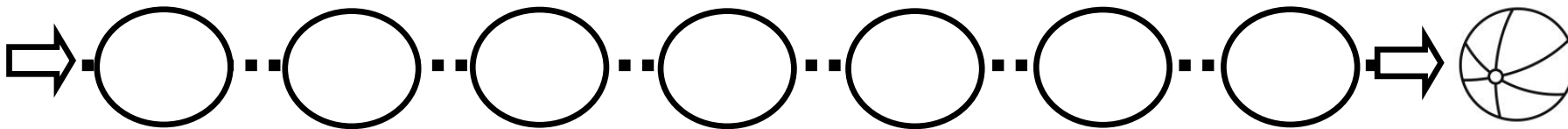
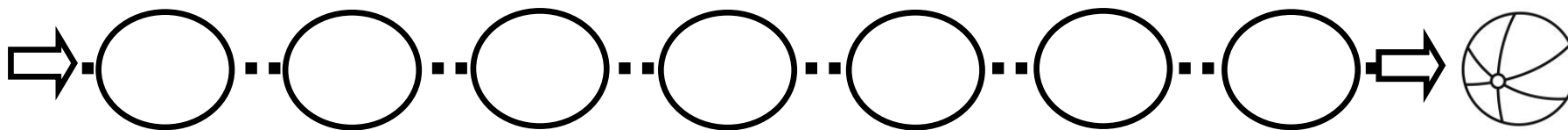
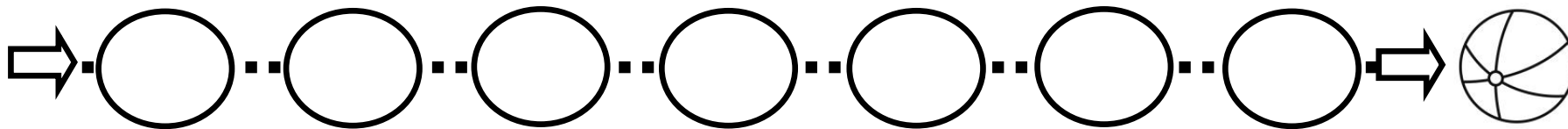
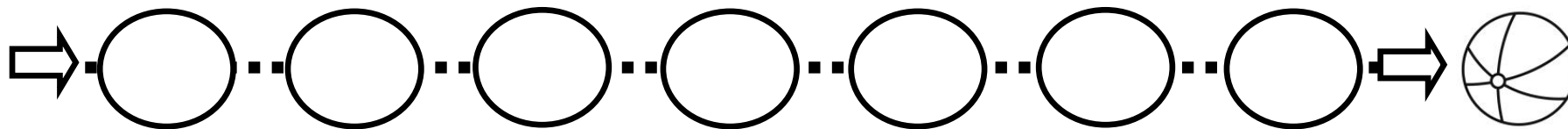

Actividades para mejorar motricidad fina

Sigue con tu lápiz los círculos para unir al niño con su balón

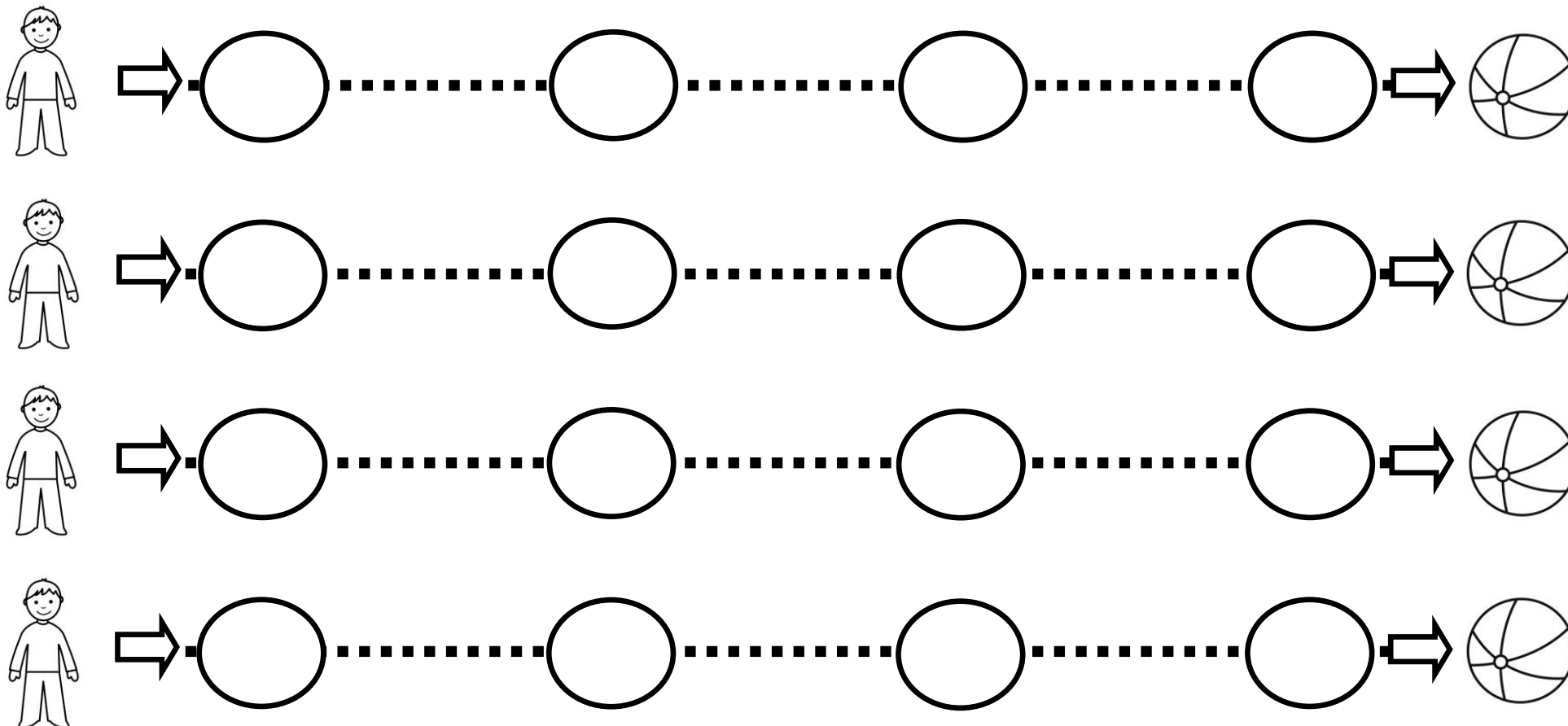

Actividades para mejorar motricidad fina

Sigue con tu lápiz los círculos para unir al niño con su balón

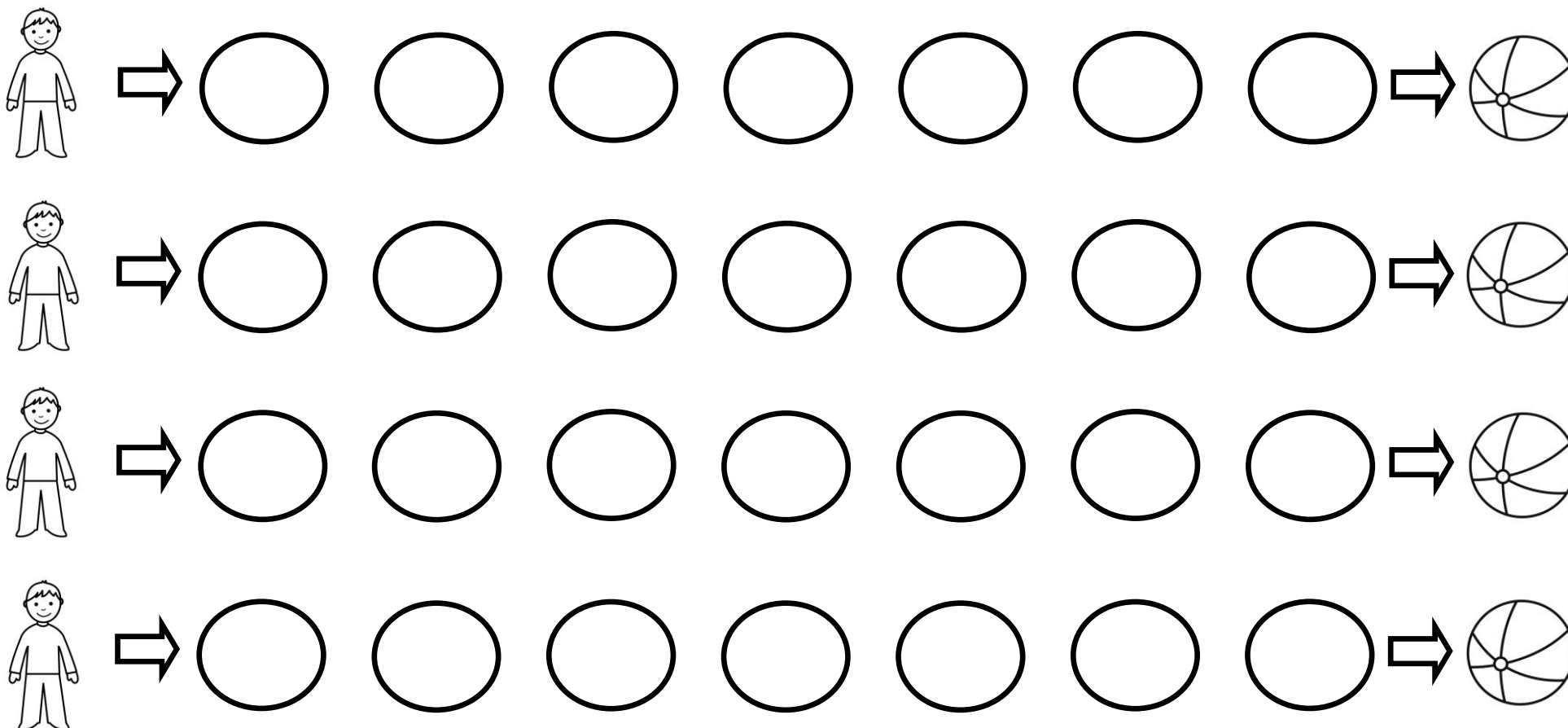

Actividades para mejorar motricidad fina

Sigue con tu lápiz los círculos para unir al niño con su balón

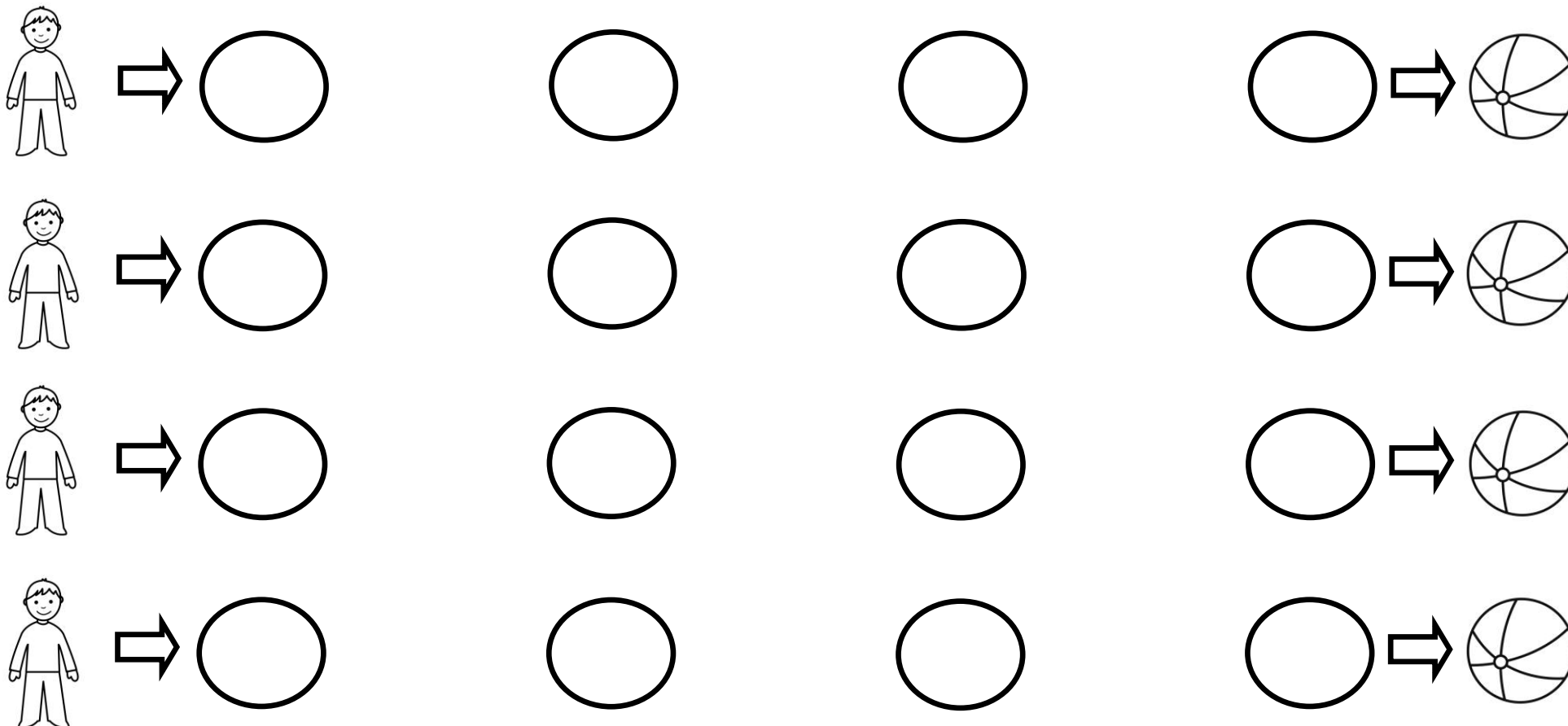

Actividades para mejorar motricidad fina

Sigue con tu lápiz los rayos para unir a nube y la tierra

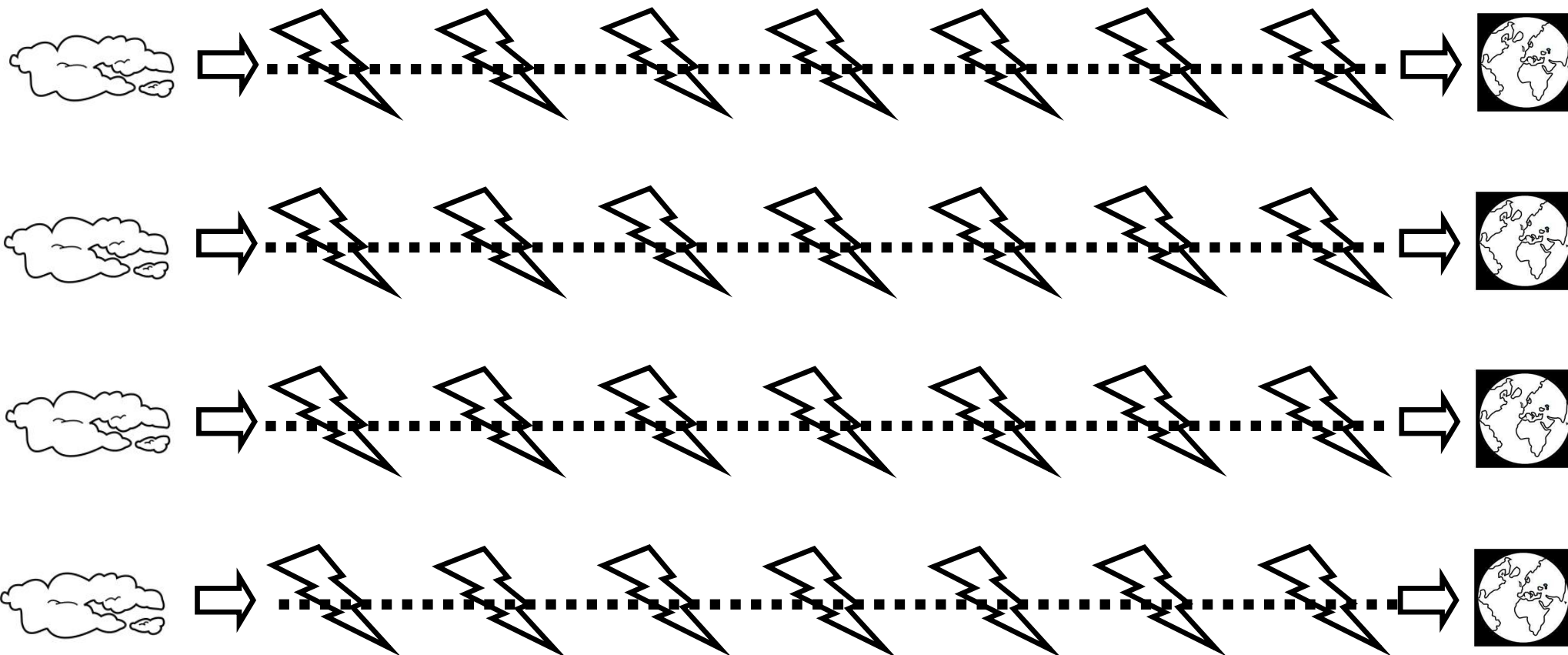

Actividades para mejorar motricidad fina

Sigue con tu lápiz los rayos para unir a nube y la tierra

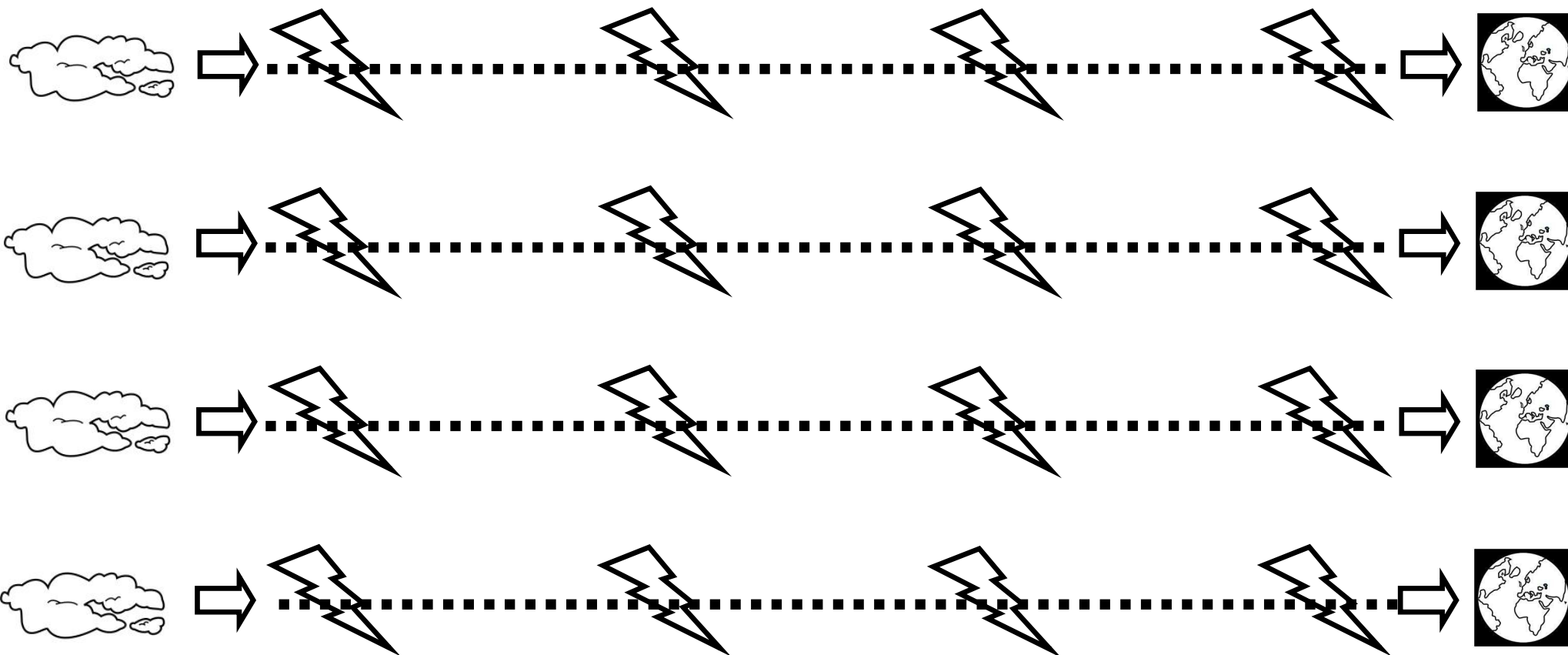

Actividades para mejorar motricidad fina

Sigue con tu lápiz los rayos para unir a nube y la tierra

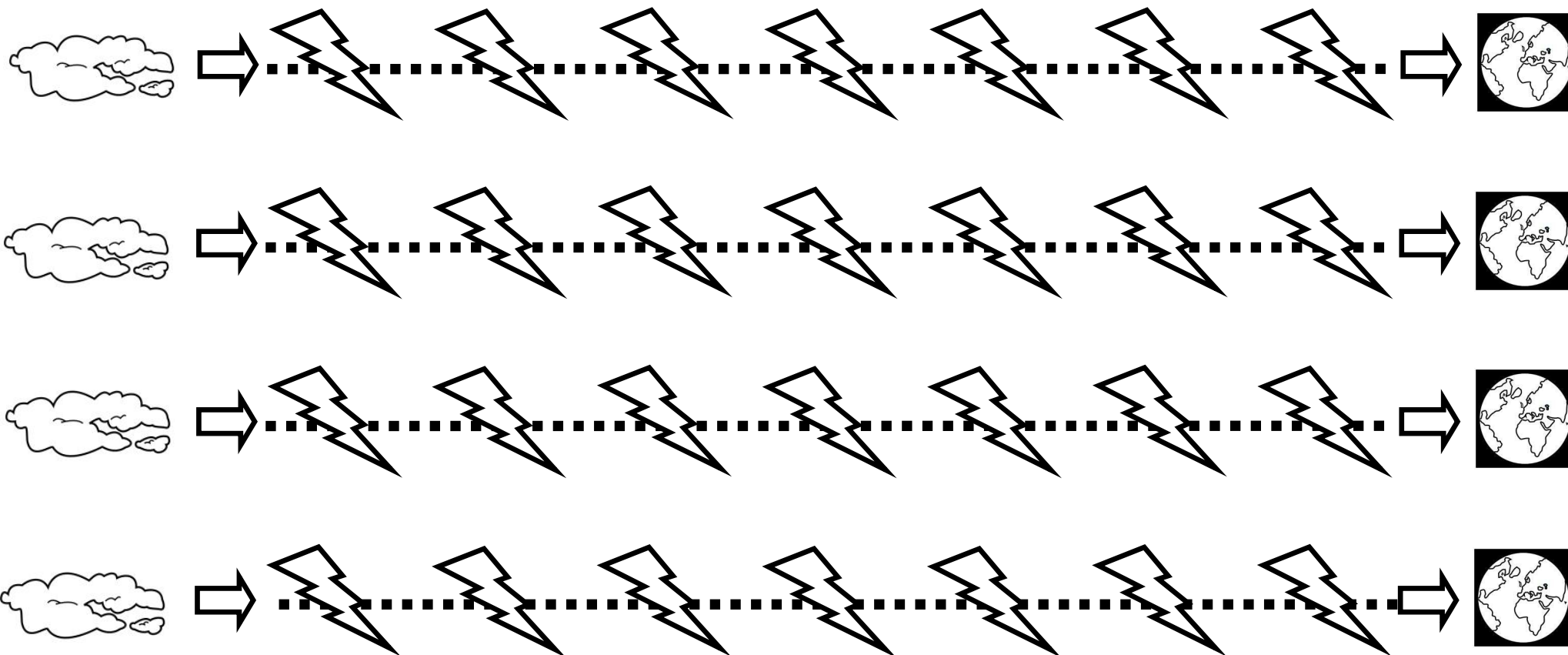

Actividades para mejorar motricidad fina

Sigue con tu lápiz los rayos para unir a nube y la tierra

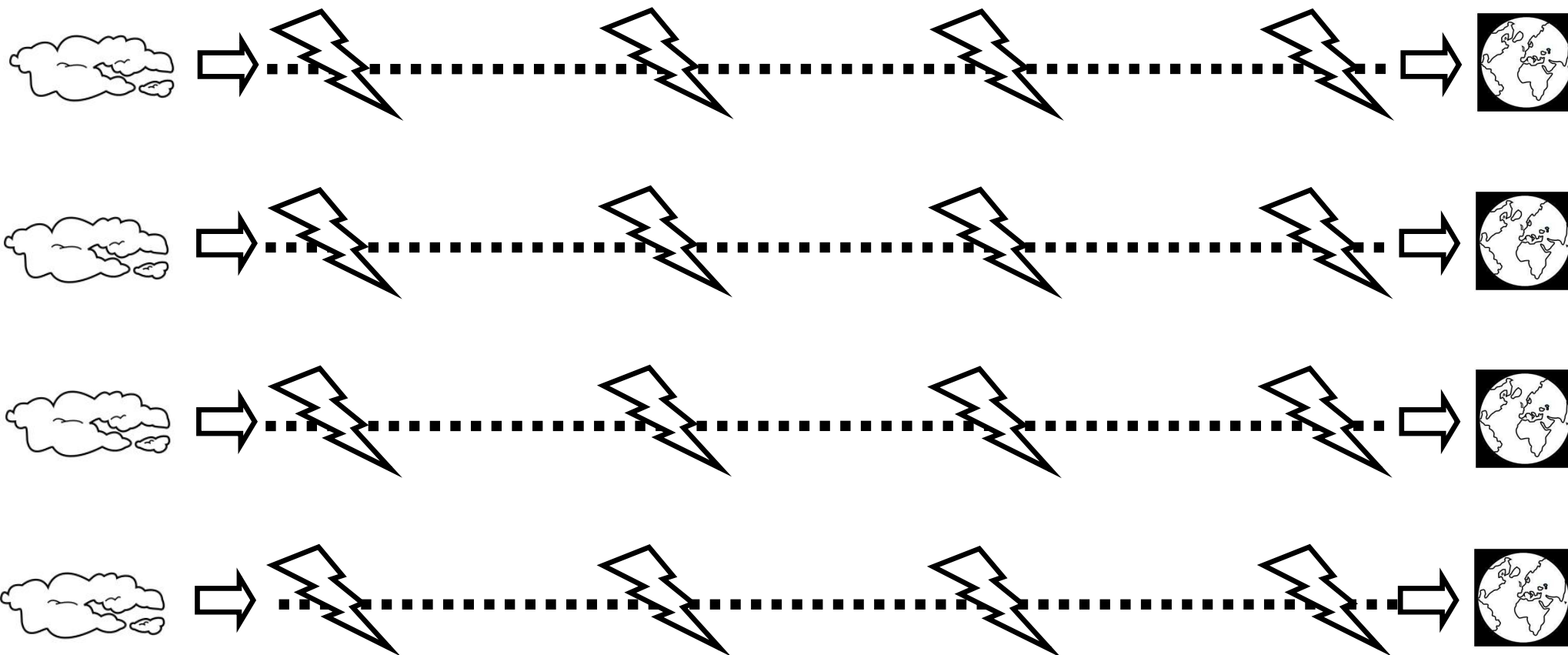

Actividades para mejorar motricidad fina

Sigue con tu lápiz los rayos para unir a nube y la tierra

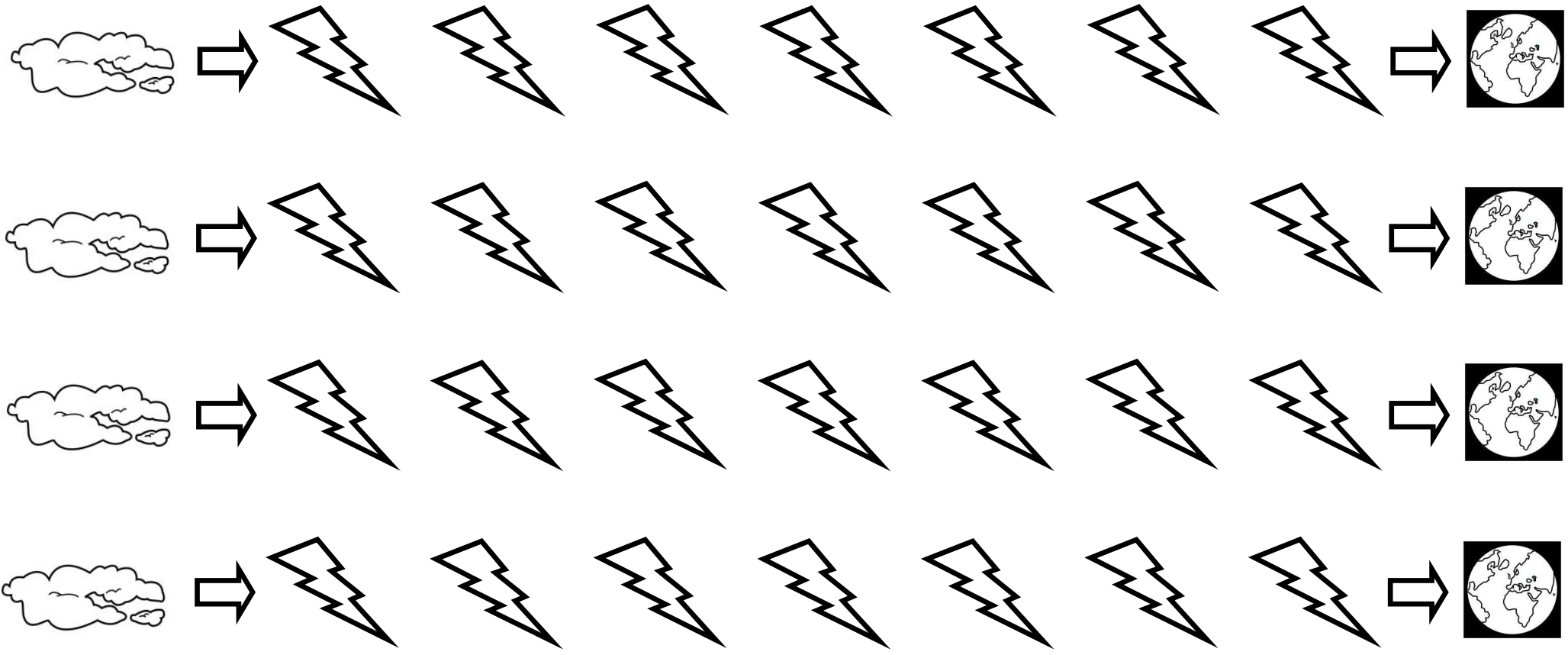

Actividades para mejorar motricidad fina

Sigue con tu lápiz los rayos para unir a nube y la tierra

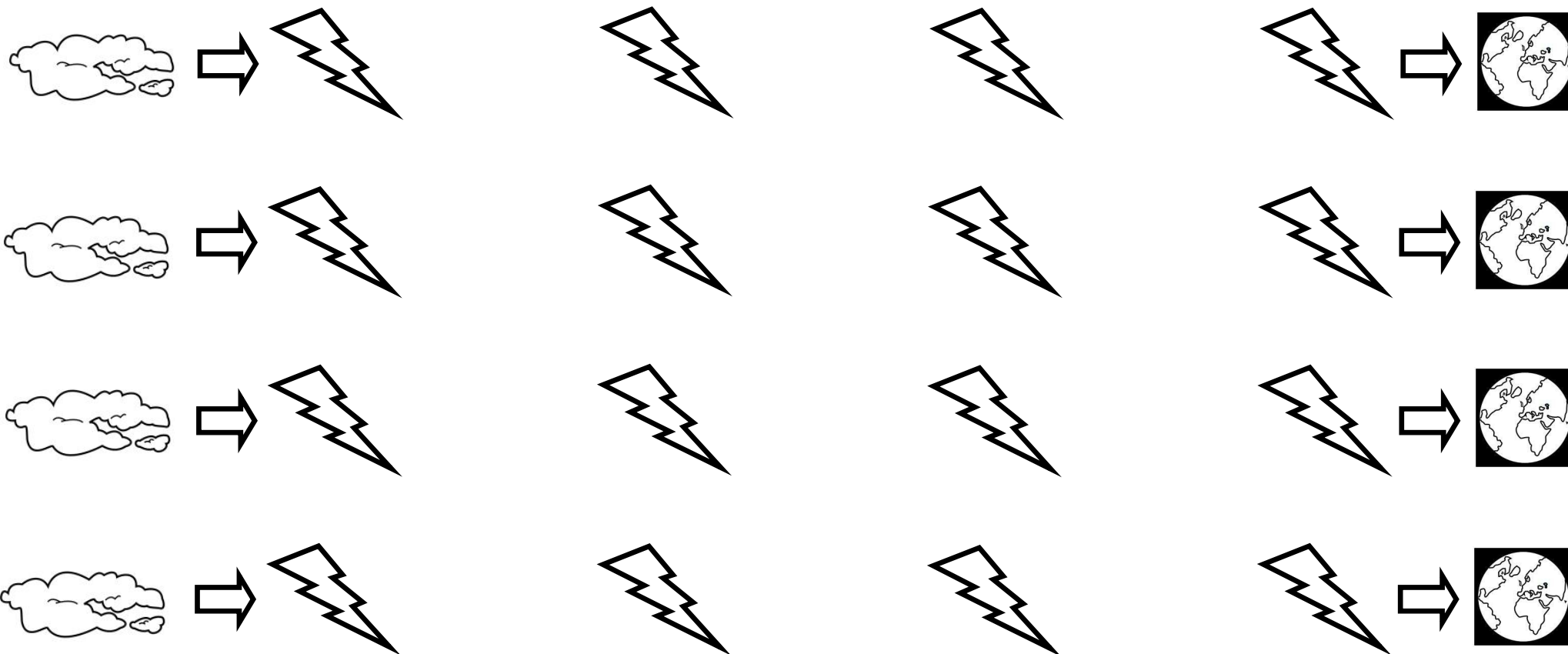

Actividades para mejorar motricidad fina

Sigue con tu lápiz las estrellitas para ir desde el sol a la tierra

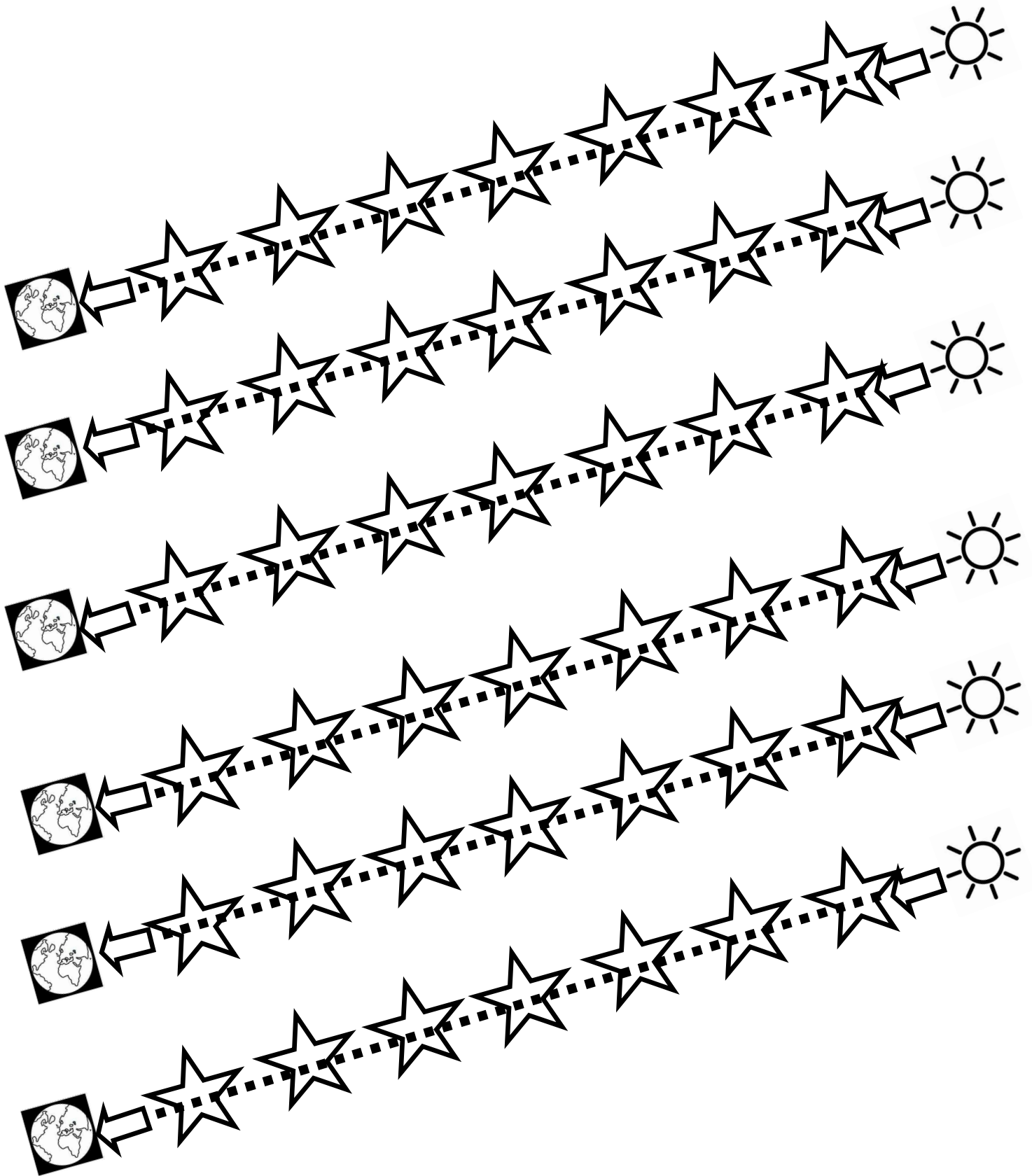

Actividades para mejorar motricidad fina

Sigue con tu lápiz las estrellitas para ir desde el sol a la tierra

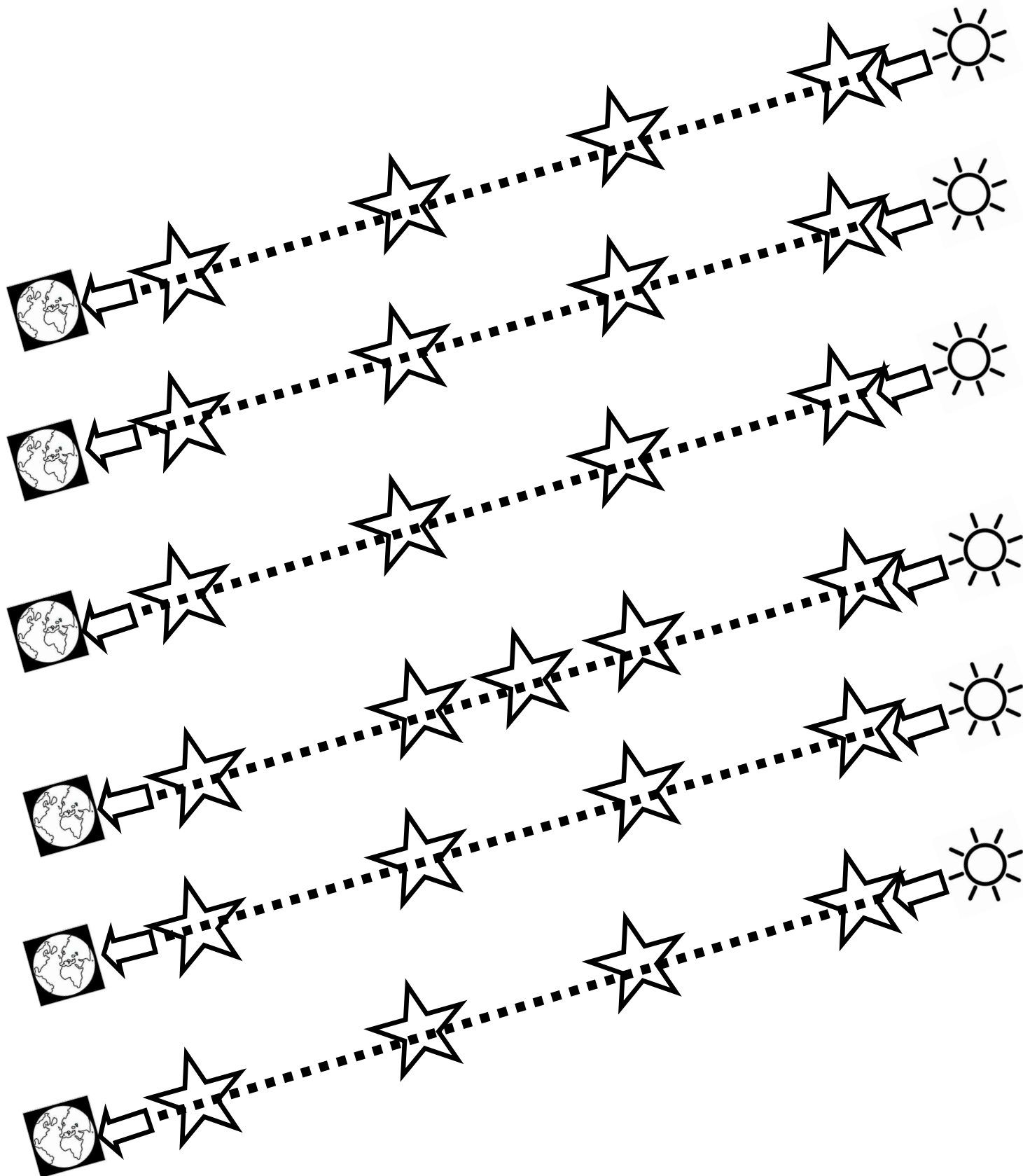

Actividades para mejorar motricidad fina

Sigue con tu lápiz las estrellitas para ir desde el sol a la tierra

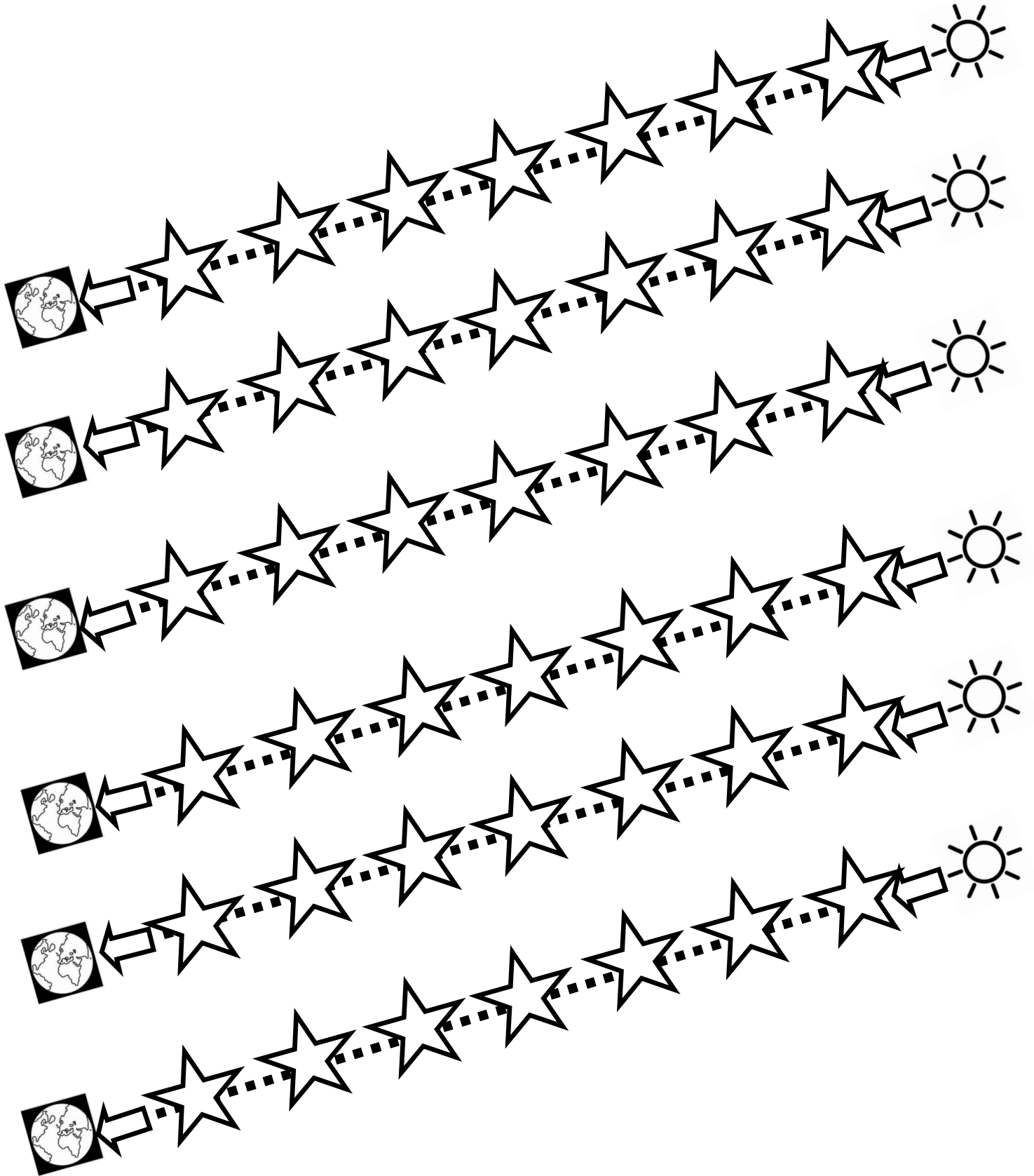

Actividades para mejorar motricidad fina

Sigue con tu lápiz las estrellitas para ir desde el sol a la tierra

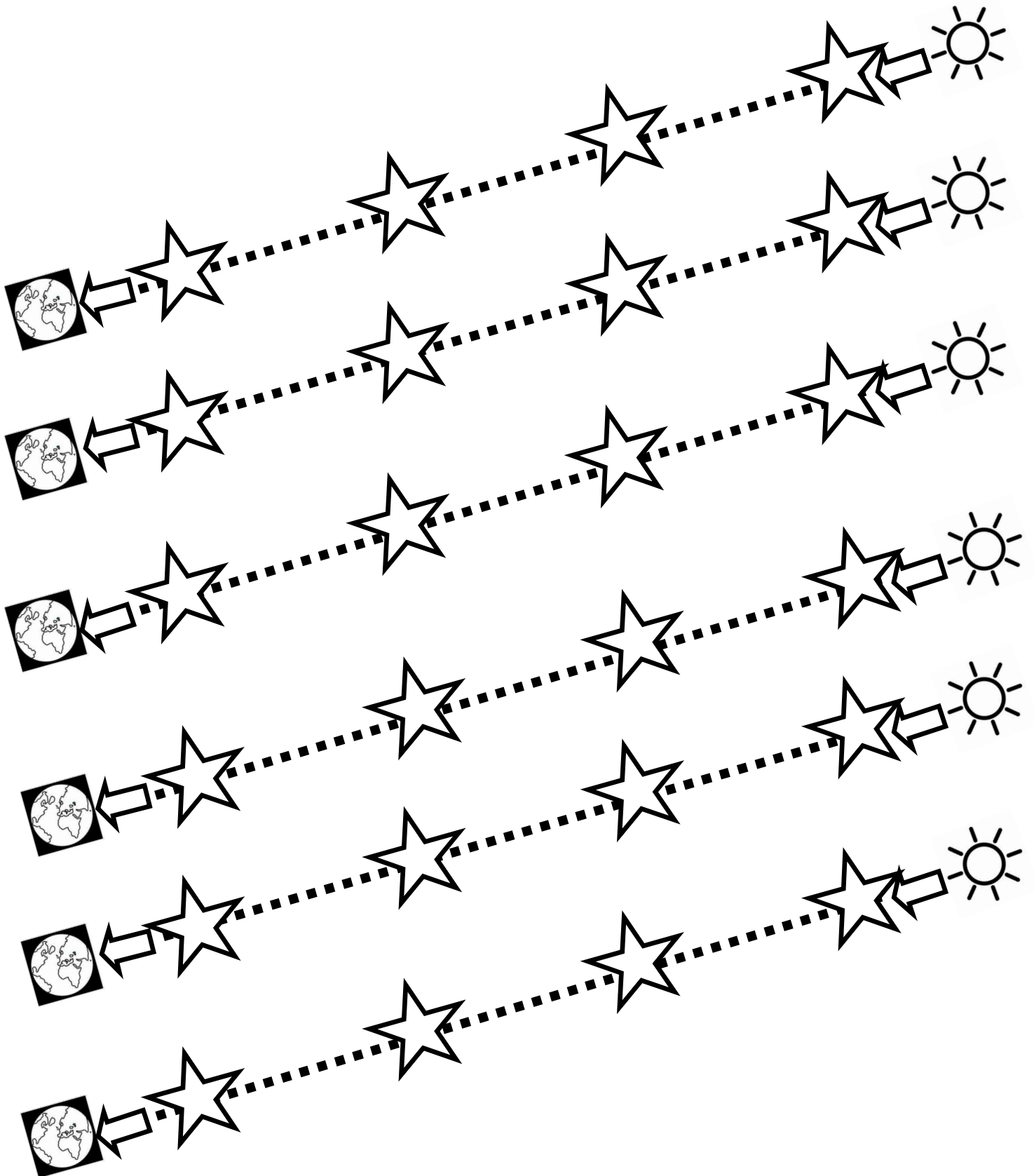

Actividades para mejorar motricidad fina

Sigue con tu lápiz las estrellitas para ir desde el sol a la tierra

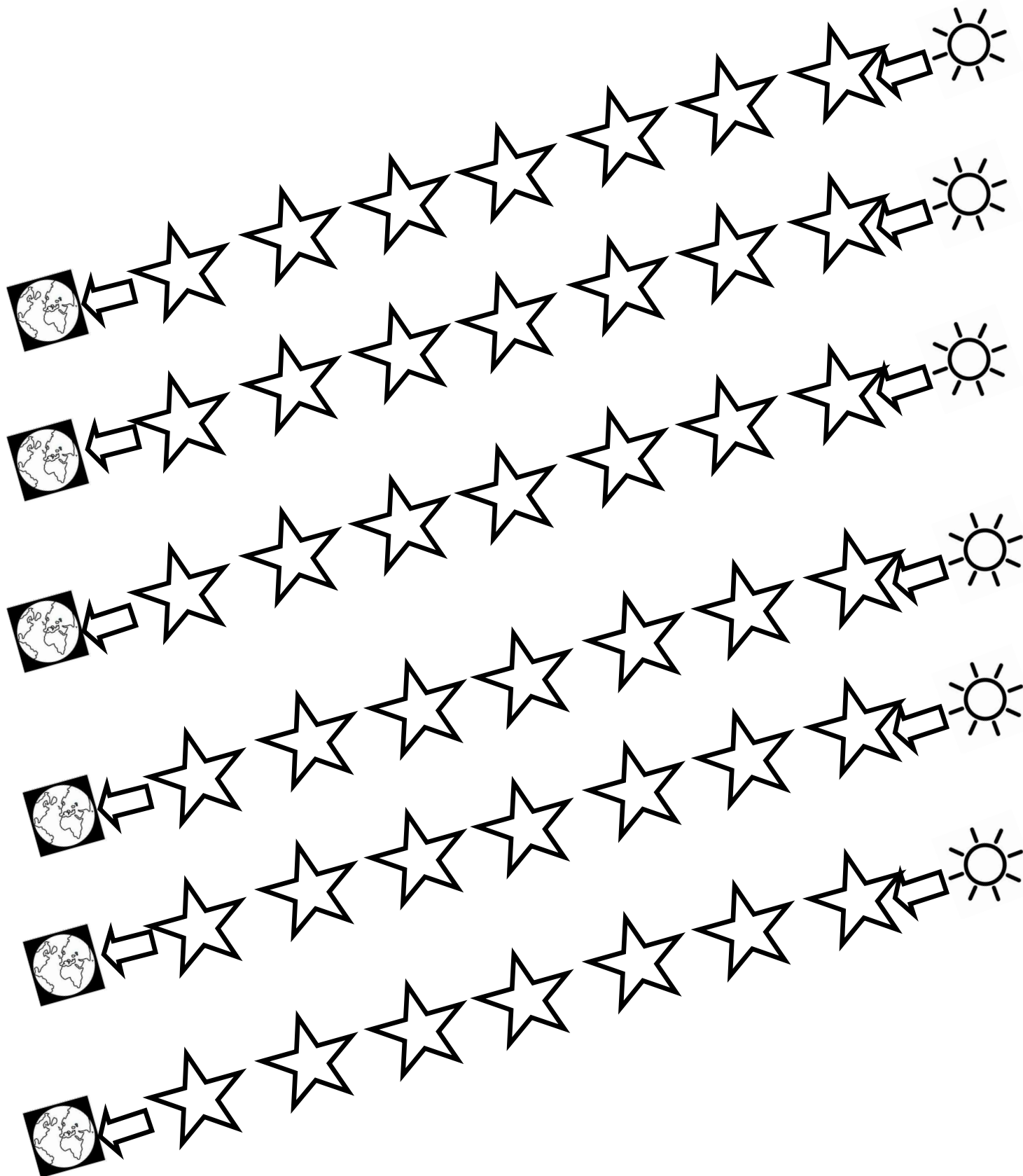

Actividades para mejorar motricidad fina

Sigue con tu lápiz las estrellitas para ir desde el sol a la tierra



Actividades para mejorar motricidad fina

Sigue con tu lápiz los corazones para unir a la mama y a su bebe

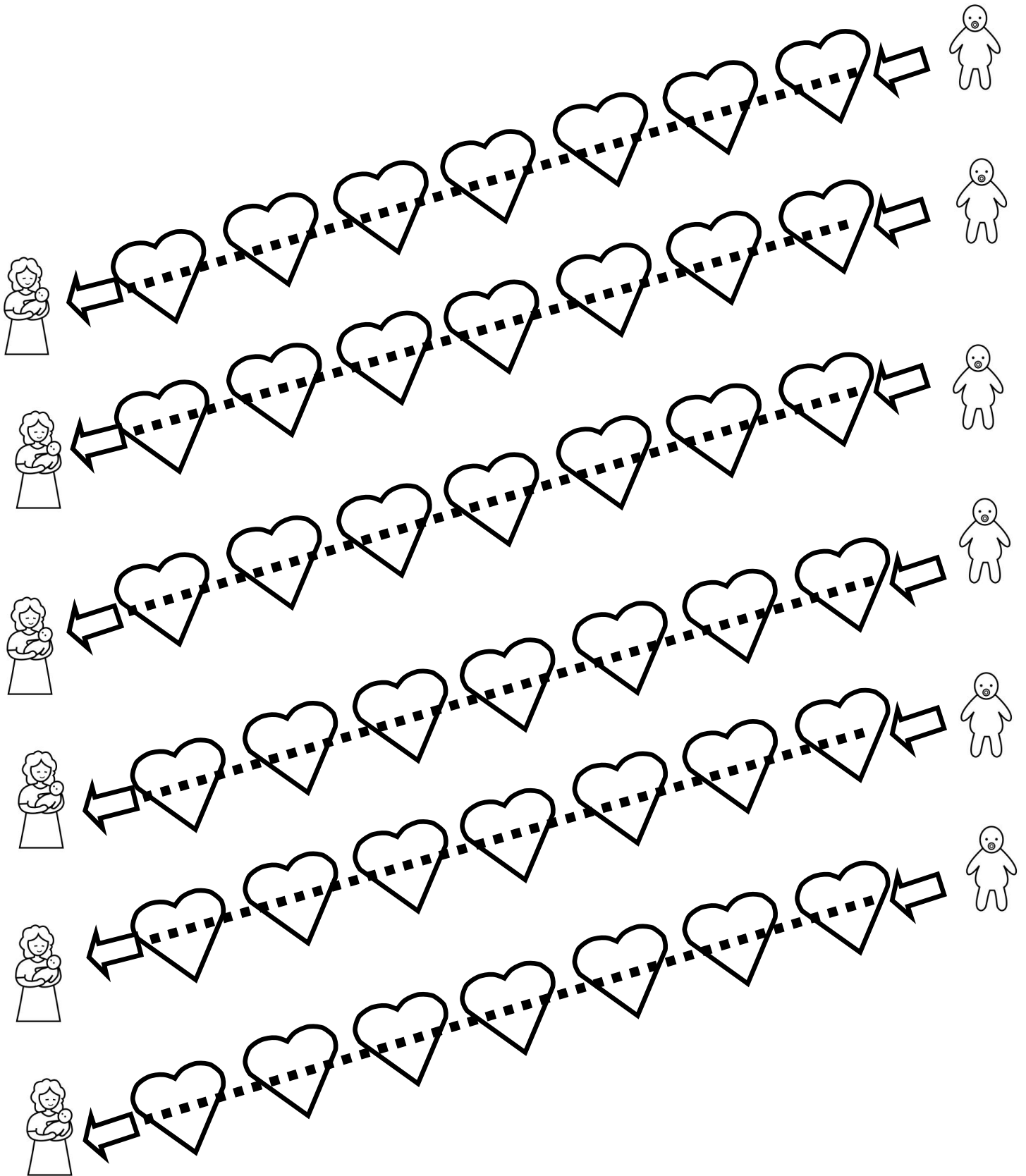

Actividades para mejorar motricidad fina

Sigue con tu lápiz los corazones para unir a la mama y a su bebe

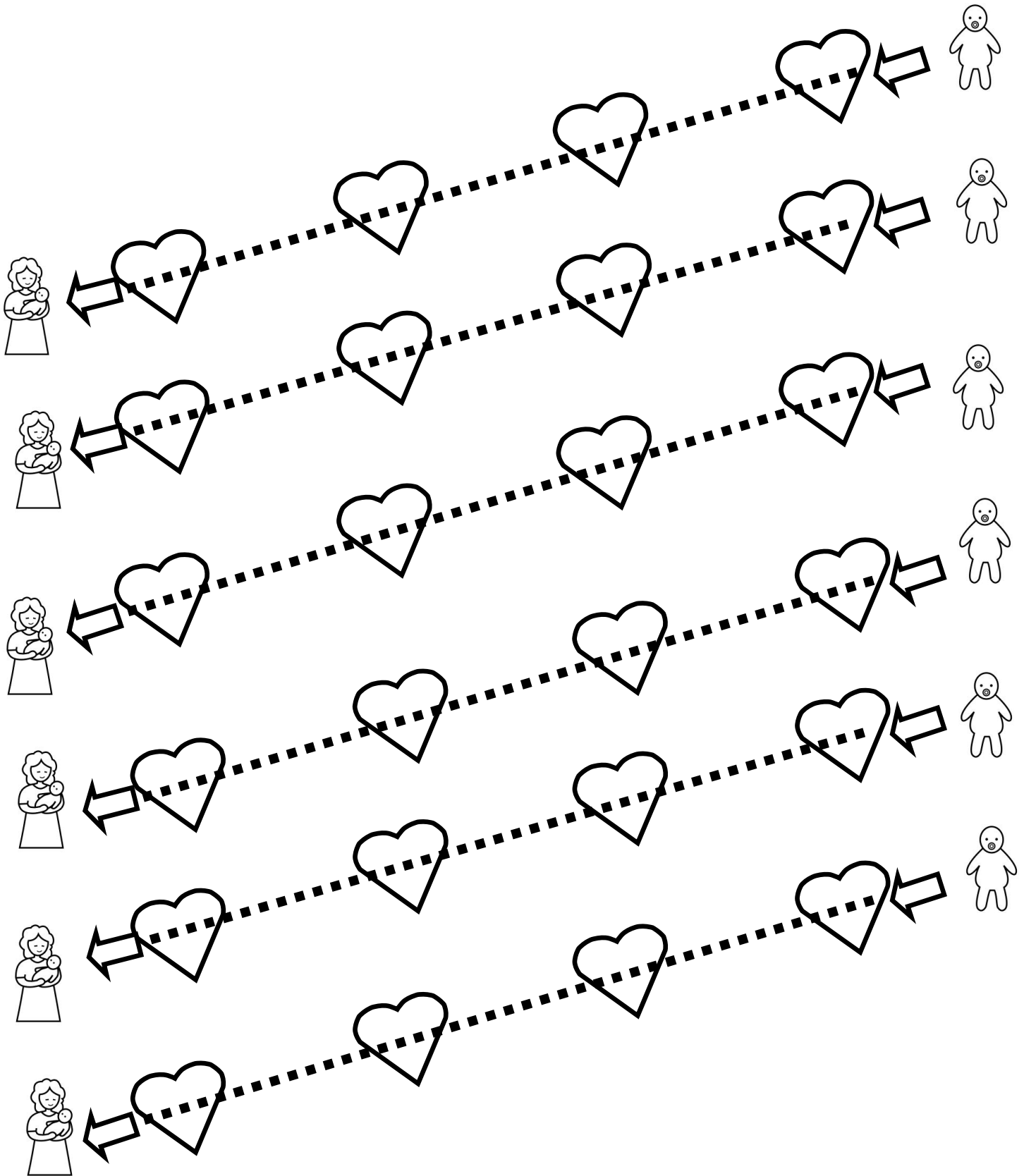

Actividades para mejorar motricidad fina

Sigue con tu lápiz los corazones para unir a la mama y a su bebe

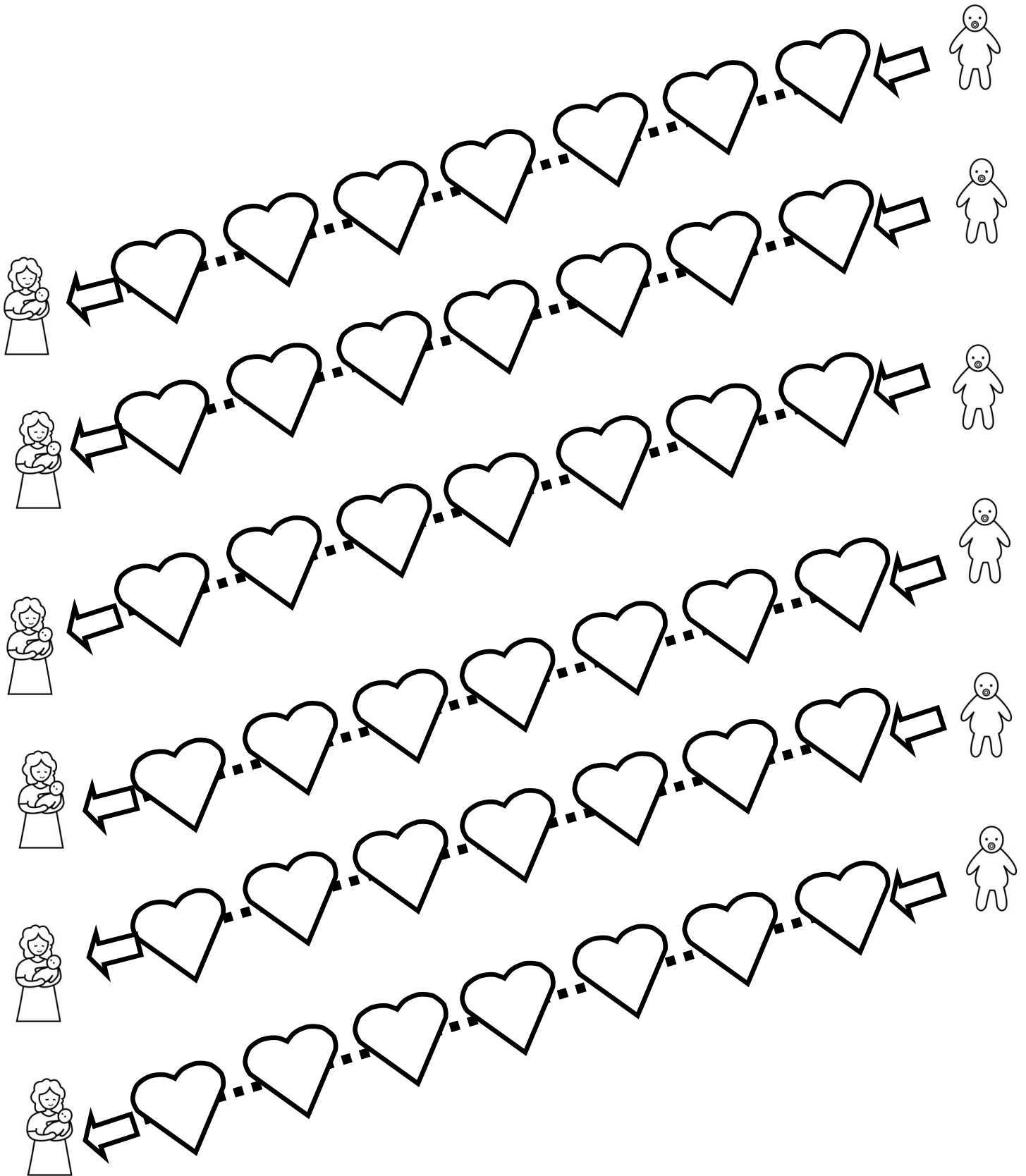

Actividades para mejorar motricidad fina

Sigue con tu lápiz los corazones para unir a la mama y a su bebe

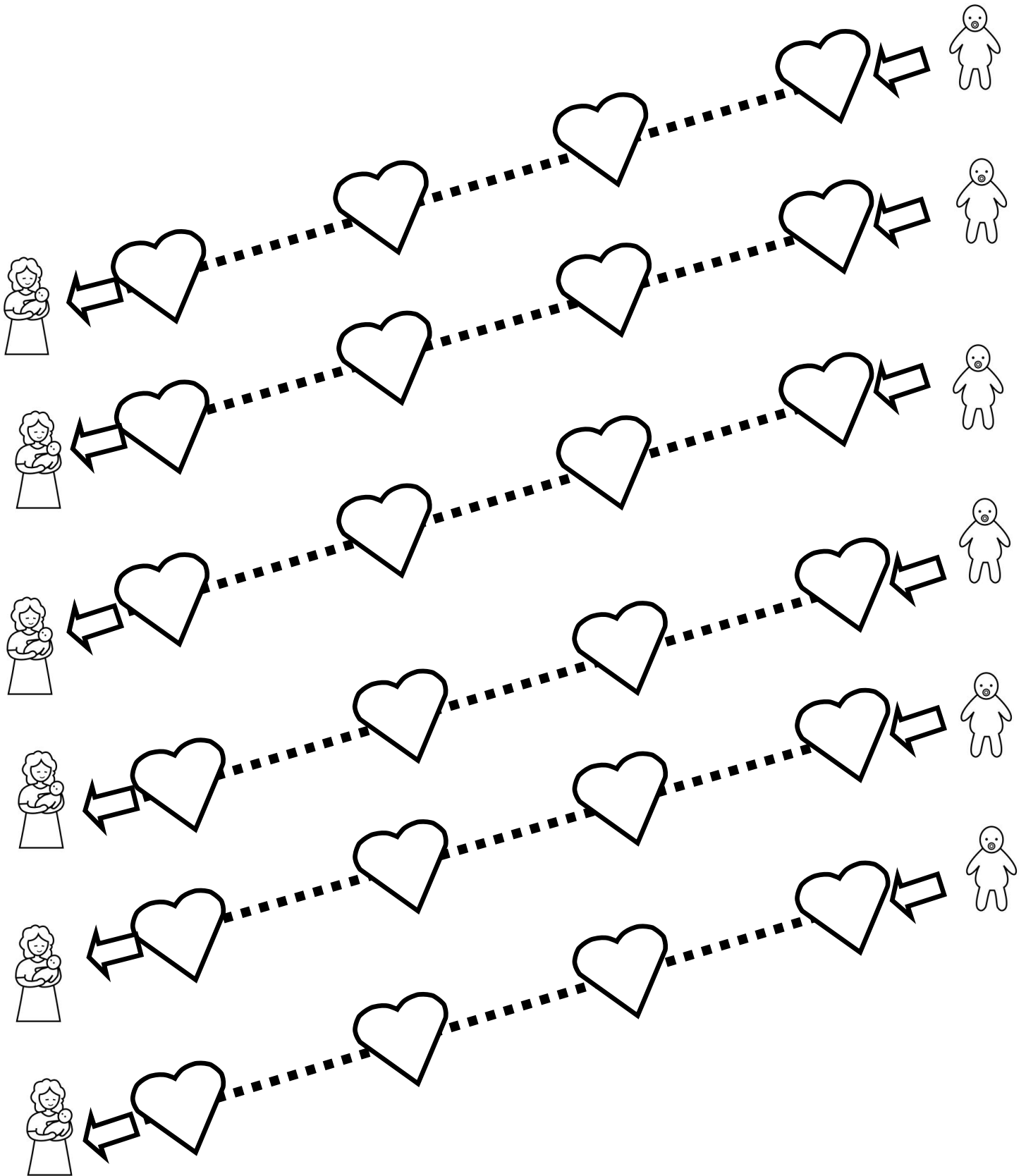

Actividades para mejorar motricidad fina

Sigue con tu lápiz los corazones para unir a la mama y a su bebe

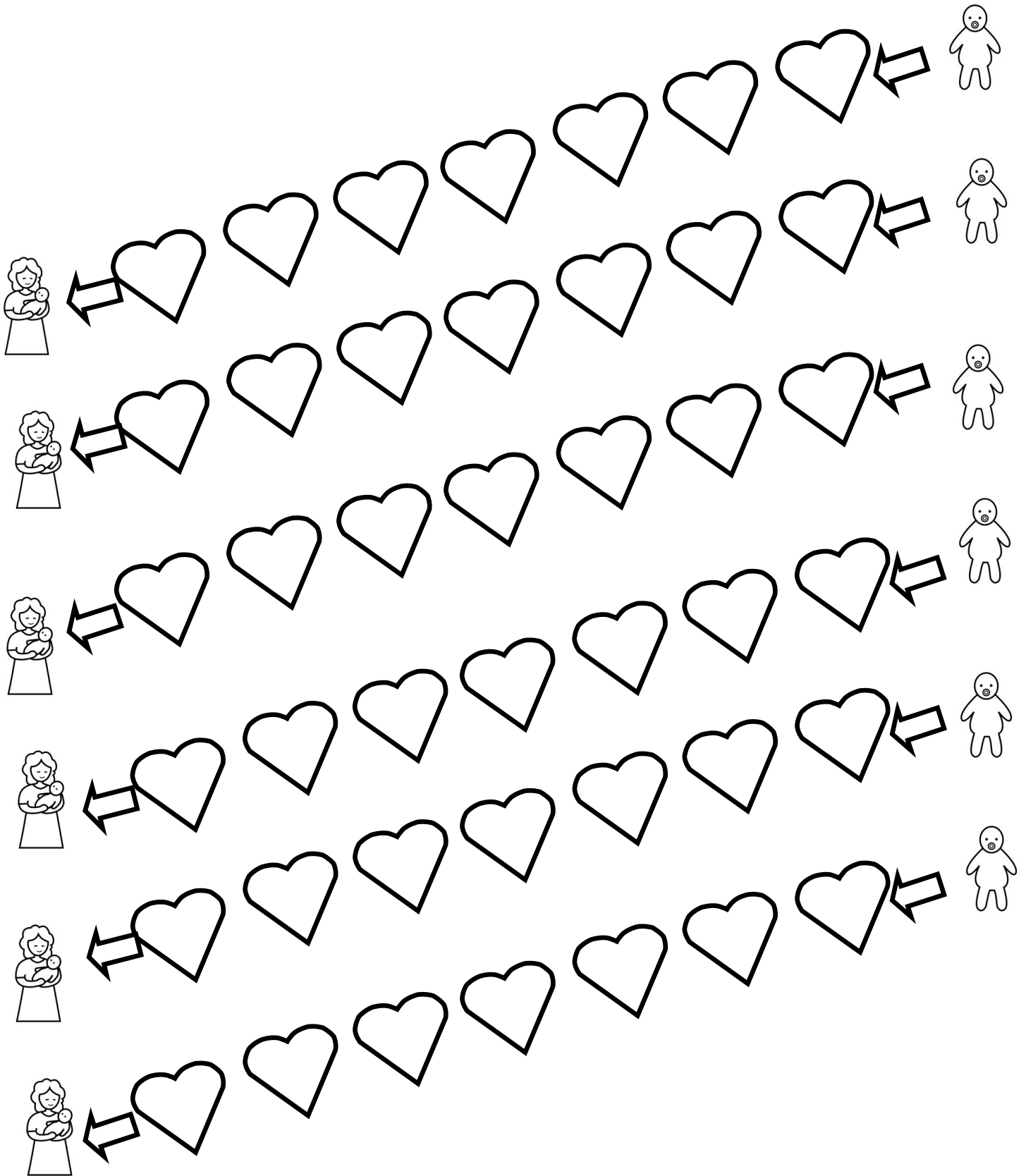

Actividades para mejorar motricidad fina

Sigue con tu lápiz los corazones para unir a la mama y a su bebe

Actividades para mejorar motricidad fina

Sigue con tu lápiz las caras para unir al niño con su amiga

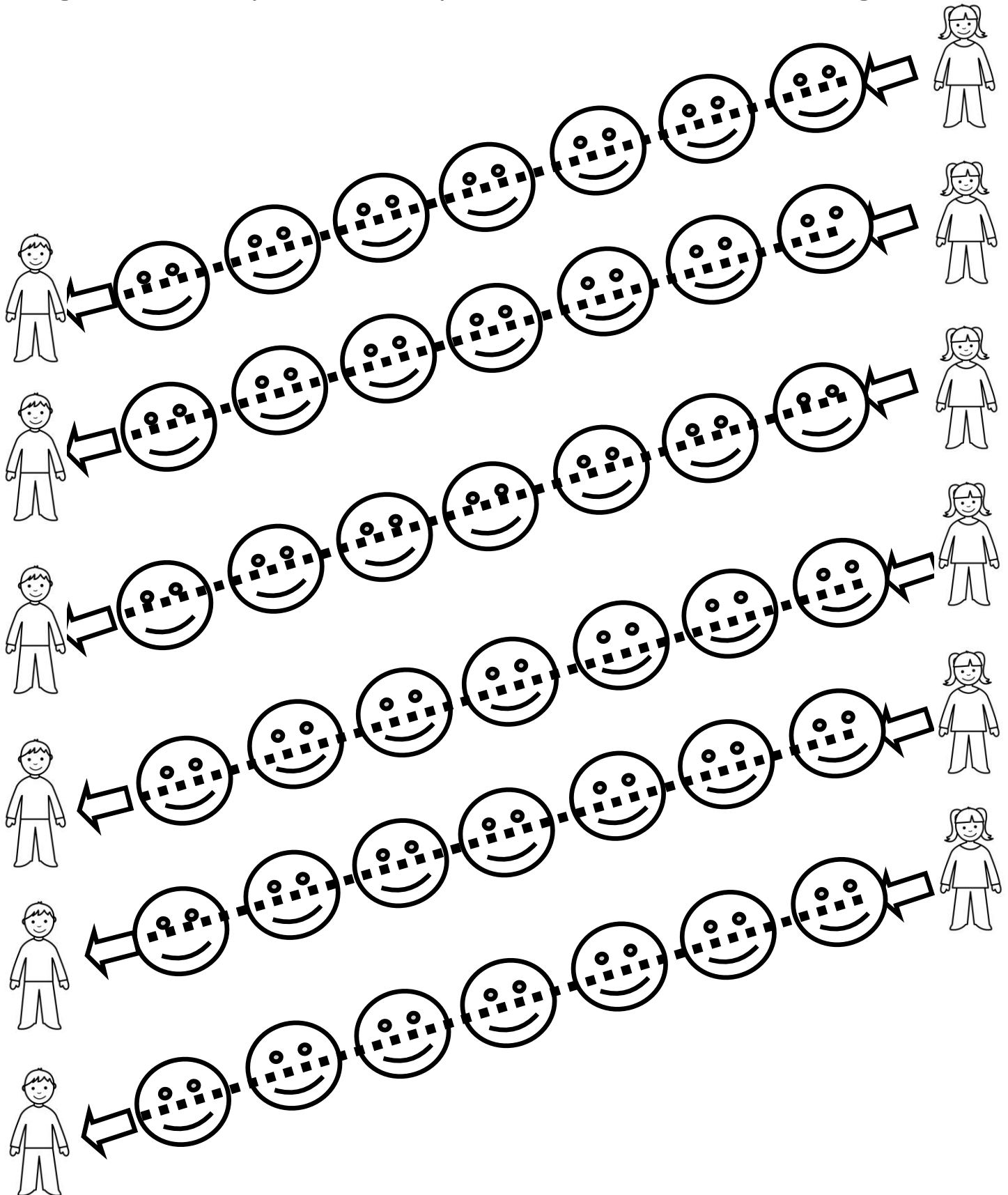

Actividades para mejorar motricidad fina

Sigue con tu lápiz las caras para unir al niño con su amiga

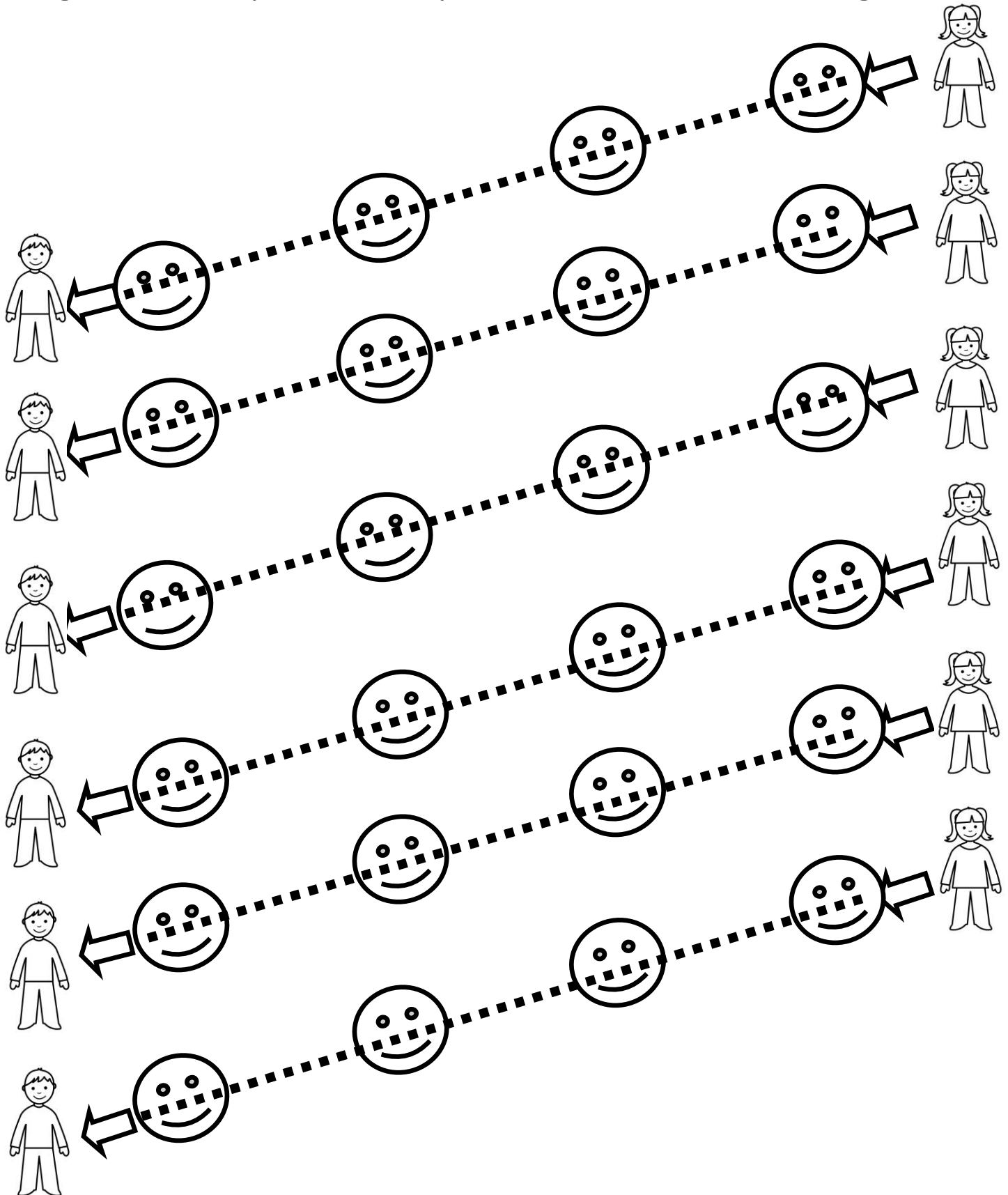

Actividades para mejorar motricidad fina

Sigue con tu lápiz las caras para unir al niño con su amiga

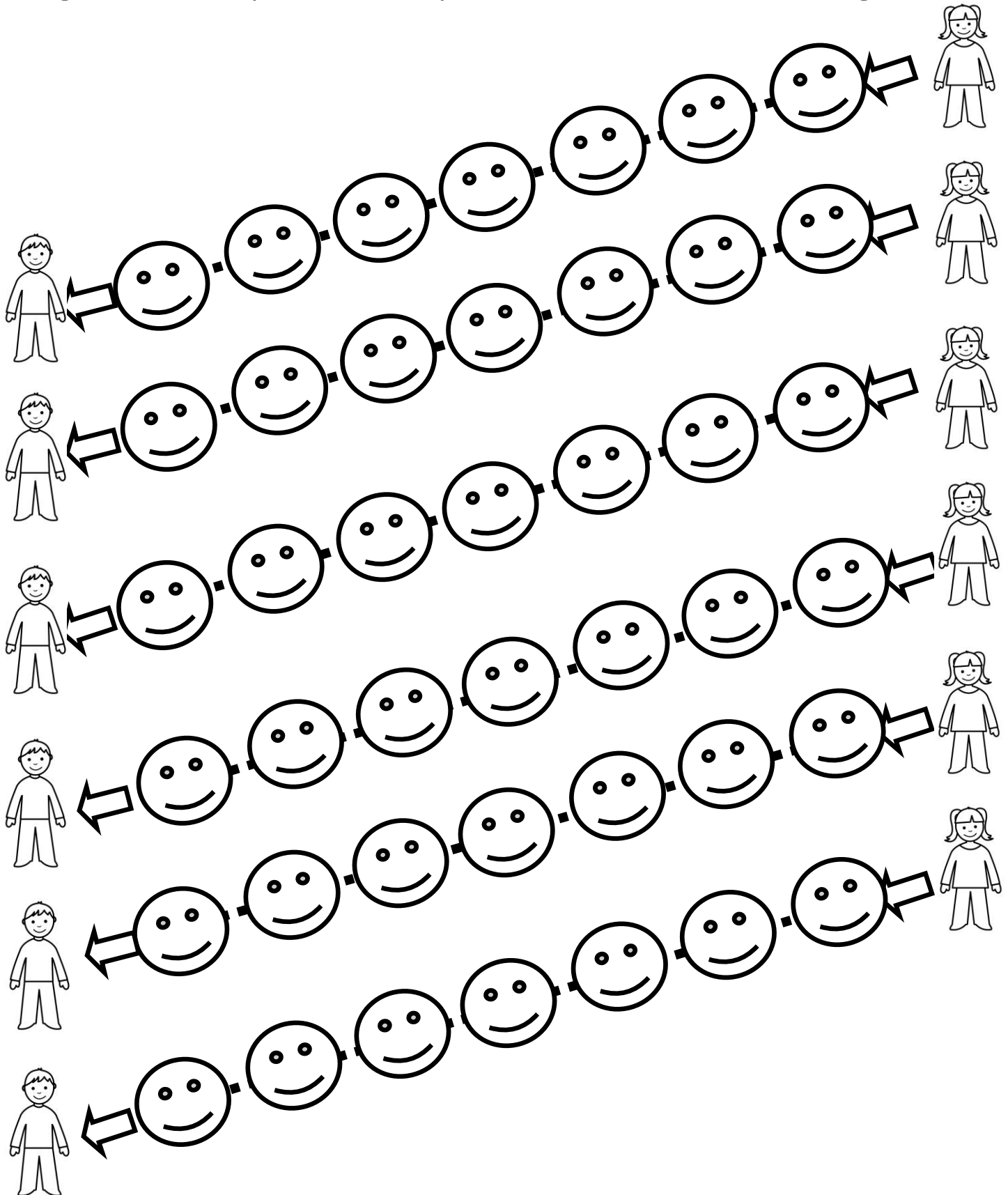

Actividades para mejorar motricidad fina

Sigue con tu lápiz las caras para unir al niño con su amiga

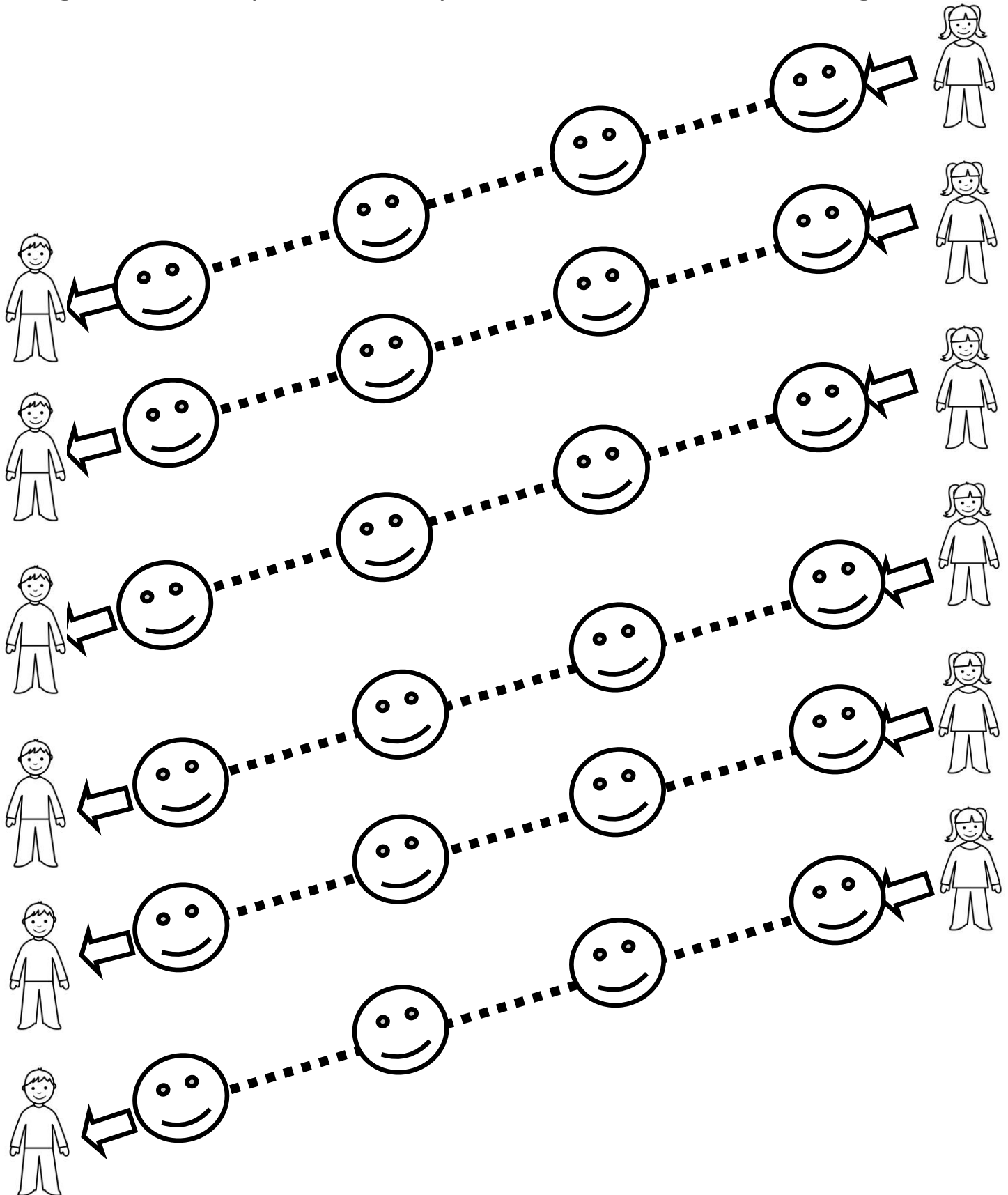

Actividades para mejorar motricidad fina

Sigue con tu lápiz las caras para unir al niño con su amiga

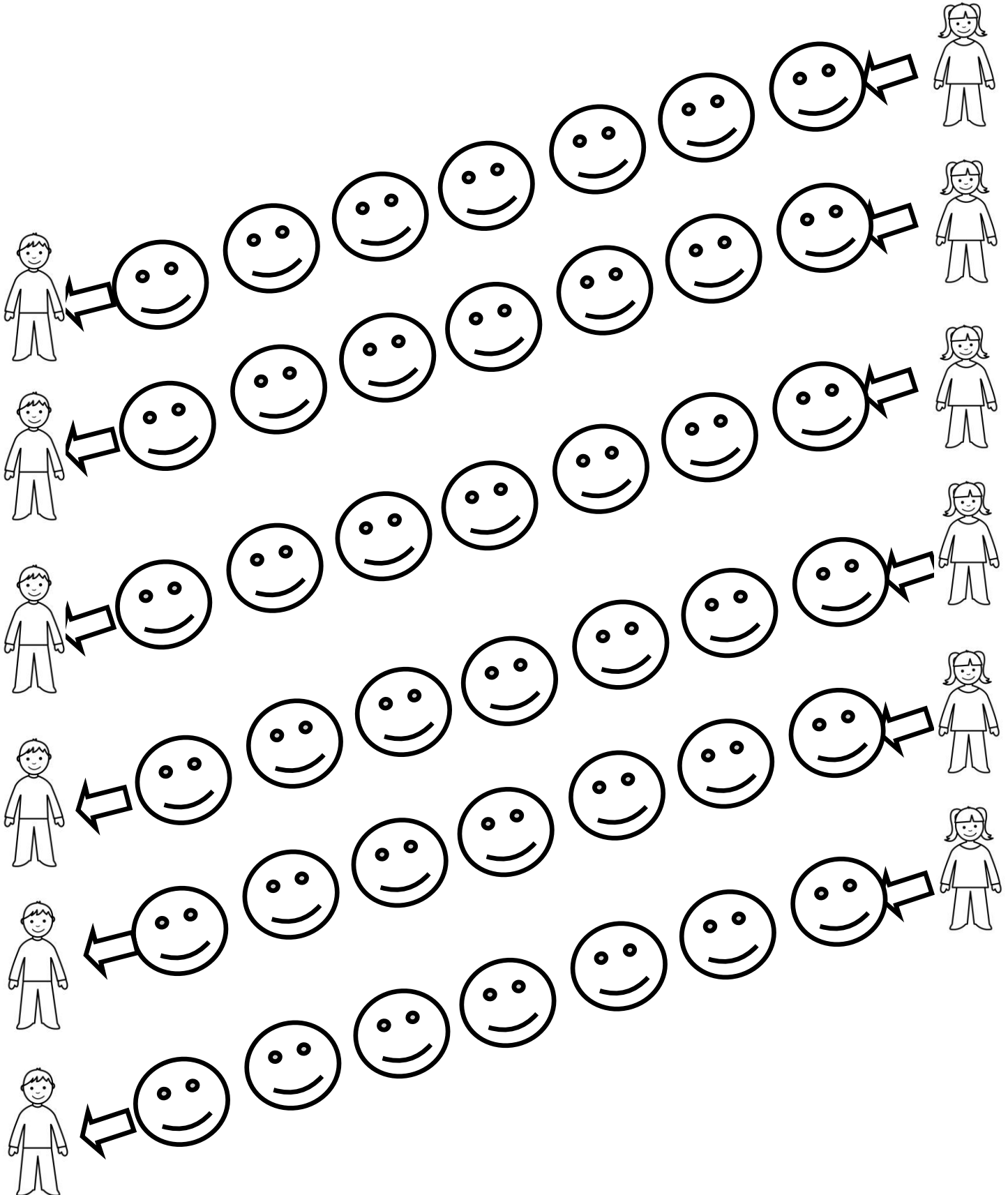

Actividades para mejorar motricidad fina

Sigue con tu lápiz las caras para unir al niño con su amiga

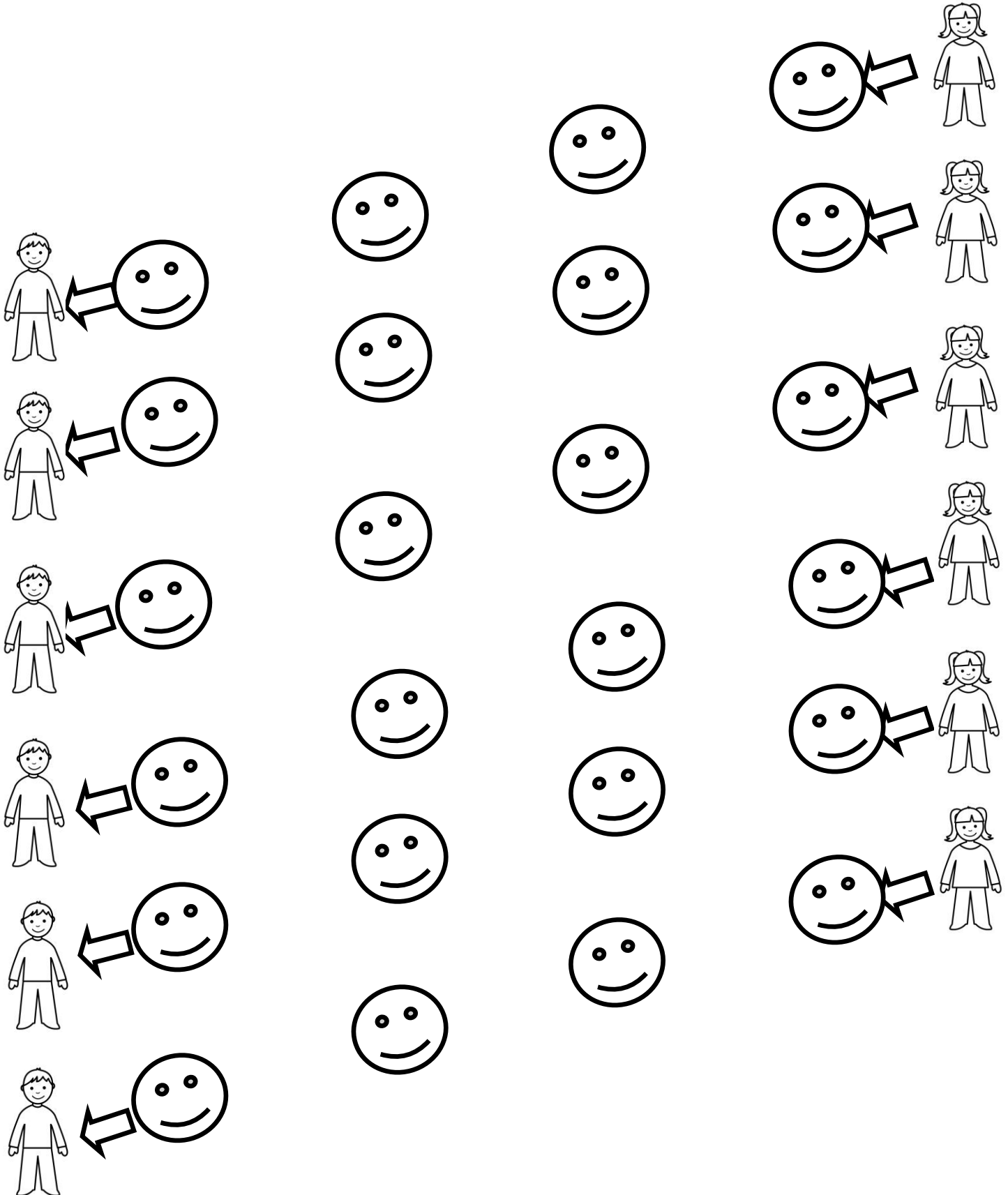

Actividades para mejorar motricidad fina

Sigue con tu lápiz los círculos para unir al niño con su pelota

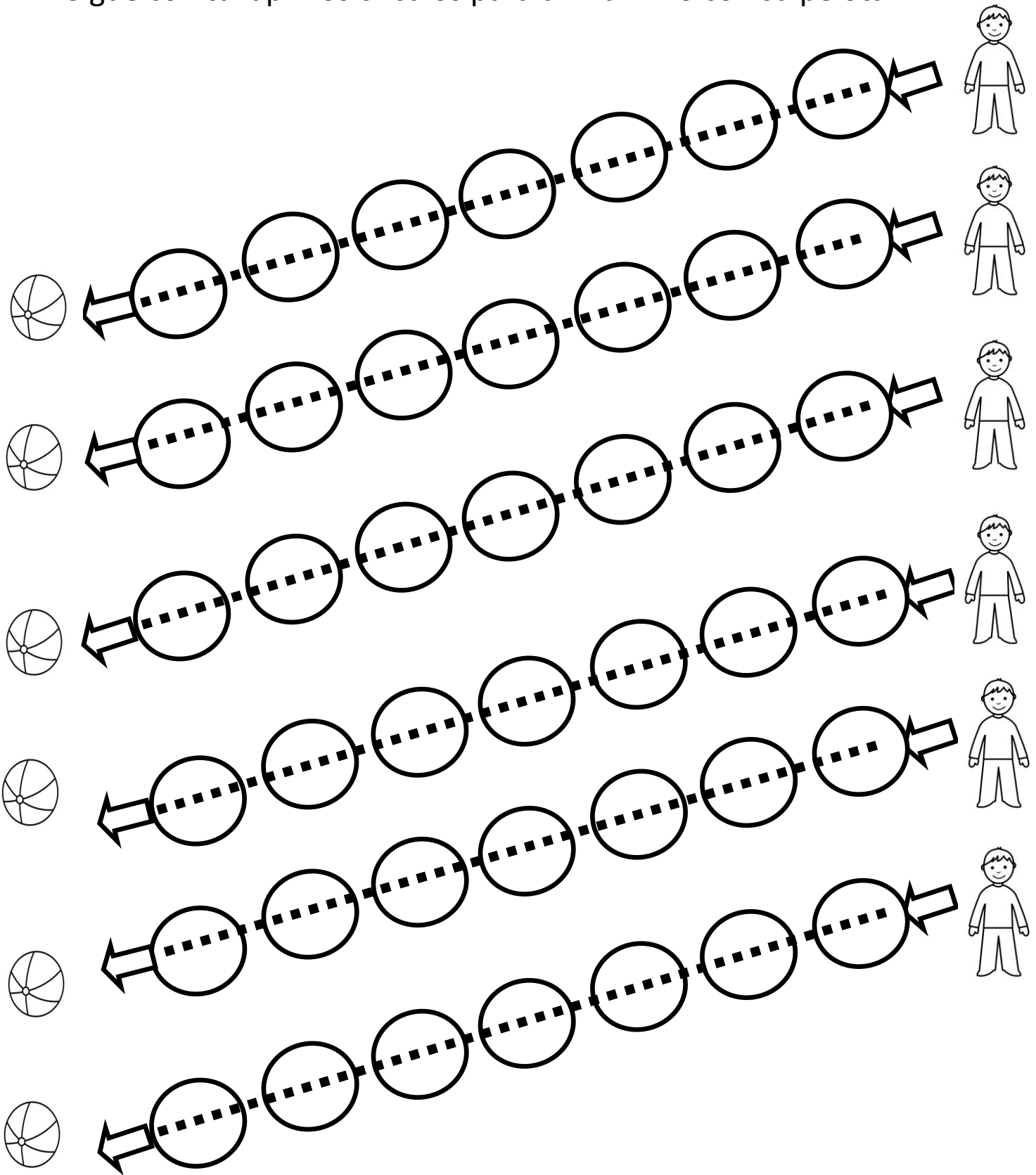

Actividades para mejorar motricidad fina

Sigue con tu lápiz los círculos para unir al niño con su pelota

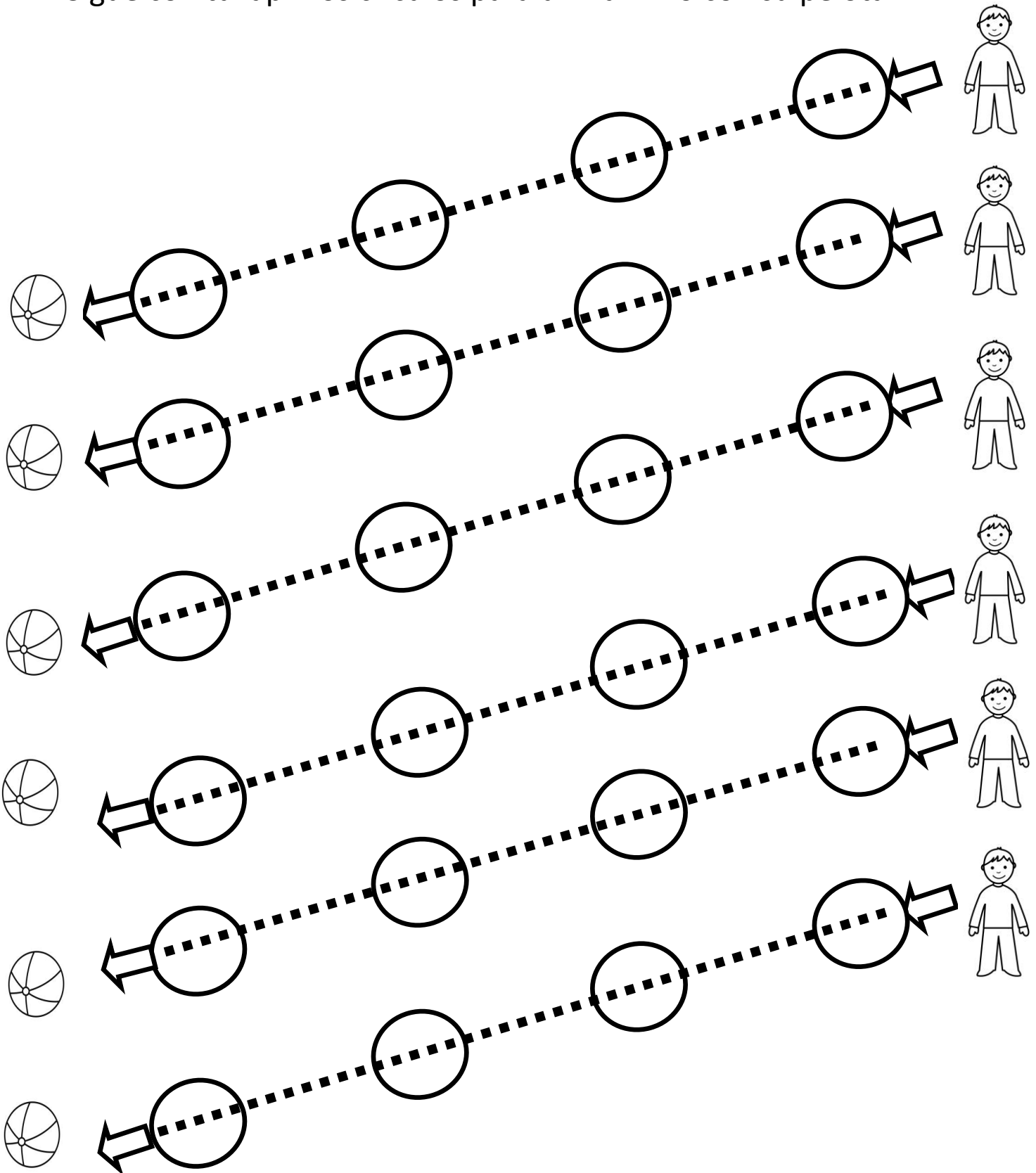

Actividades para mejorar motricidad fina

Sigue con tu lápiz los círculos para unir al niño con su pelota

The image shows a worksheet with seven rows of a zigzag path of circles. Each row starts with a ball on the left and ends with a boy on the right. The path consists of circles connected by small squares, with arrows indicating the direction of the path. The path starts with a ball on the left and ends with a boy on the right.

Actividades para mejorar motricidad fina

Sigue con tu lápiz los círculos para unir al niño con su pelota

The worksheet contains eight rows of tracing exercises. Each row consists of a ball icon on the left, a large circle with a left-pointing arrow, a dashed line connecting it to a second circle, another dashed line connecting it to a third circle, and a fourth circle with a right-pointing arrow. To the right of each row is a stick figure icon of a child. The goal is to trace the dashed lines and connect the circles to match each child with their ball.

Actividades para mejorar motricidad fina

Sigue con tu lápiz los círculos para unir al niño con su pelota

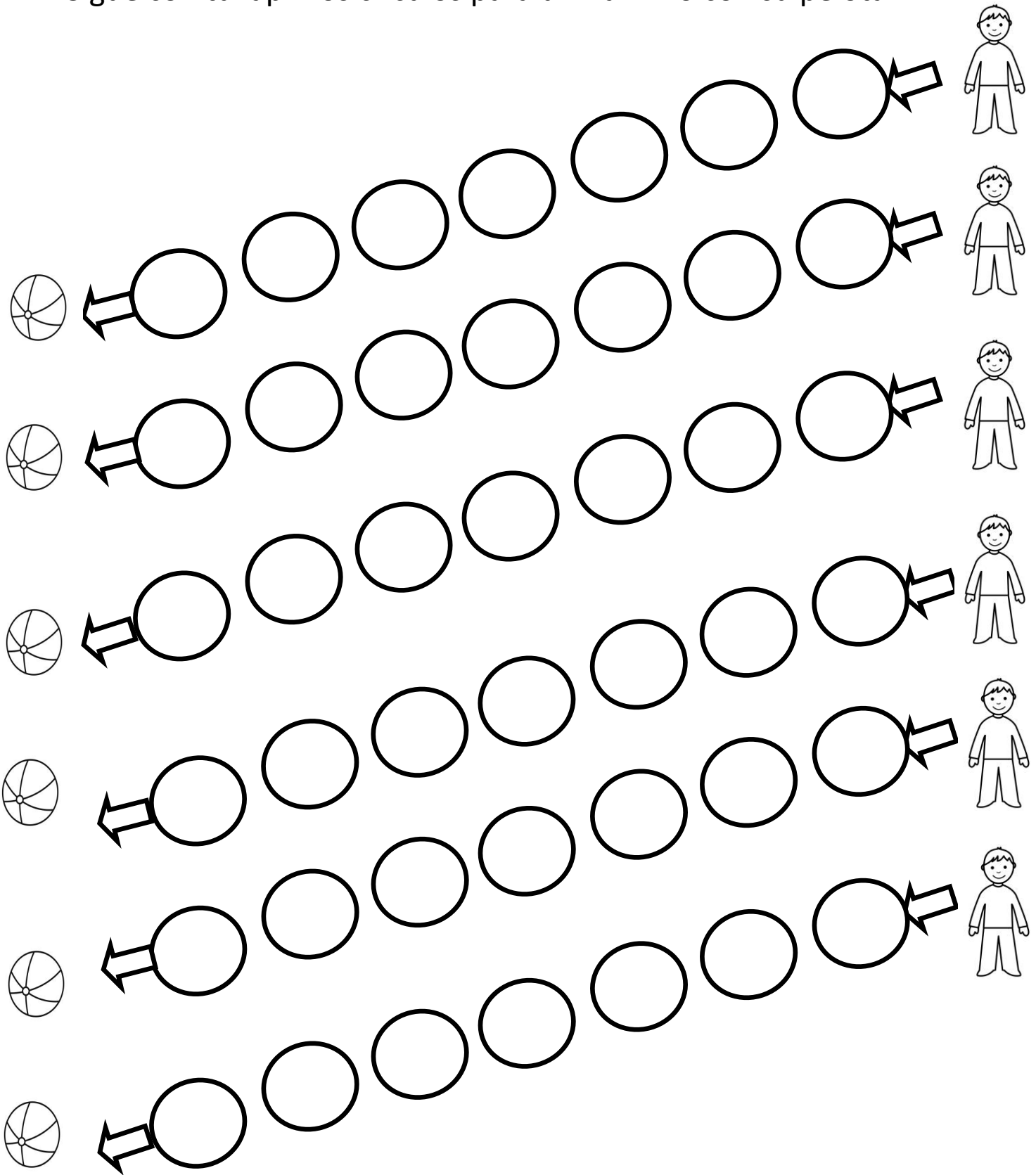

Actividades para mejorar motricidad fina

Sigue con tu lápiz los círculos para unir al niño con su pelota

The worksheet consists of a 7x4 grid of circles. The first column contains a ball icon next to a circle with an arrow pointing left. The second column contains empty circles. The third column contains empty circles. The fourth column contains a circle with an arrow pointing left next to a boy icon. The goal is to connect the circles in the second and third columns to the boy icons in the fourth column.

Actividades para mejorar motricidad fina

Sigue con tu lápiz los cuadrados para unir a la niña con su casa

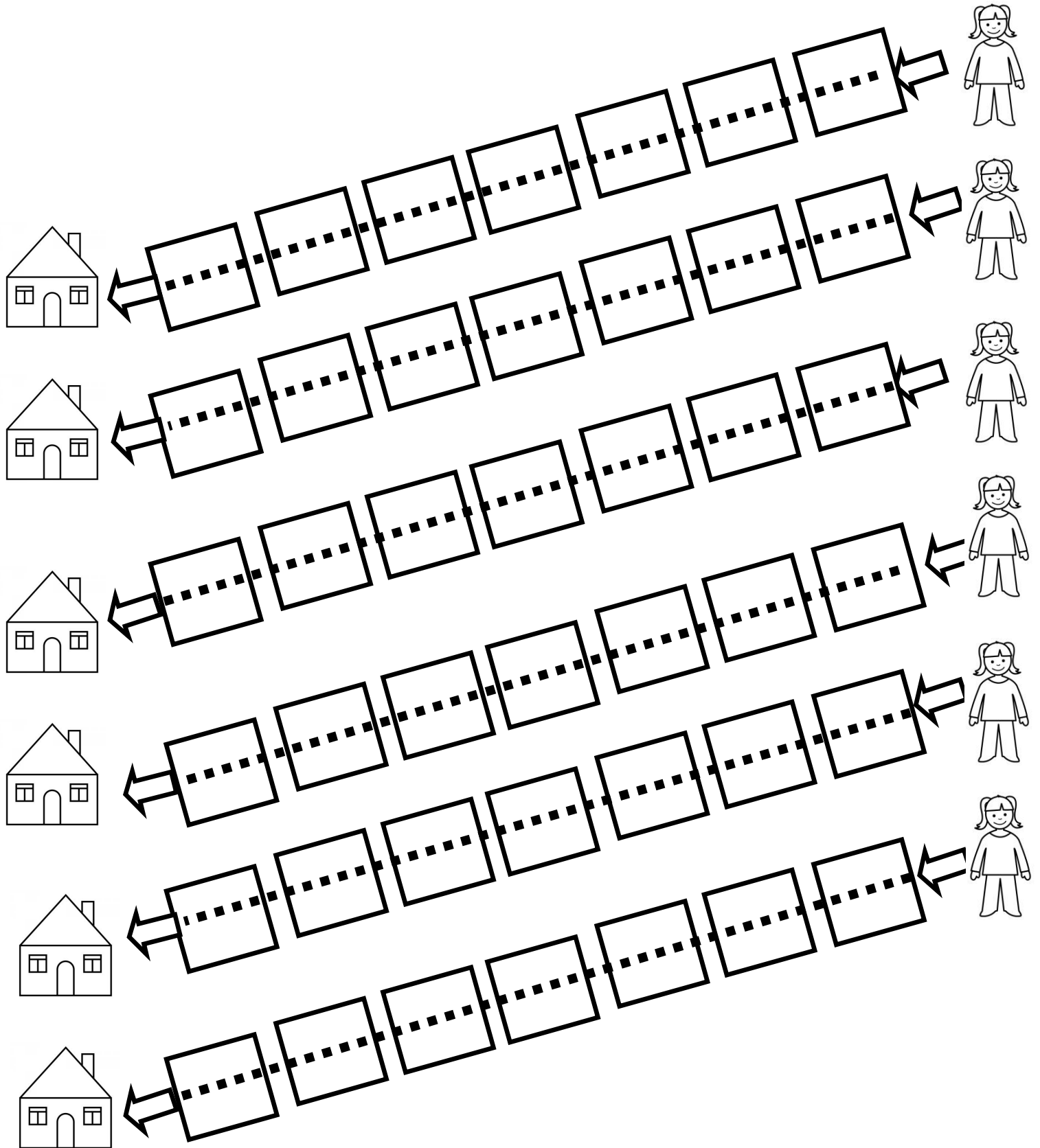

Actividades para mejorar motricidad fina

Sigue con tu lápiz los cuadrados para unir a la niña con su casa

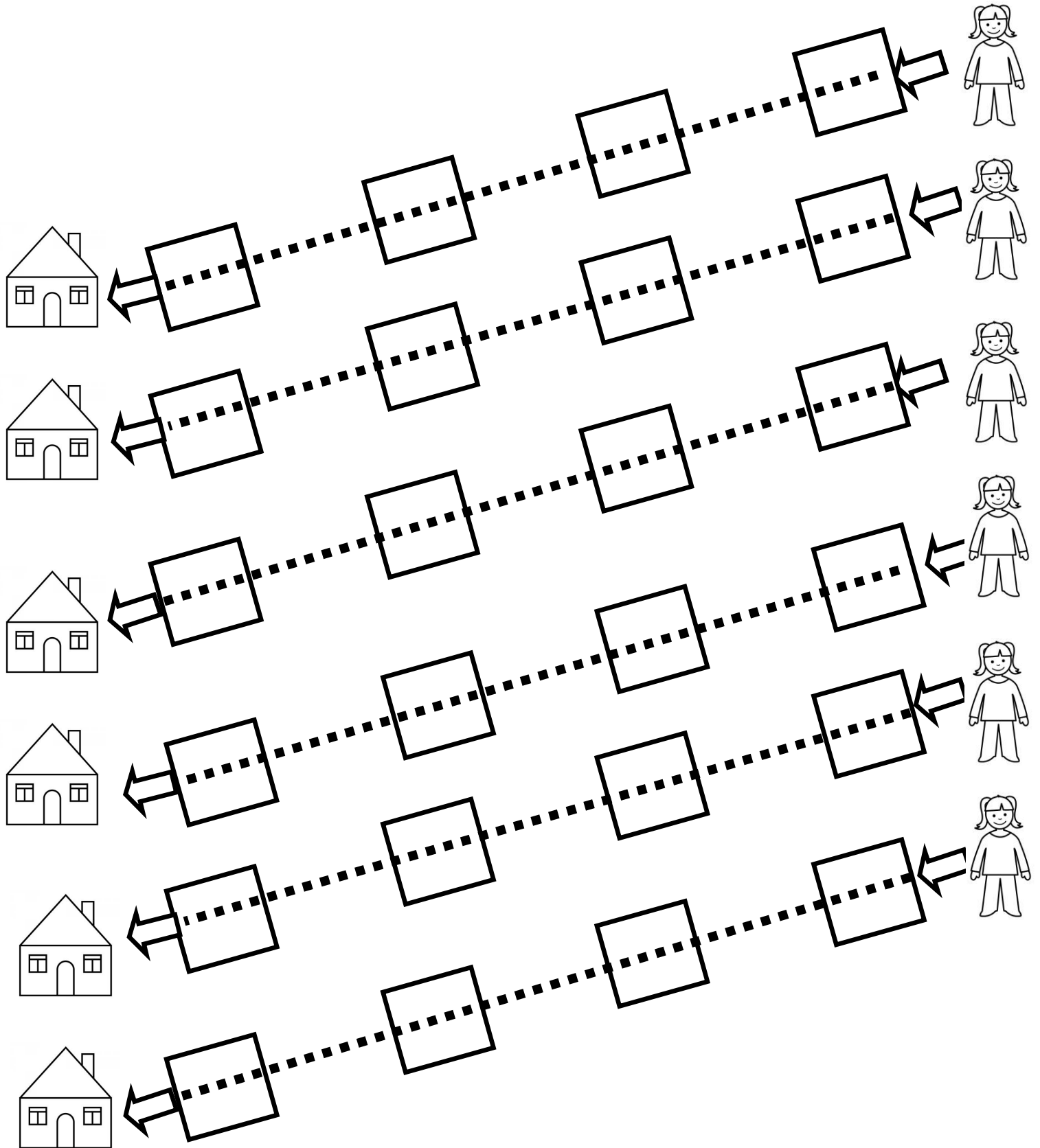

Actividades para mejorar motricidad fina

Sigue con tu lápiz los cuadrados para unir a la niña con su casa

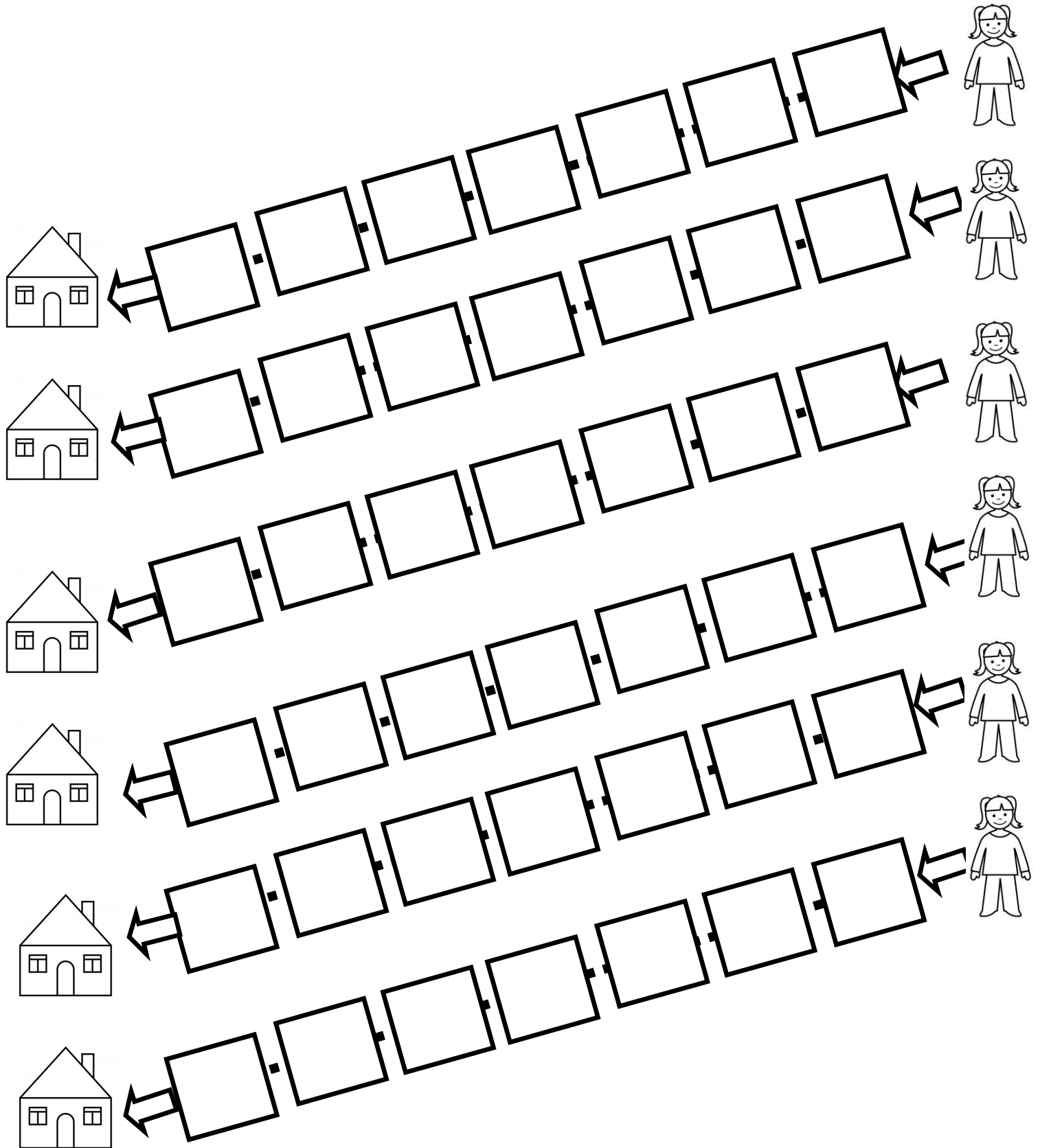

Actividades para mejorar motricidad fina

Sigue con tu lápiz los cuadrados para unir a la niña con su casa

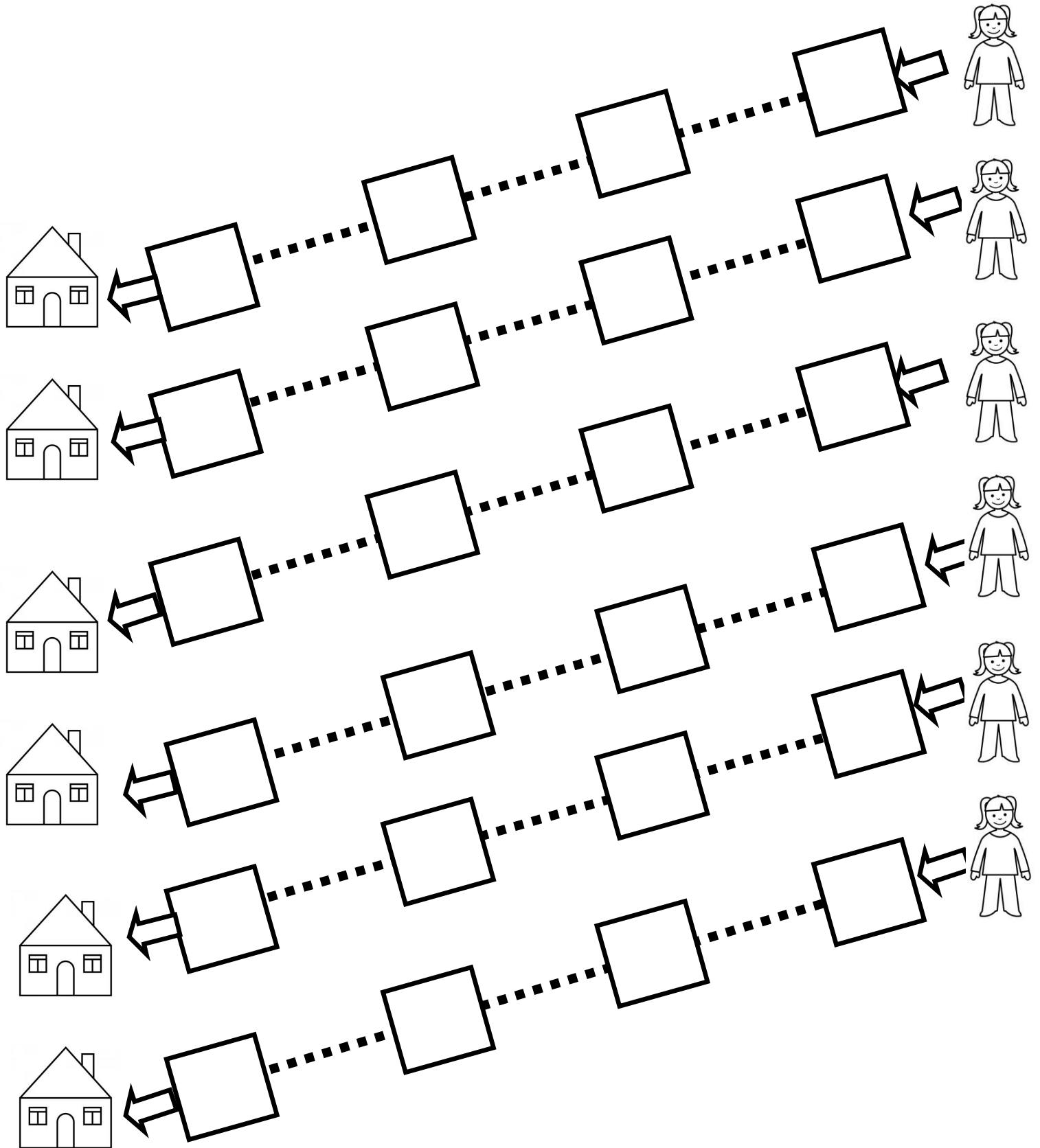

Actividades para mejorar motricidad fina

Sigue con tu lápiz los cuadrados para unir a la niña con su casa

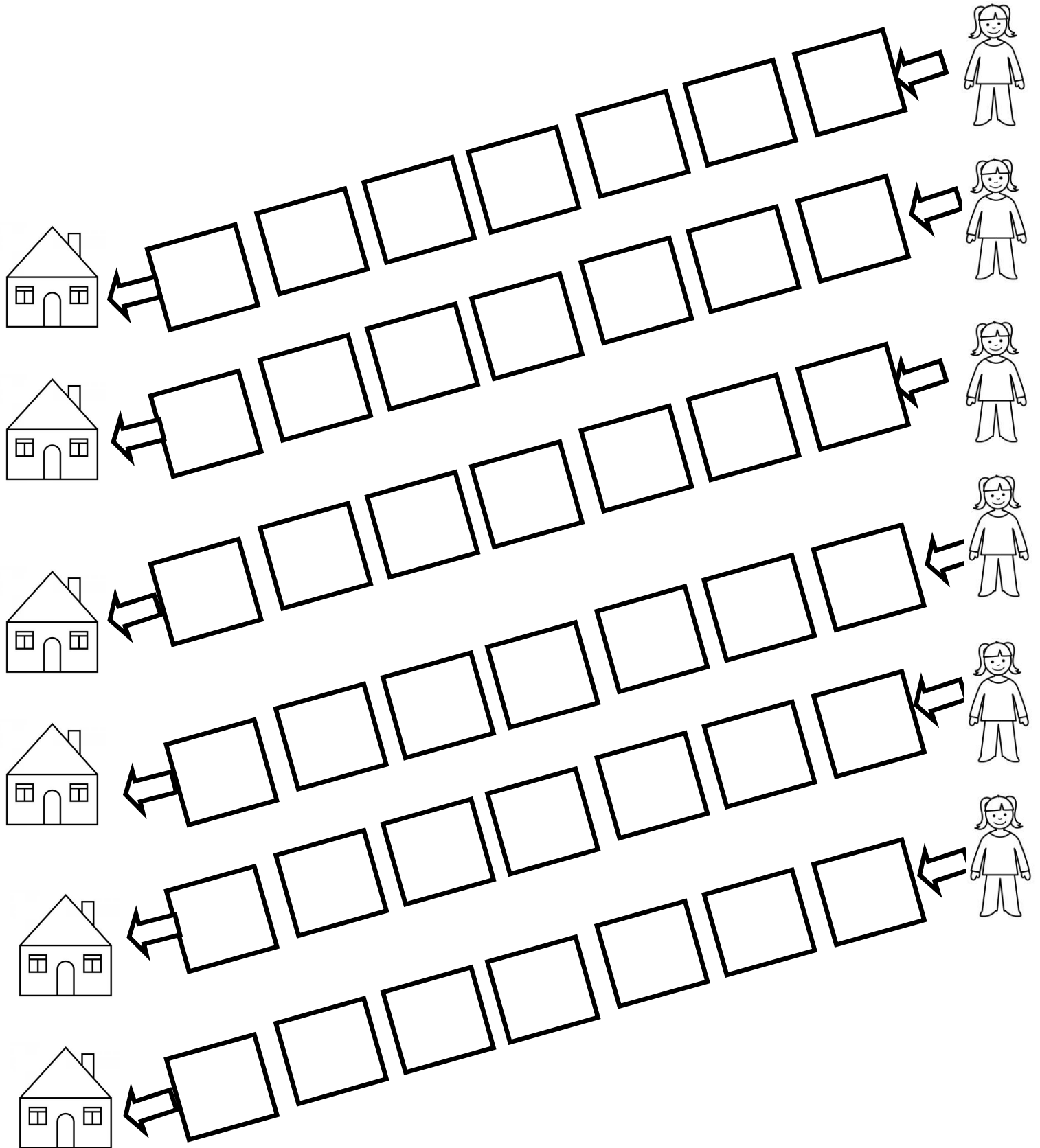

Actividades para mejorar motricidad fina

Sigue con tu lápiz los cuadrados para unir a la niña con su casa

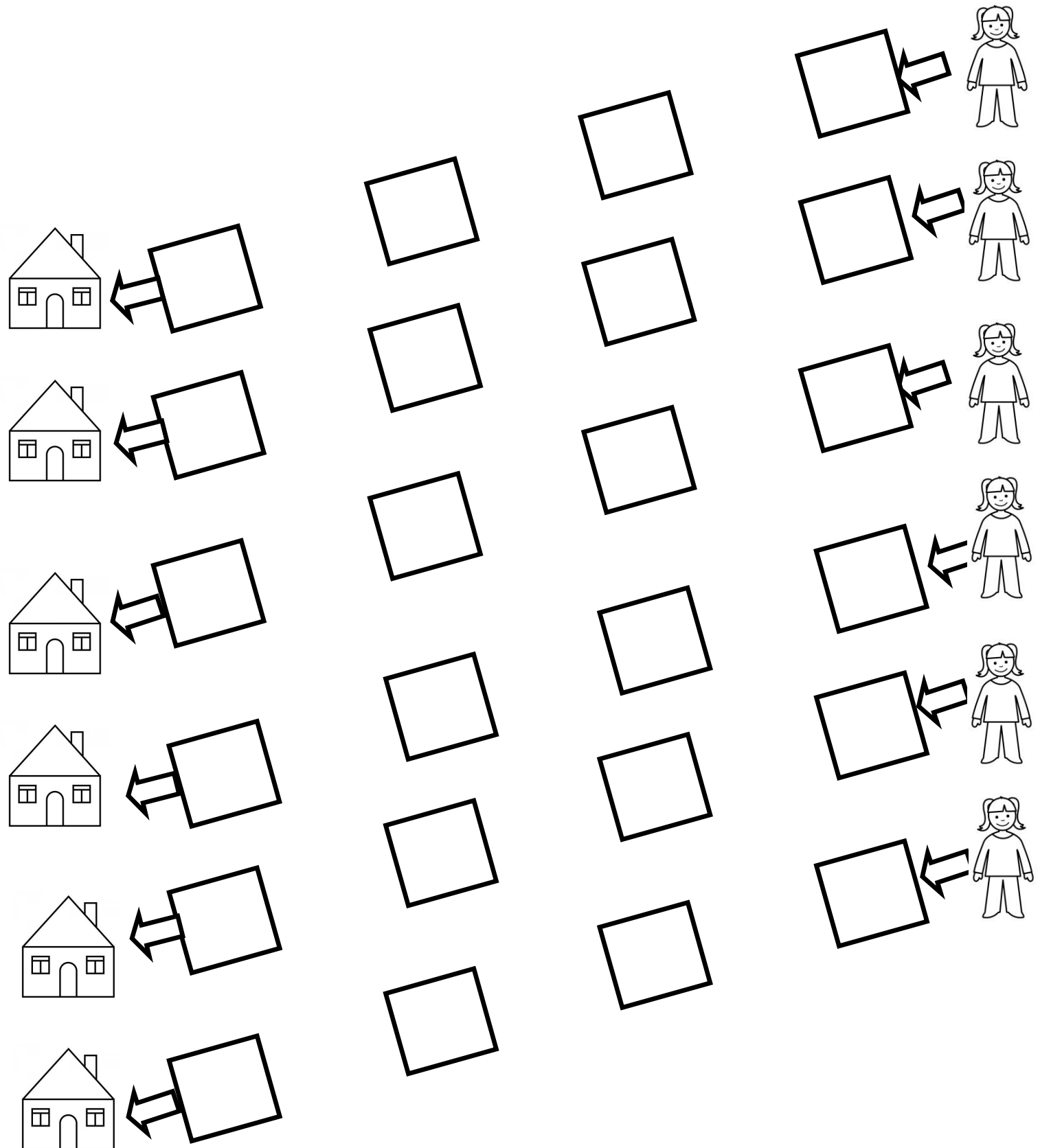

Actividades para mejorar motricidad fina

Sigue con tu lápiz las estrellitas para ir desde el sol a la tierra

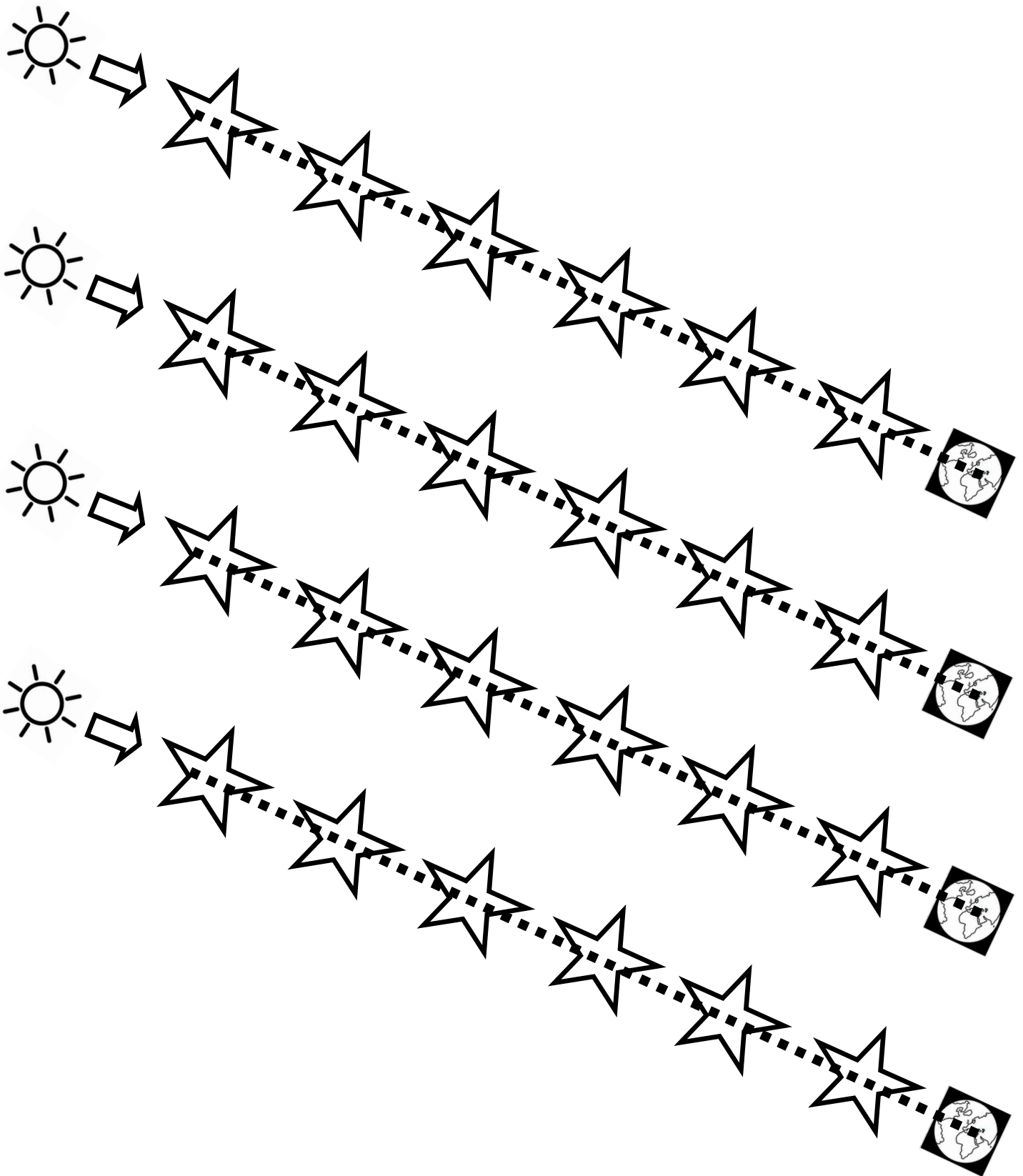

Actividades para mejorar motricidad fina

Sigue con tu lápiz las estrellitas para ir desde el sol a la tierra

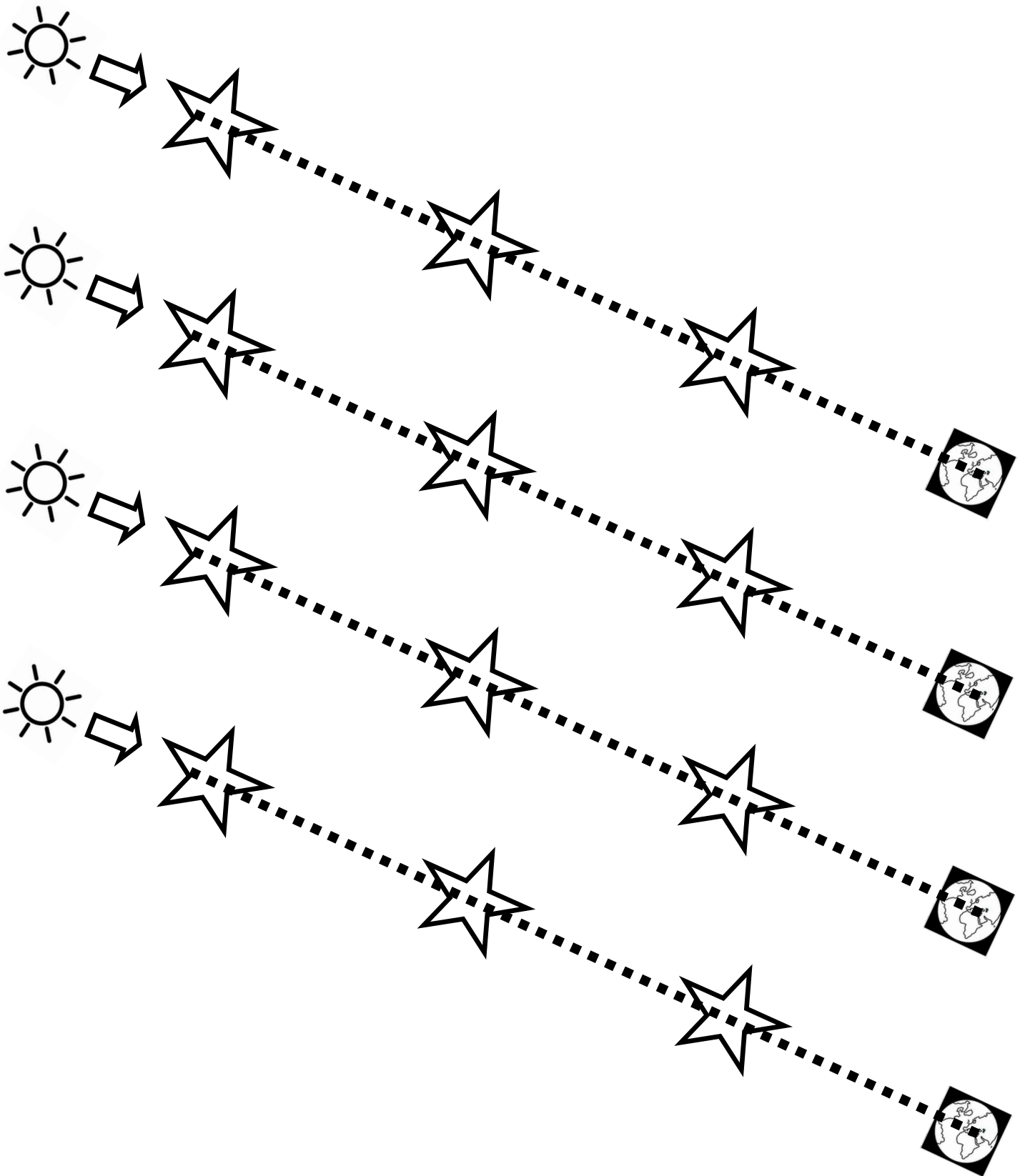

Actividades para mejorar motricidad fina

Sigue con tu lápiz las estrellitas para ir desde el sol a la tierra

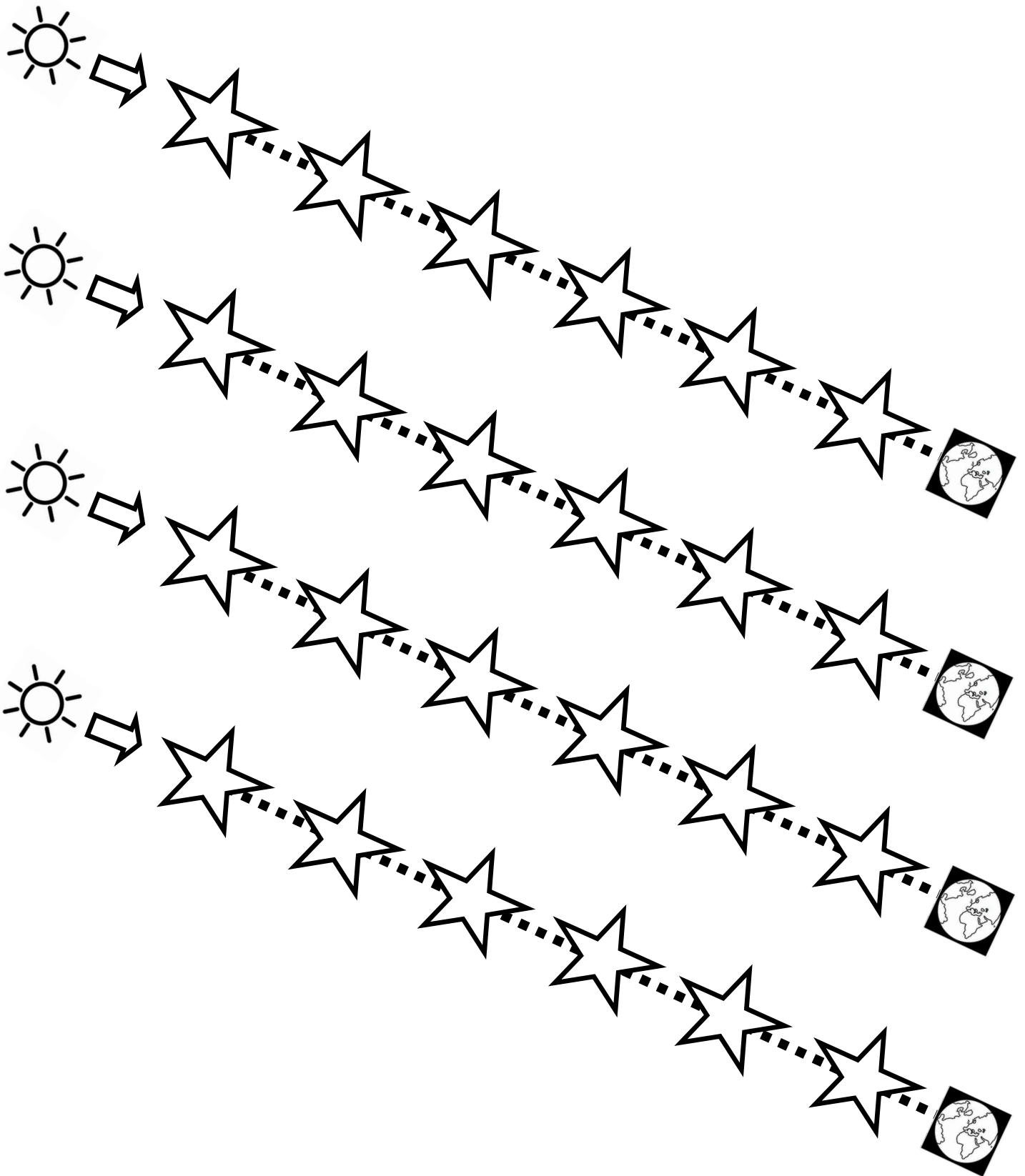

Actividades para mejorar motricidad fina

Sigue con tu lápiz las estrellitas para ir desde el sol a la tierra

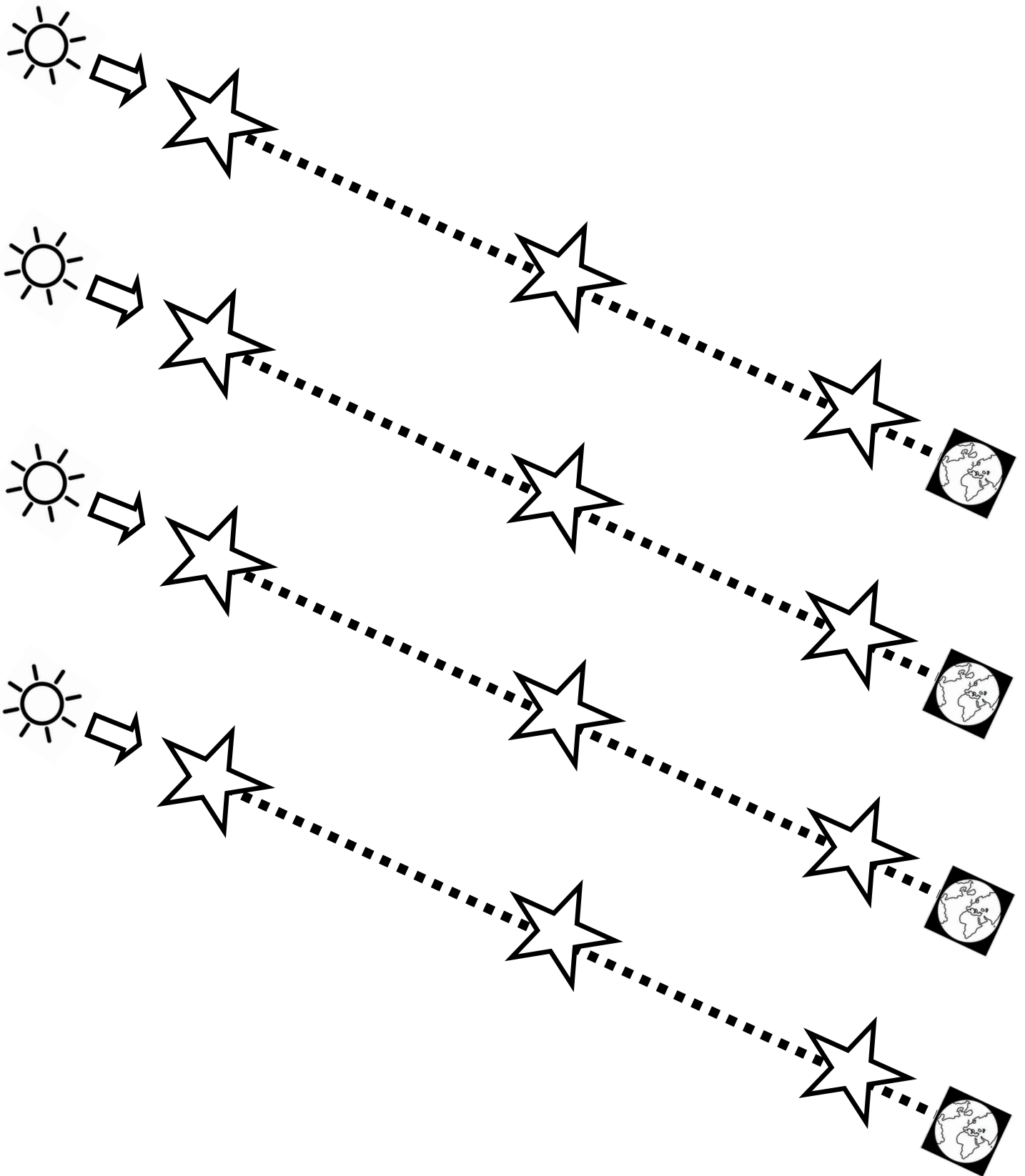

Actividades para mejorar motricidad fina

Sigue con tu lápiz las estrellitas para ir desde el sol a la tierra



Actividades para mejorar motricidad fina

Sigue con tu lápiz las estrellitas para ir desde el sol a la tierra

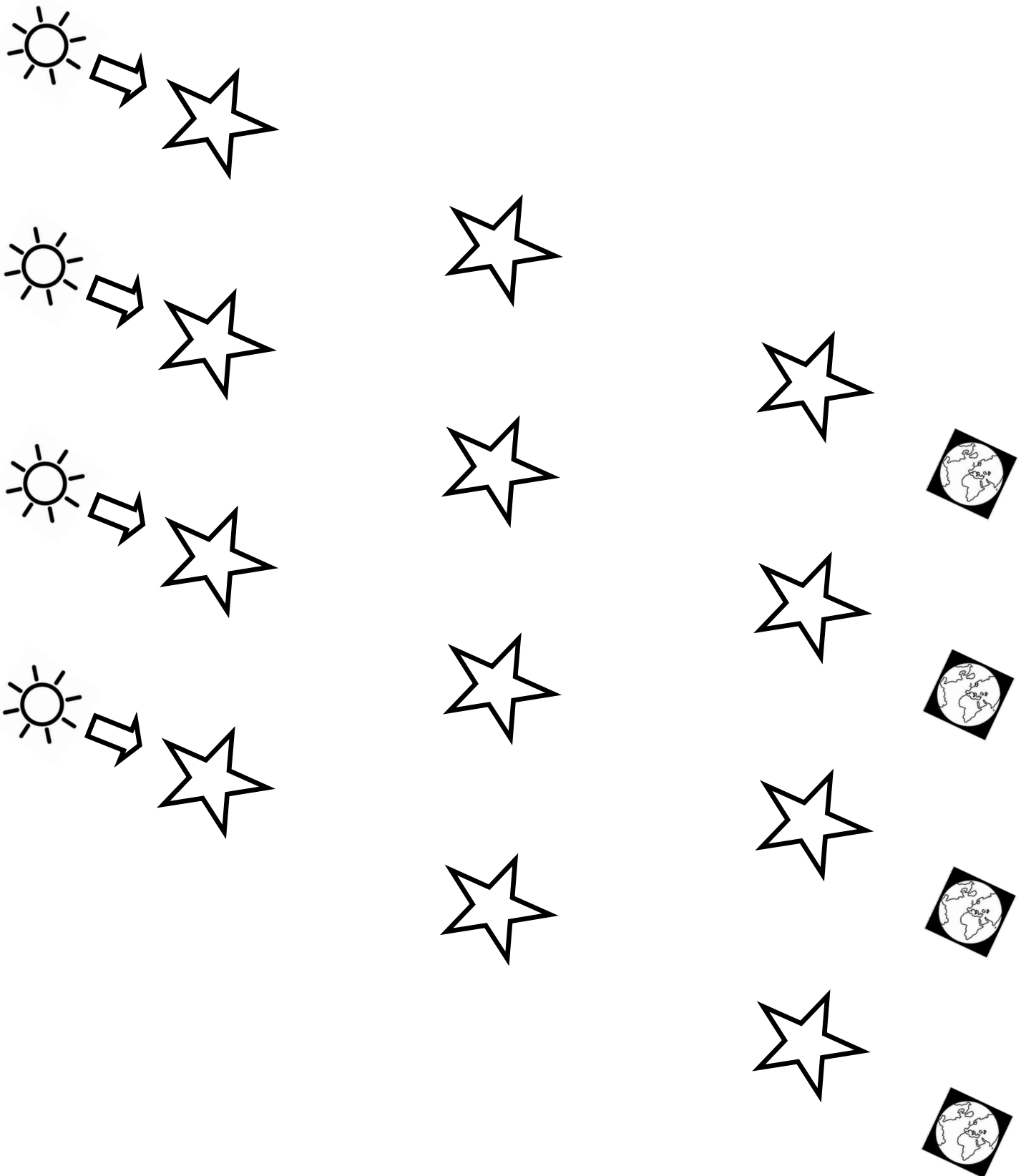

Actividades para mejorar motricidad fina

Sigue con tu lápiz los corazones para unir a la mama y a su bebe

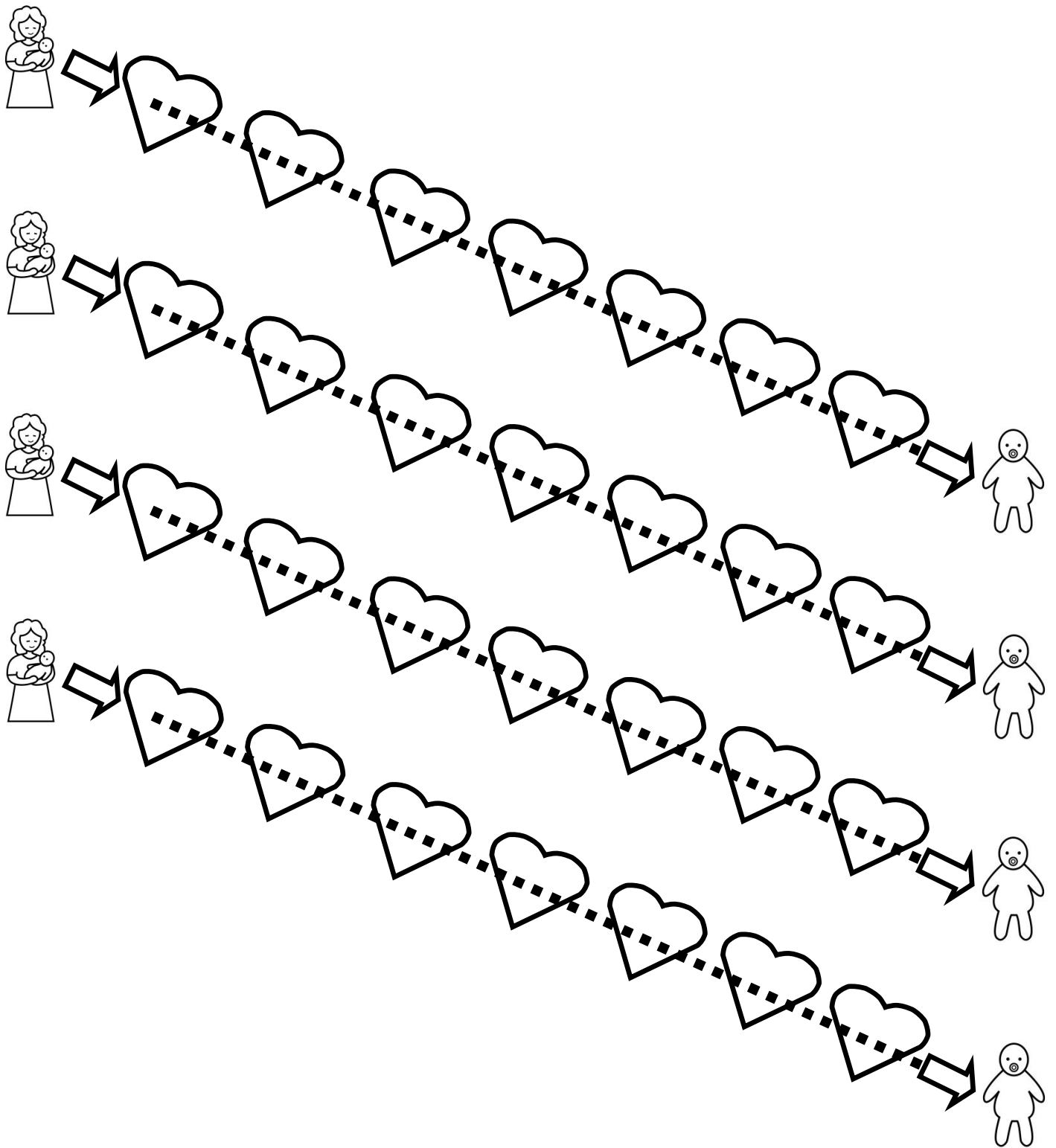

Actividades para mejorar motricidad fina

Sigue con tu lápiz los corazones para unir a la mama y a su bebe

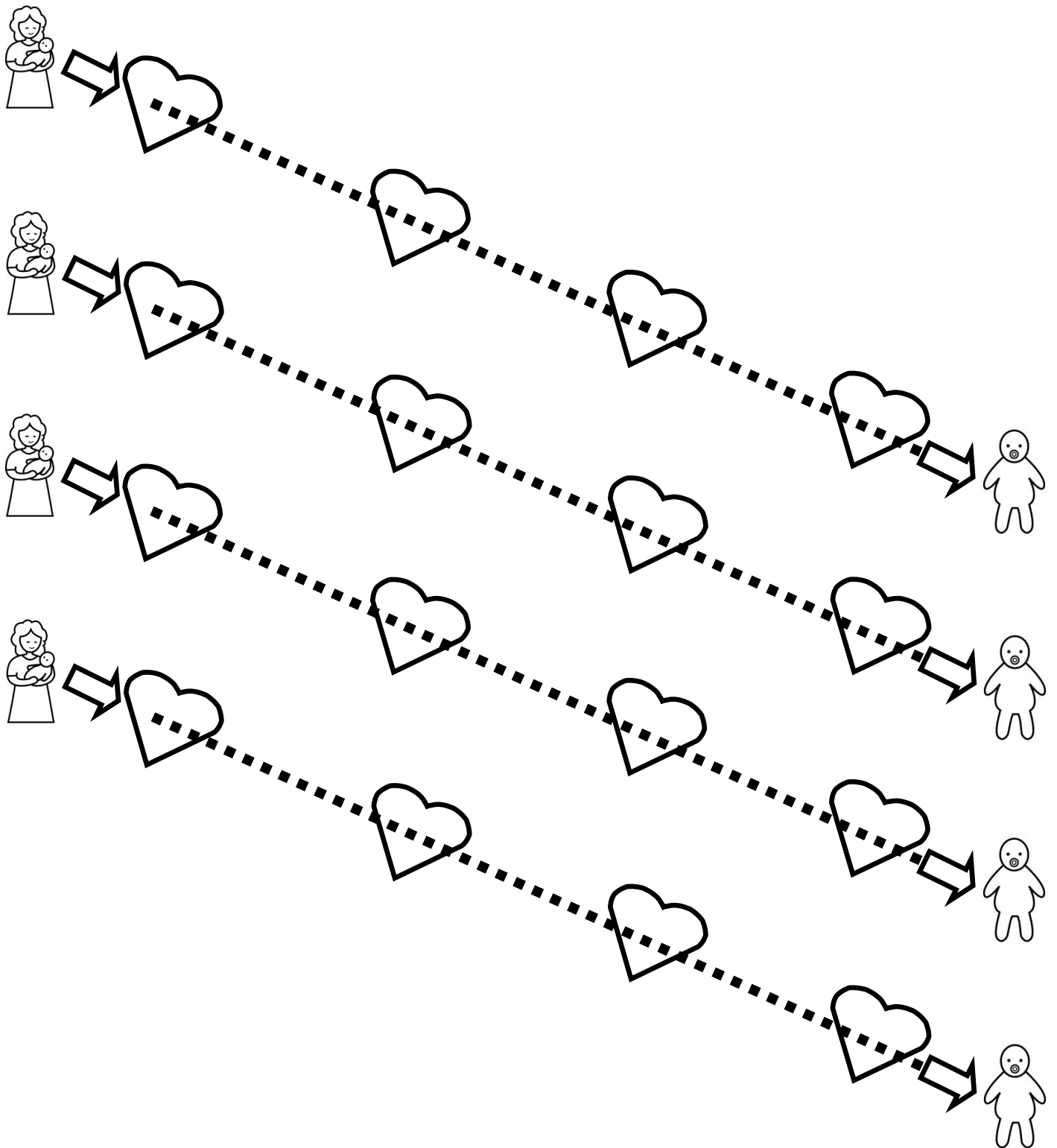

Actividades para mejorar motricidad fina

Sigue con tu lápiz los corazones para unir a la mama y a su bebe

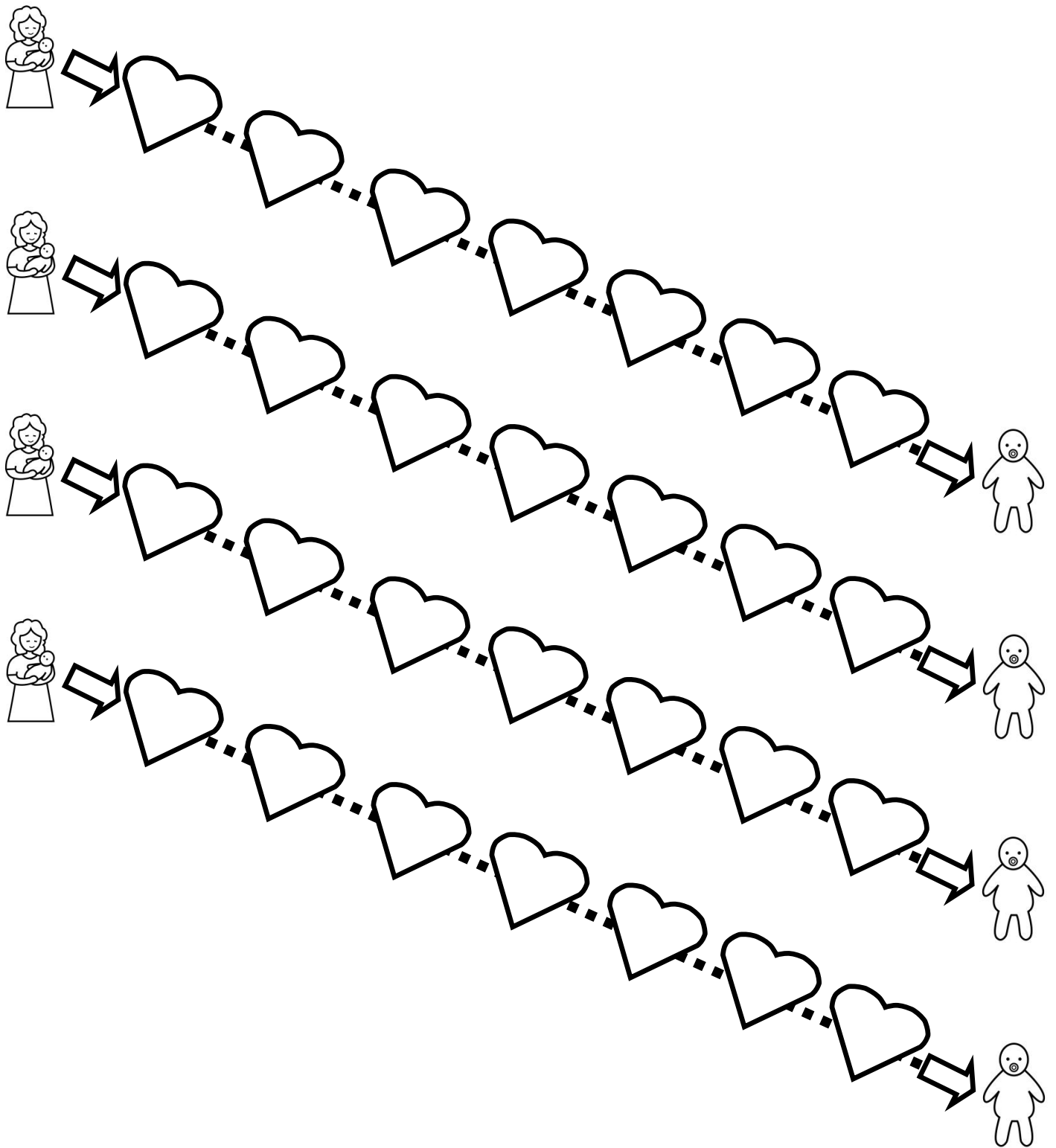

Actividades para mejorar motricidad fina

Sigue con tu lápiz los corazones para unir a la mama y a su bebe

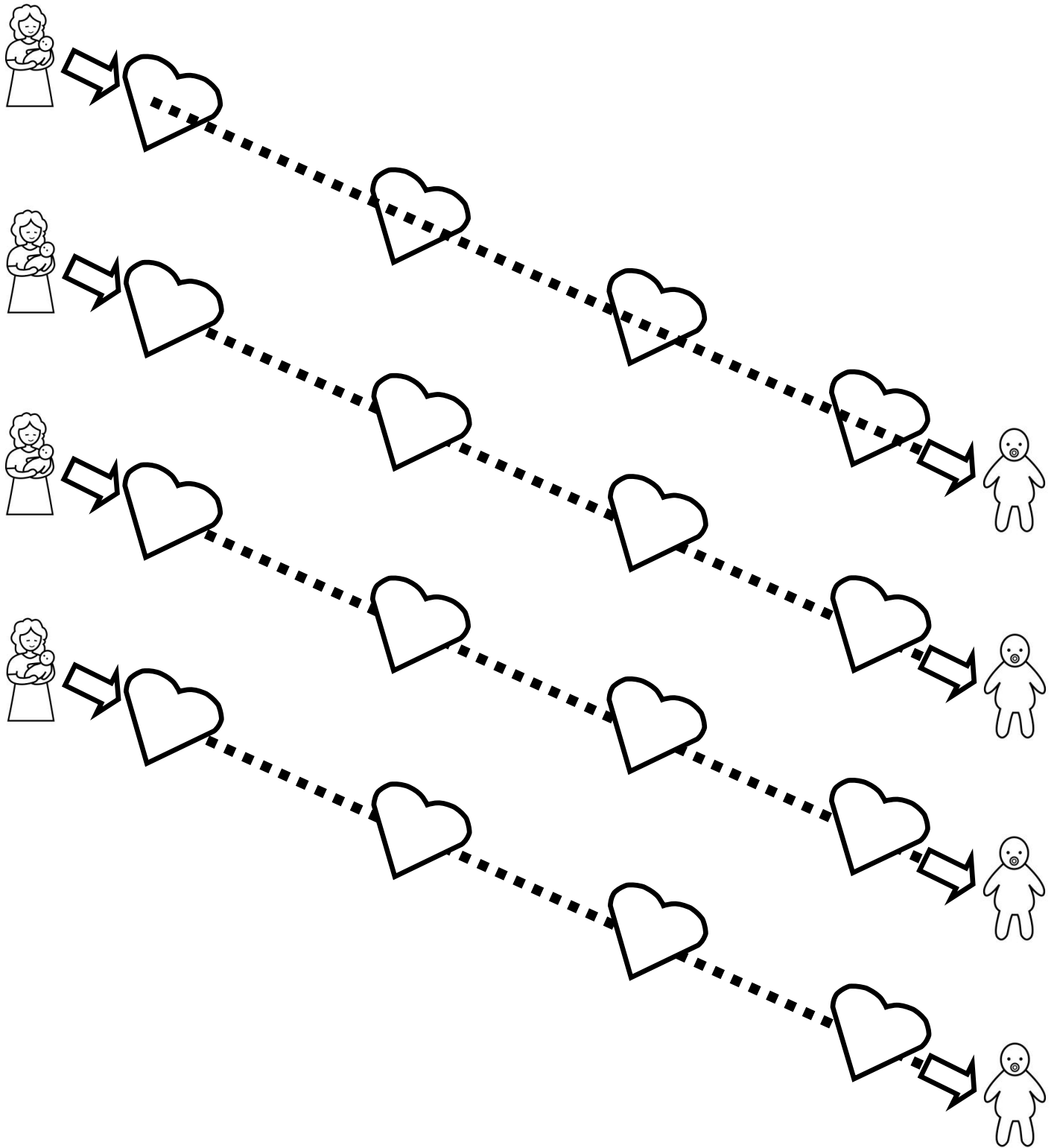

Actividades para mejorar motricidad fina

Sigue con tu lápiz los corazones para unir a la mama y a su bebe

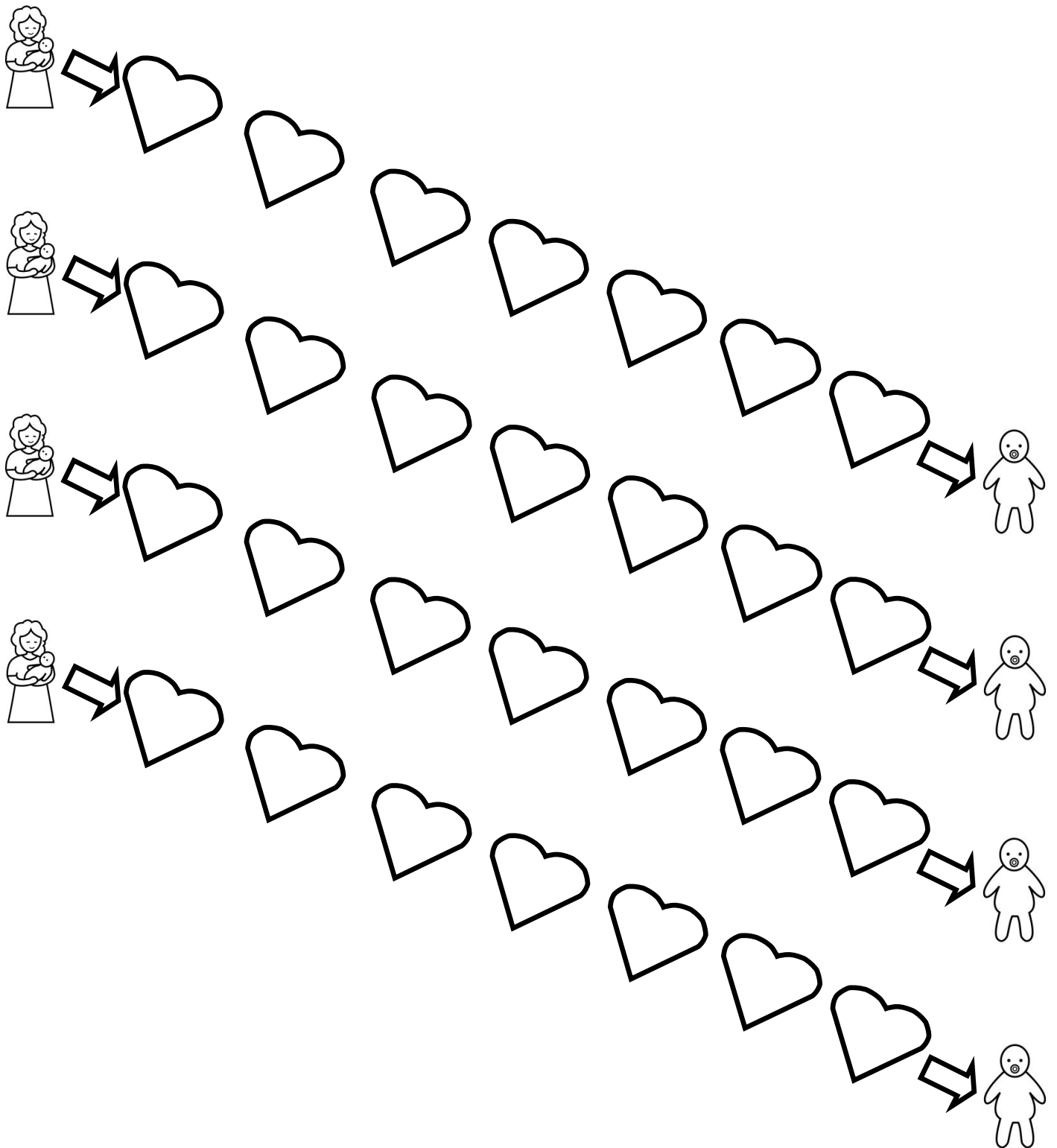

Actividades para mejorar motricidad fina

Sigue con tu lápiz los corazones para unir a la mama y a su bebe

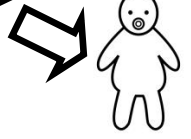
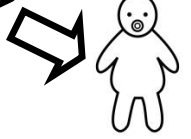
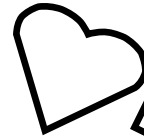
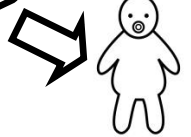
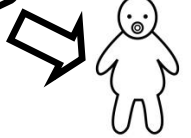
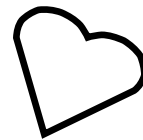
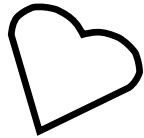
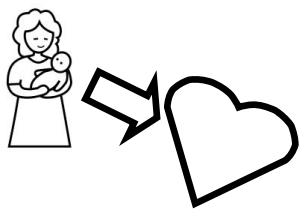
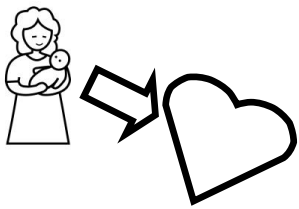
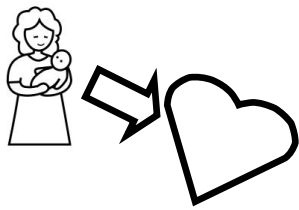
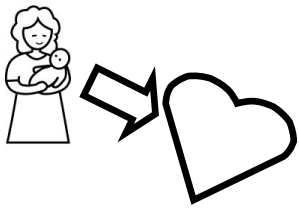

Actividades para mejorar motricidad fina

Sigue con tu lápiz las caras para unir al niño con su amiga

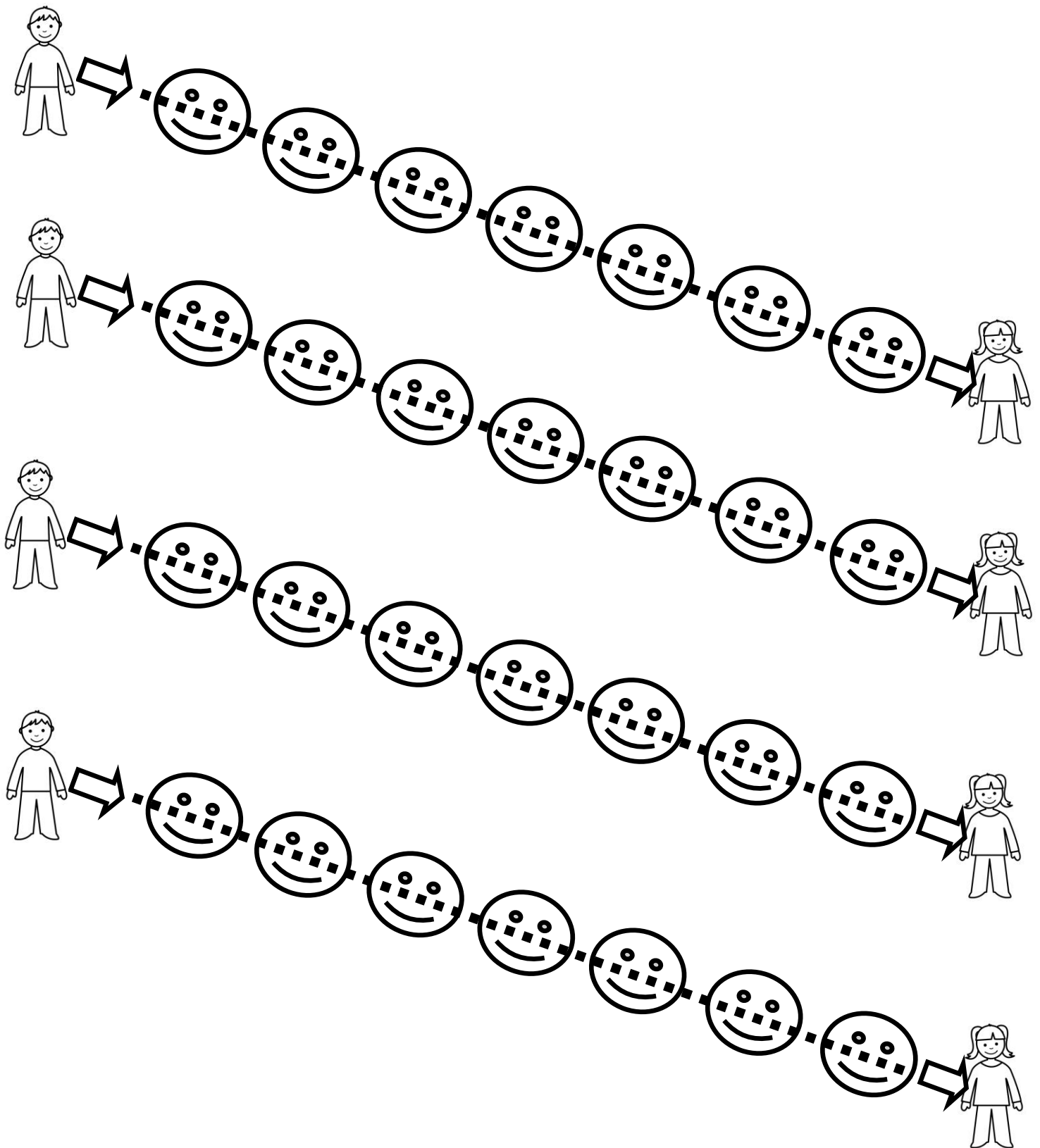

Actividades para mejorar motricidad fina

Sigue con tu lápiz las caras para unir al niño con su amiga

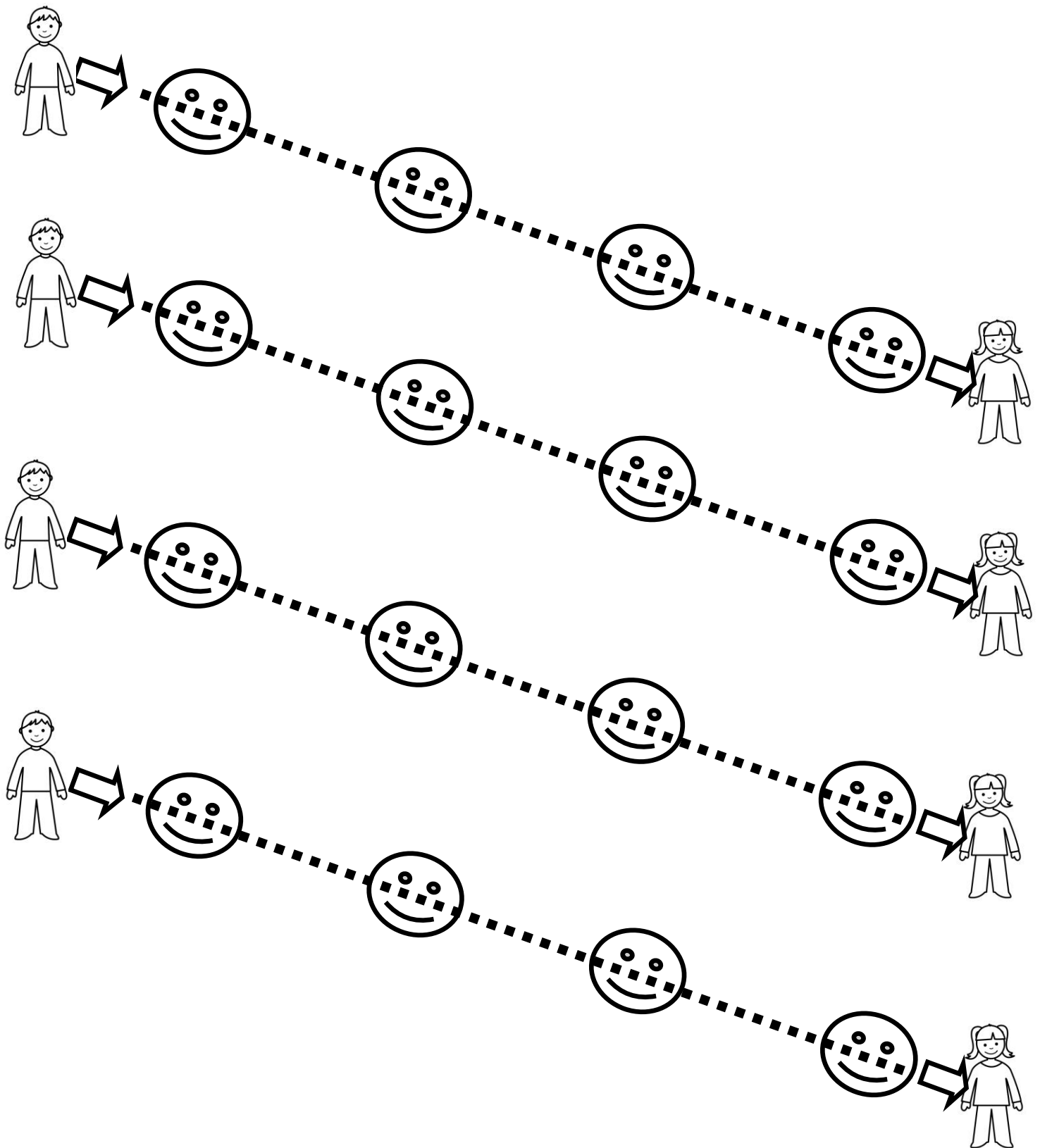

Actividades para mejorar motricidad fina

Sigue con tu lápiz las caras para unir al niño con su amiga

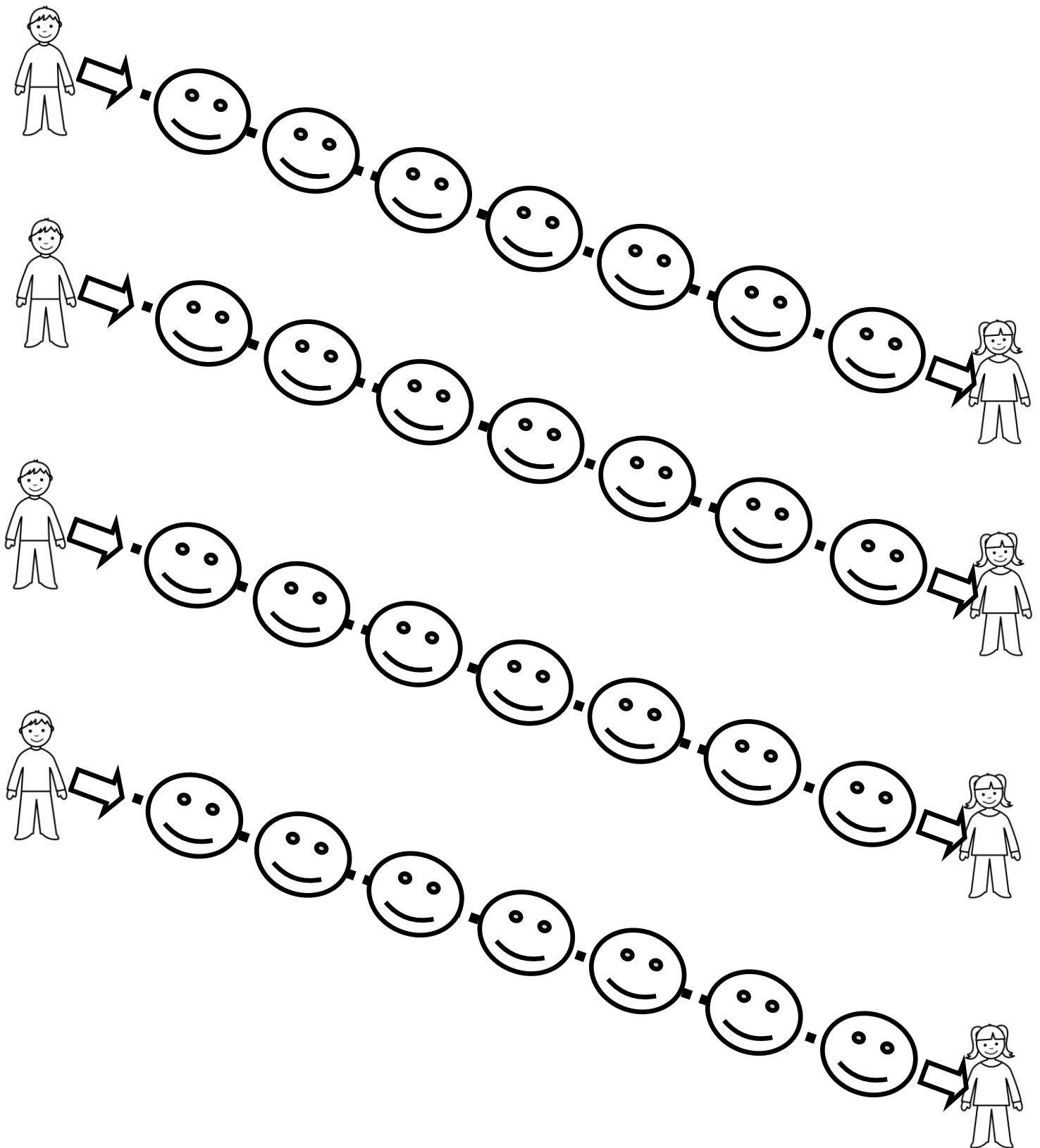

Actividades para mejorar motricidad fina

Sigue con tu lápiz las caras para unir al niño con su amiga

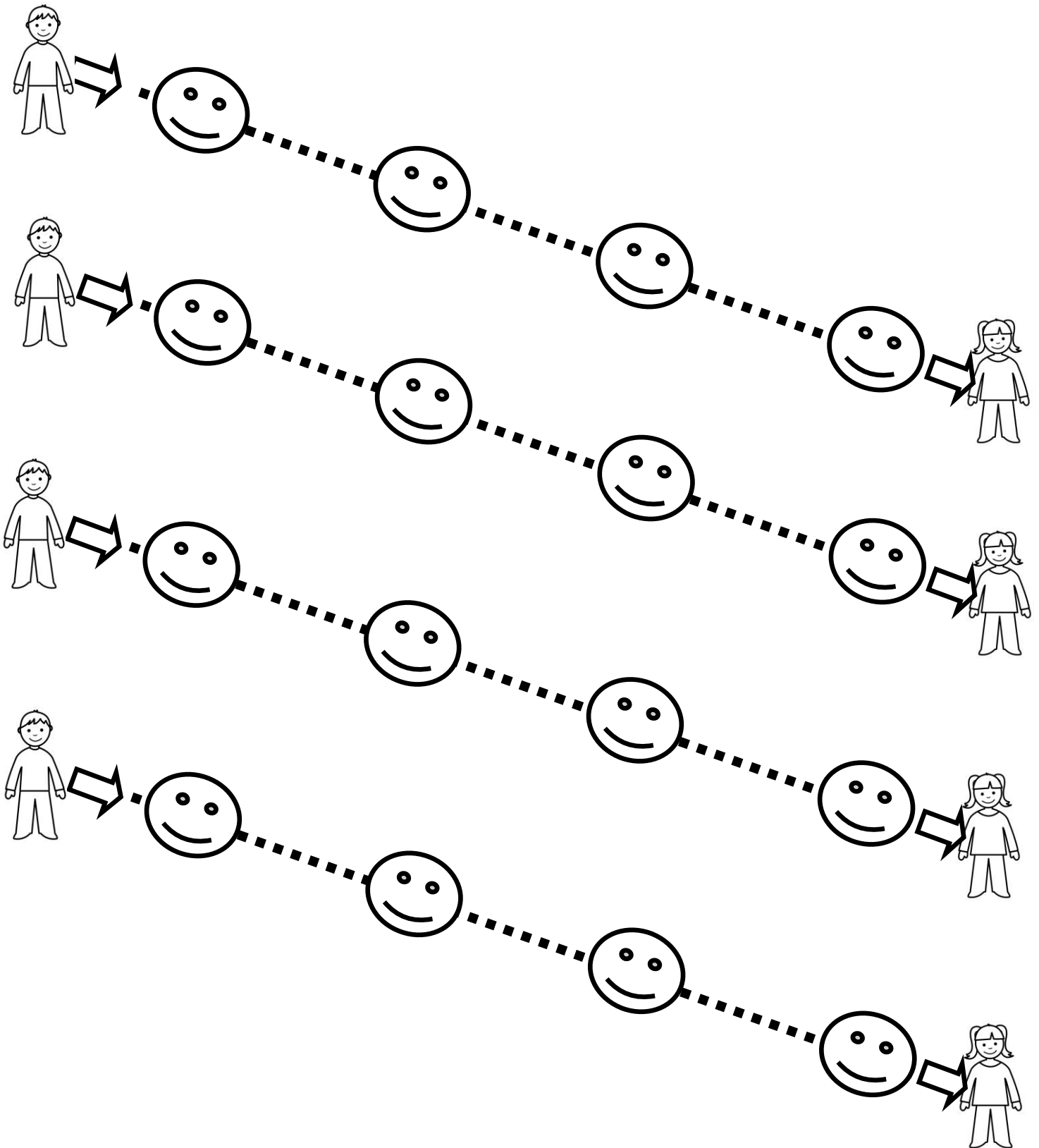

Actividades para mejorar motricidad fina

Sigue con tu lápiz las caras para unir al niño con su amiga

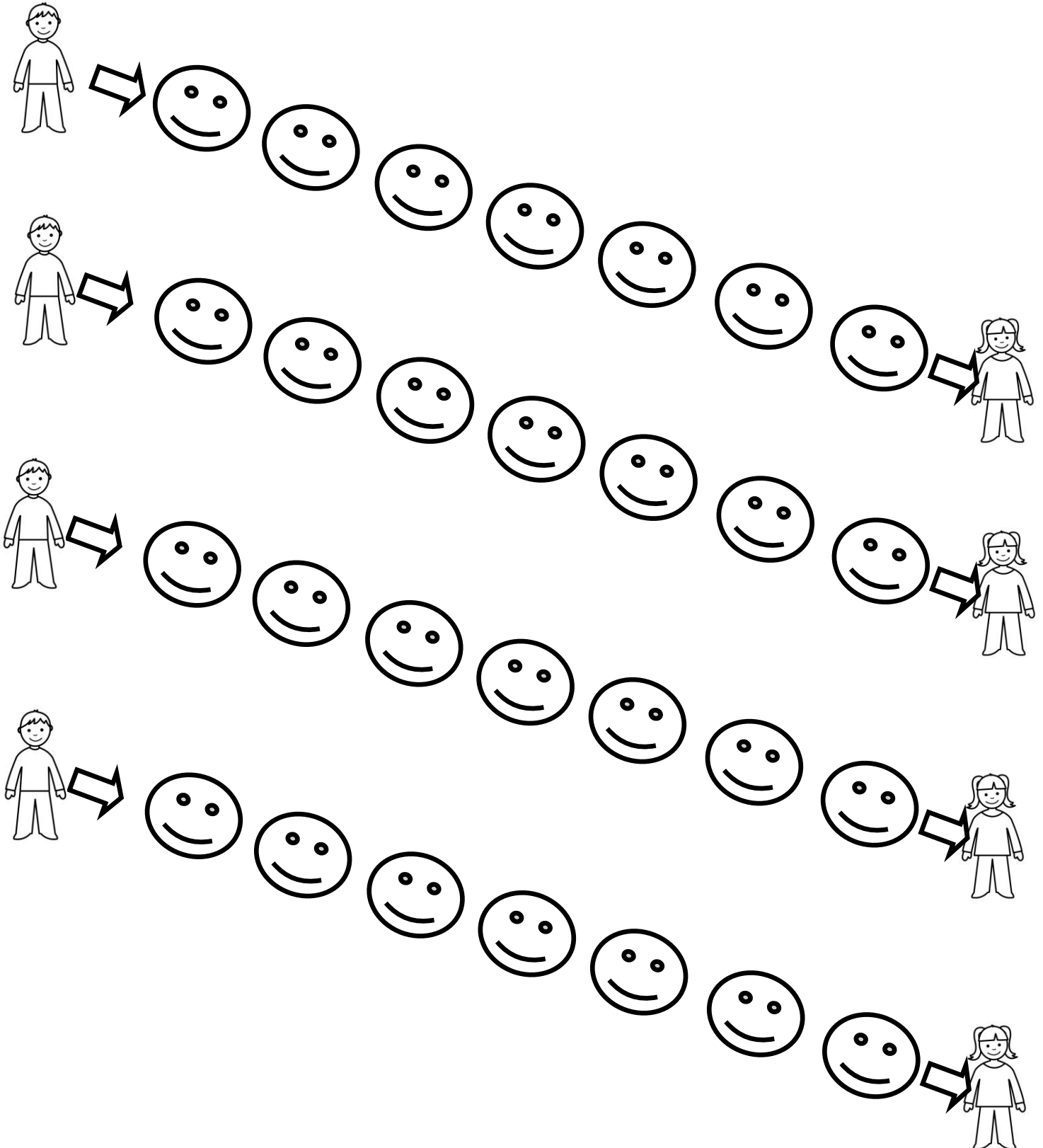

Actividades para mejorar motricidad fina

Sigue con tu lápiz las caras para unir al niño con su amiga

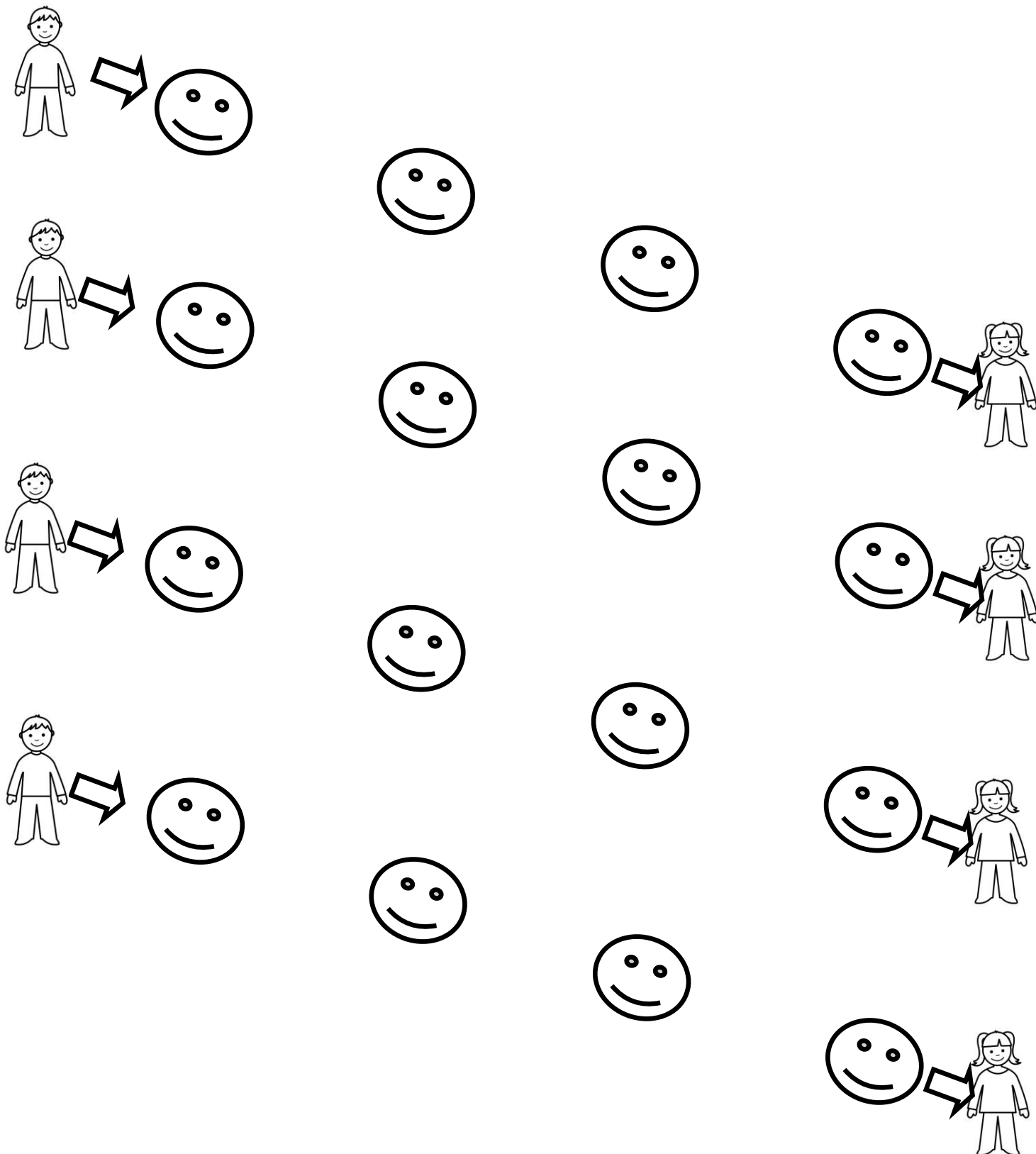

Actividades para mejorar motricidad fina

Sigue con tu lápiz los círculos para unir al niño con su pelota

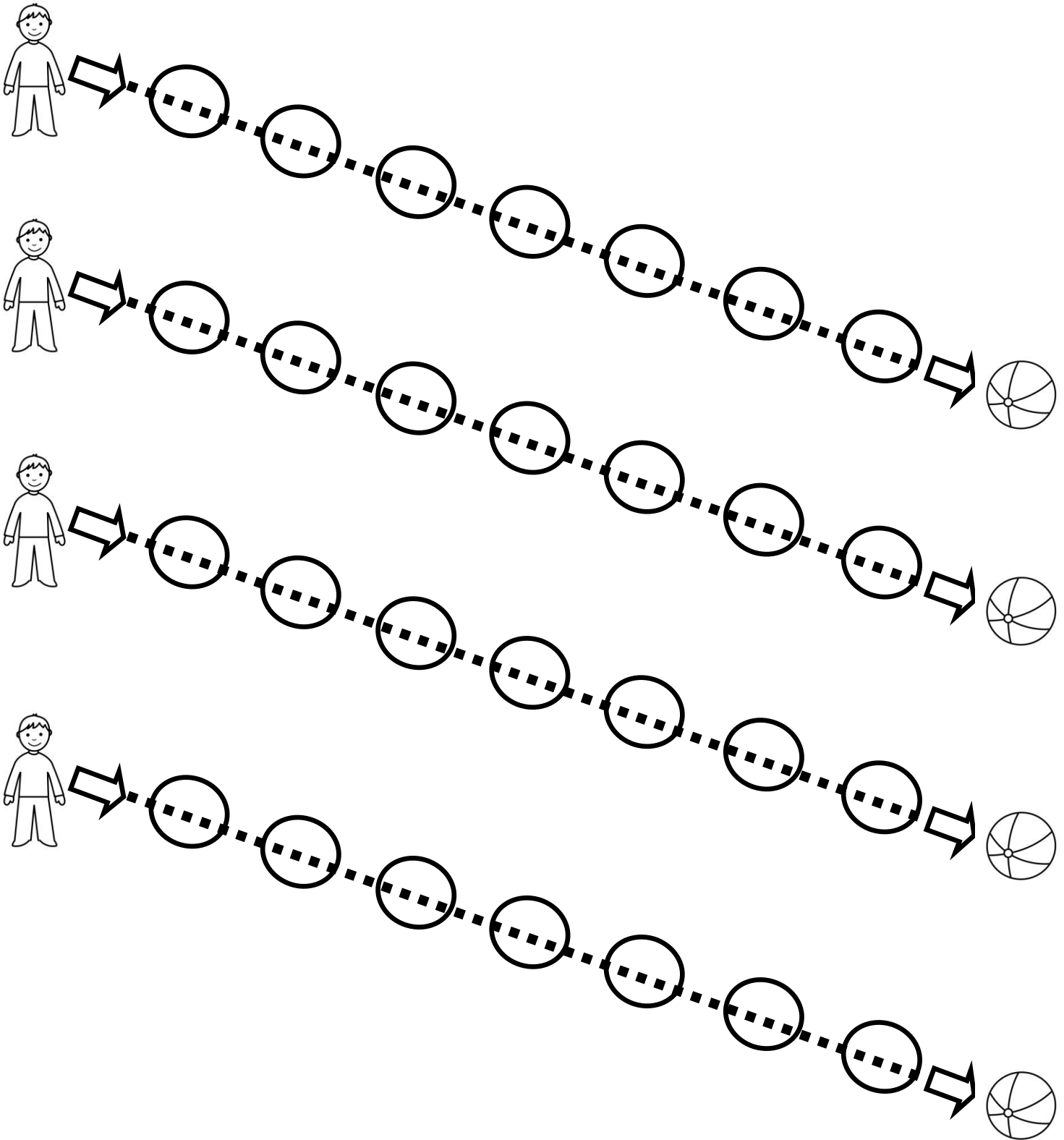

Actividades para mejorar motricidad fina

Sigue con tu lápiz los círculos para unir al niño con su pelota

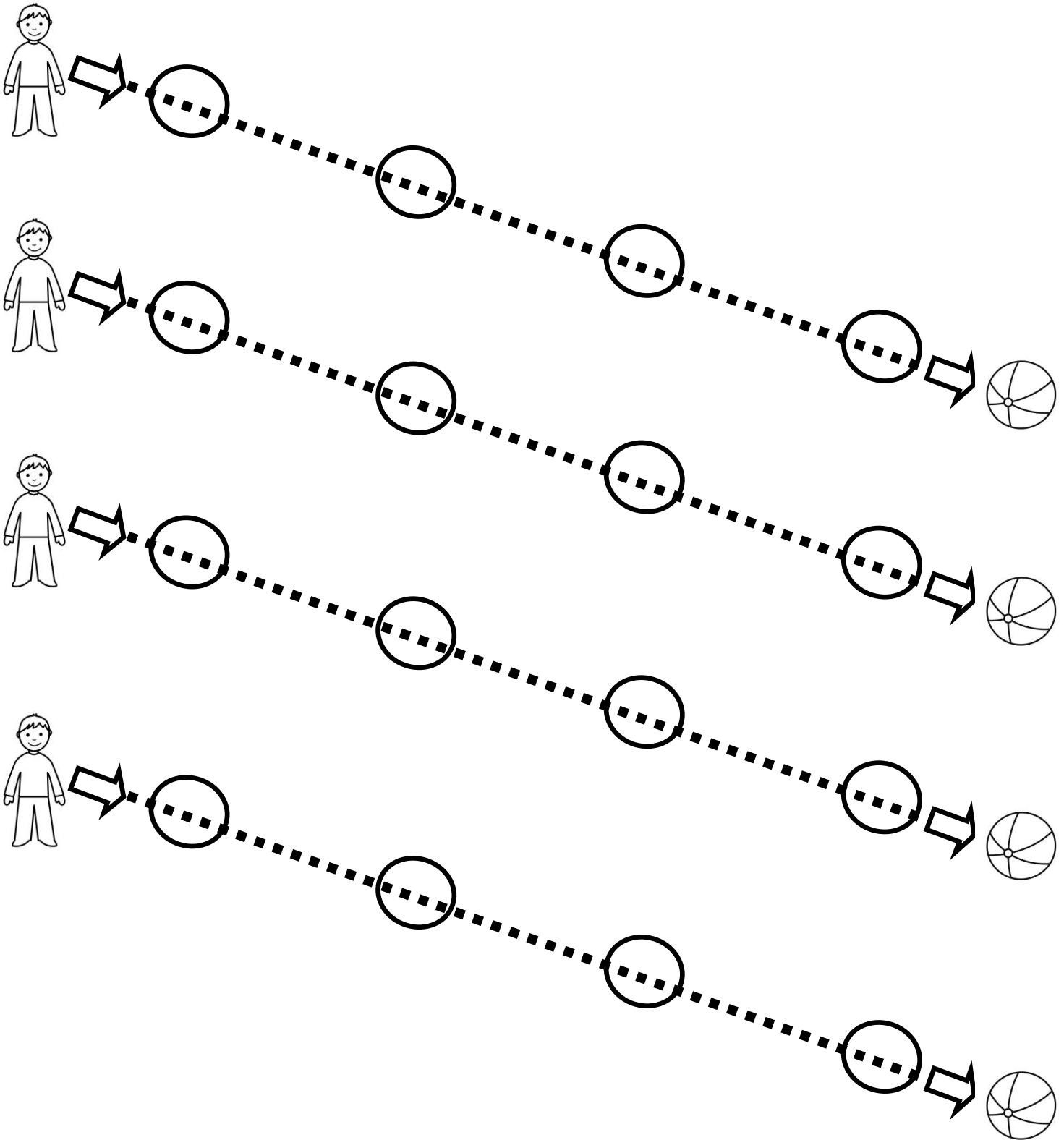

Actividades para mejorar motricidad fina

Sigue con tu lápiz los círculos para unir al niño con su pelota

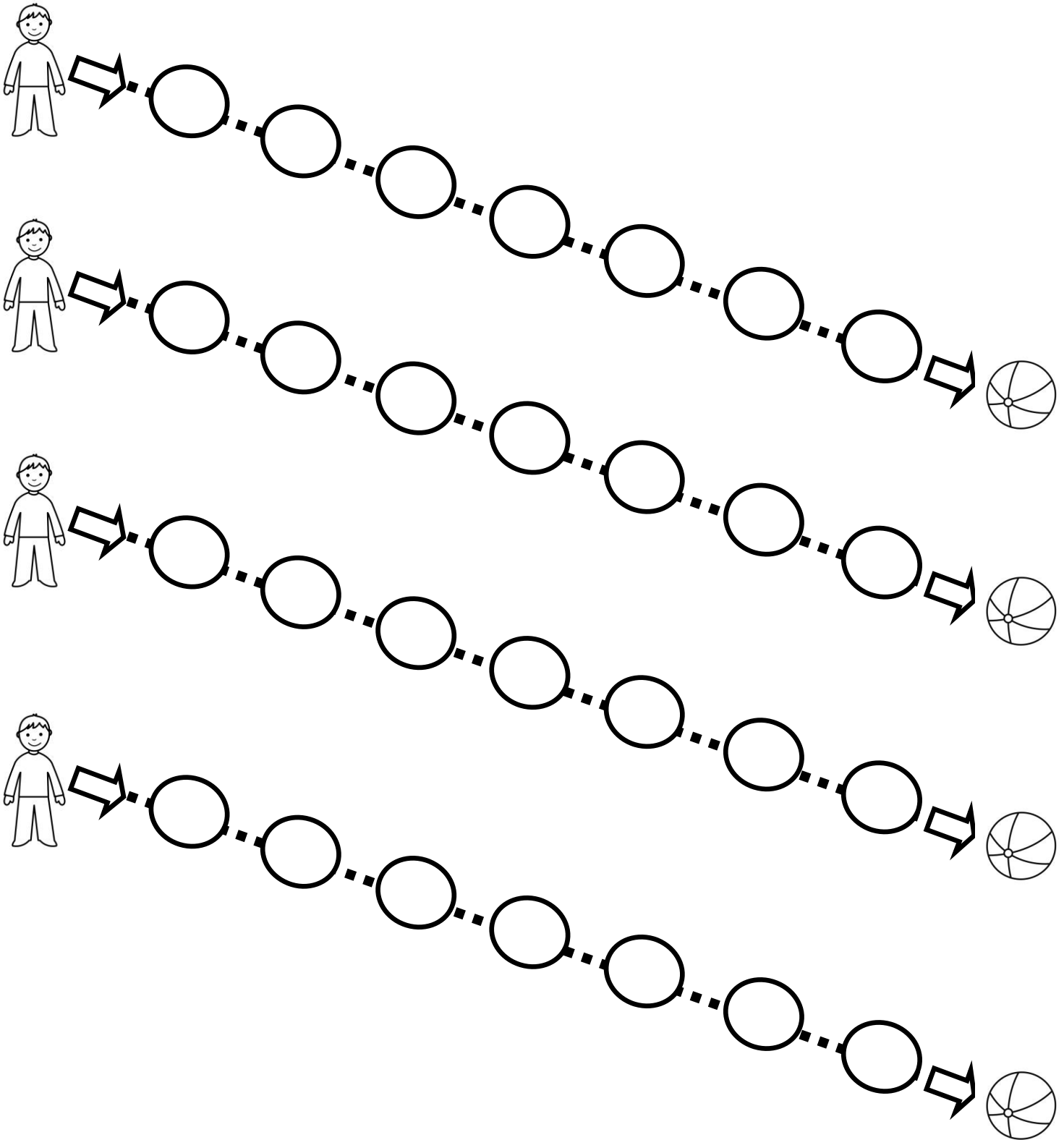

Actividades para mejorar motricidad fina

Sigue con tu lápiz los círculos para unir al niño con su pelota

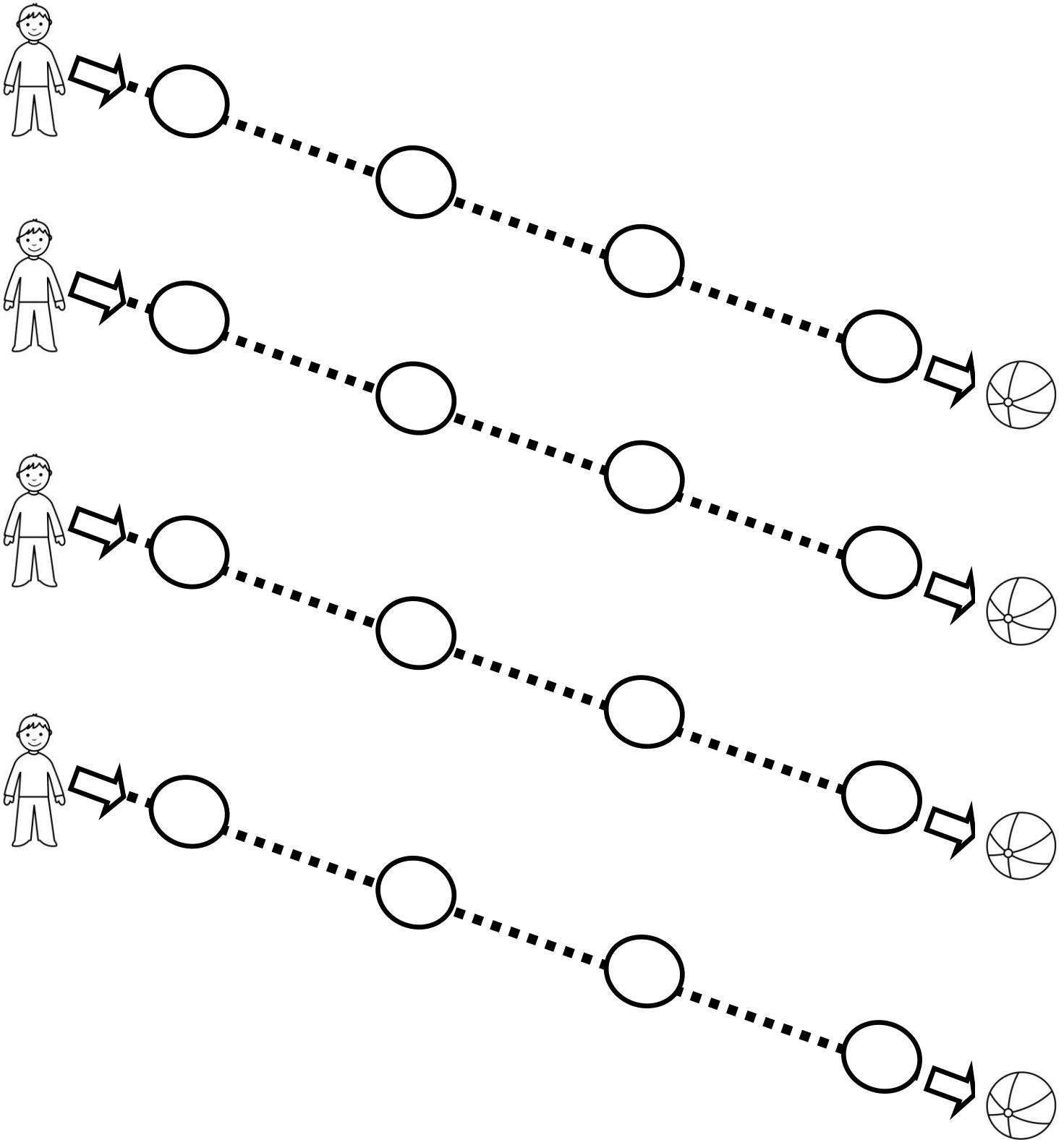

Actividades para mejorar motricidad fina

Sigue con tu lápiz los círculos para unir al niño con su pelota

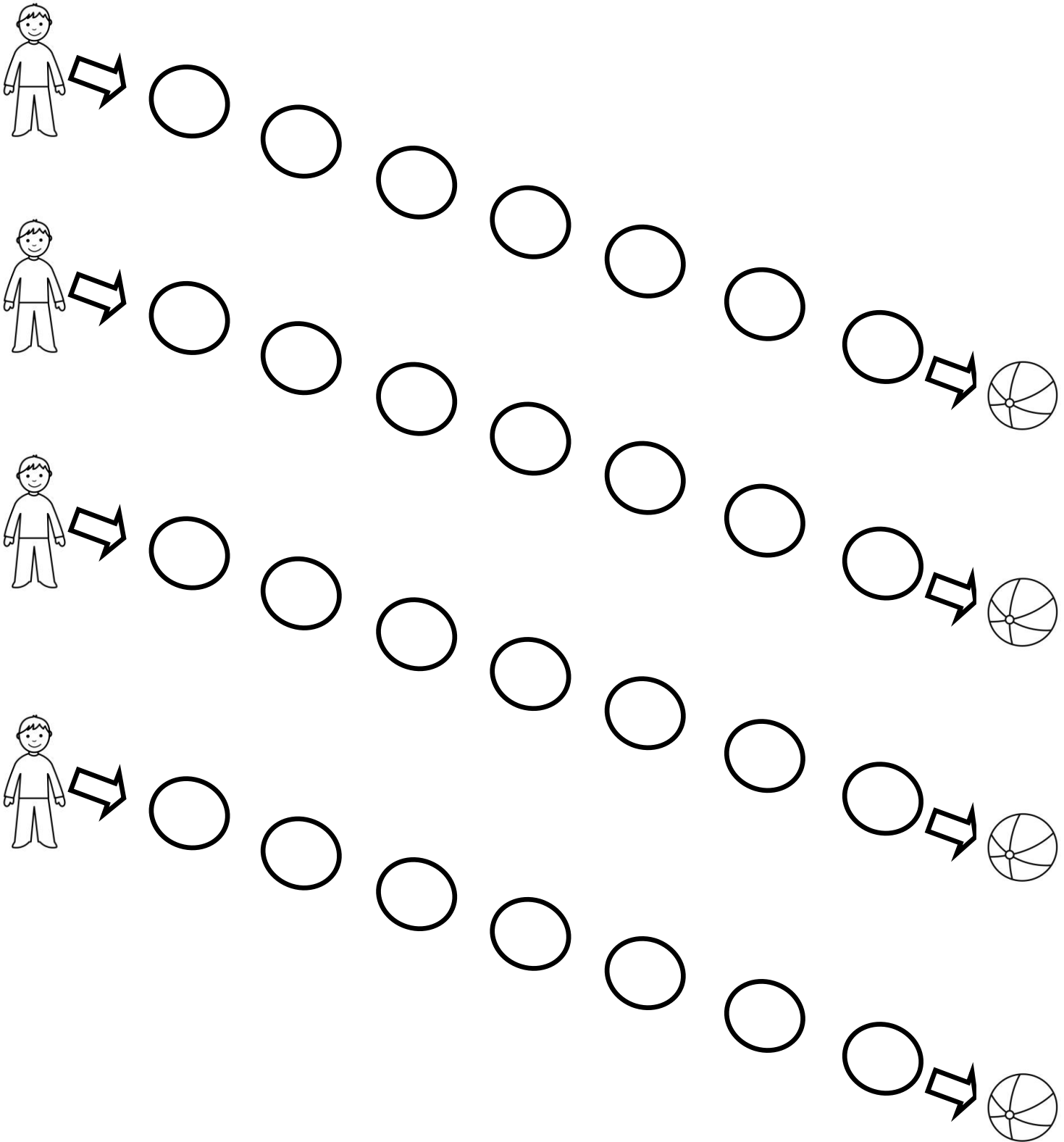

Actividades para mejorar motricidad fina

Sigue con tu lápiz los círculos para unir al niño con su pelota

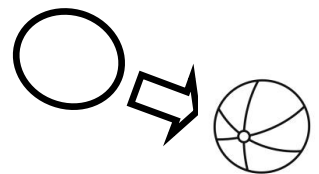
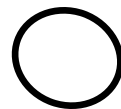
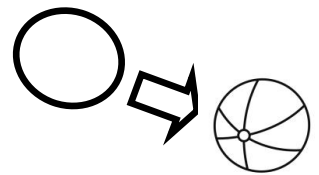
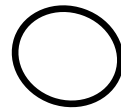
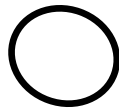
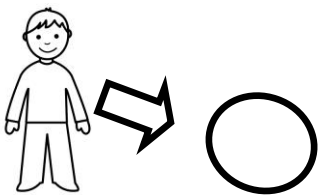
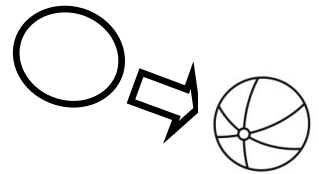
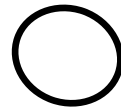
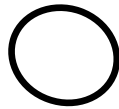
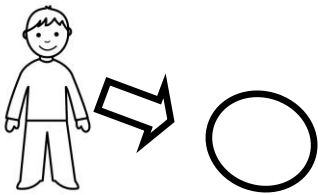
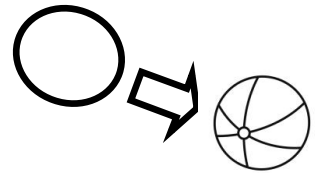
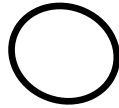
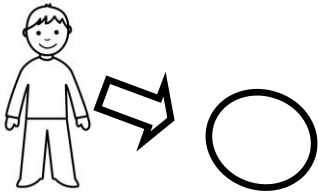
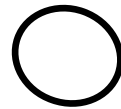
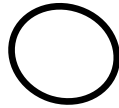
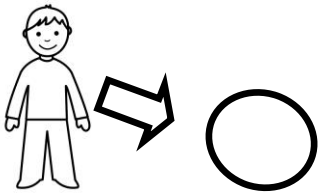

Actividades para mejorar motricidad fina

Sigue con tu lápiz las estrellitas para ir desde el sol a la tierra

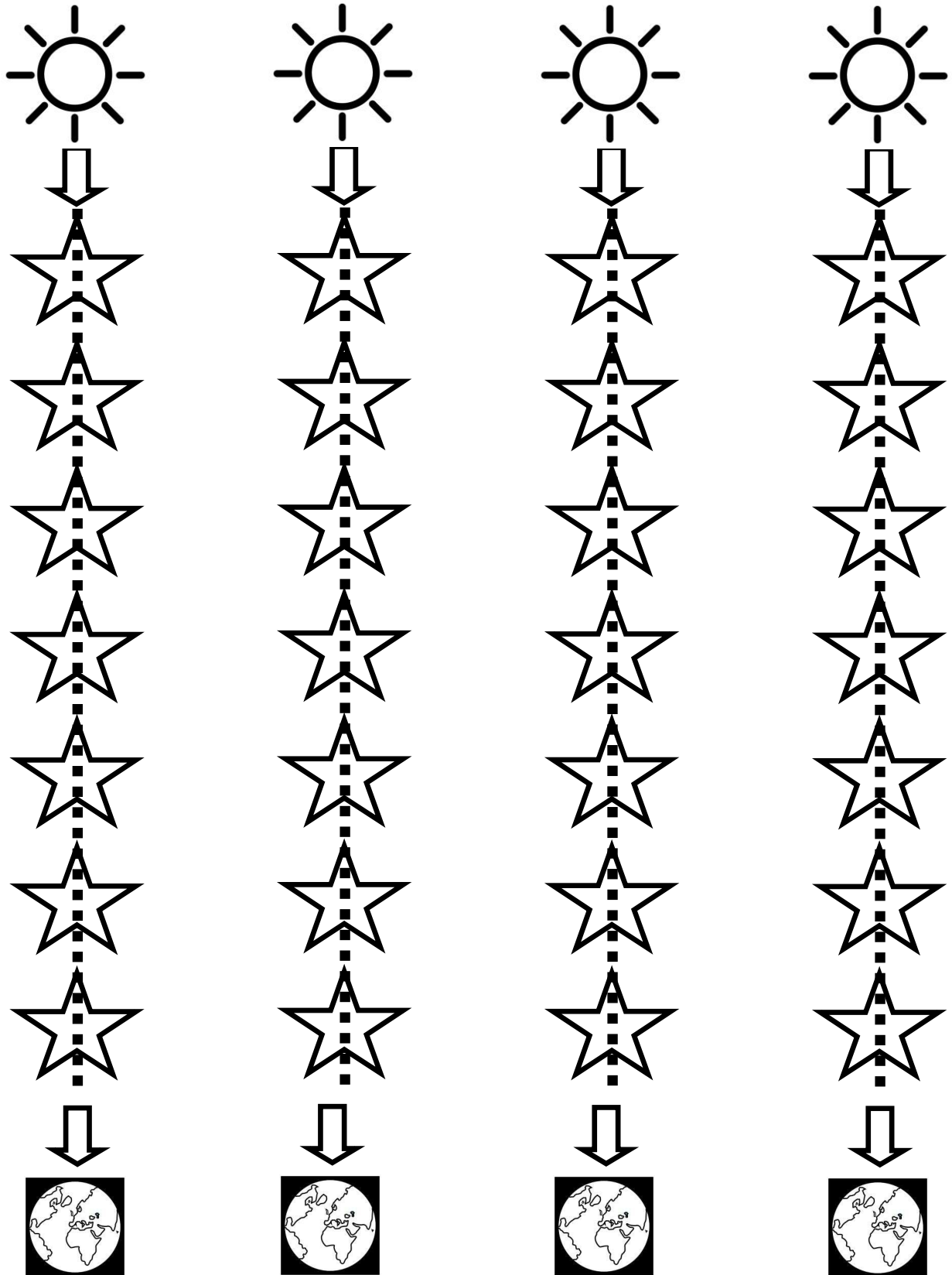

Actividades para mejorar motricidad fina

Sigue con tu lápiz las estrellitas para ir desde el sol a la tierra

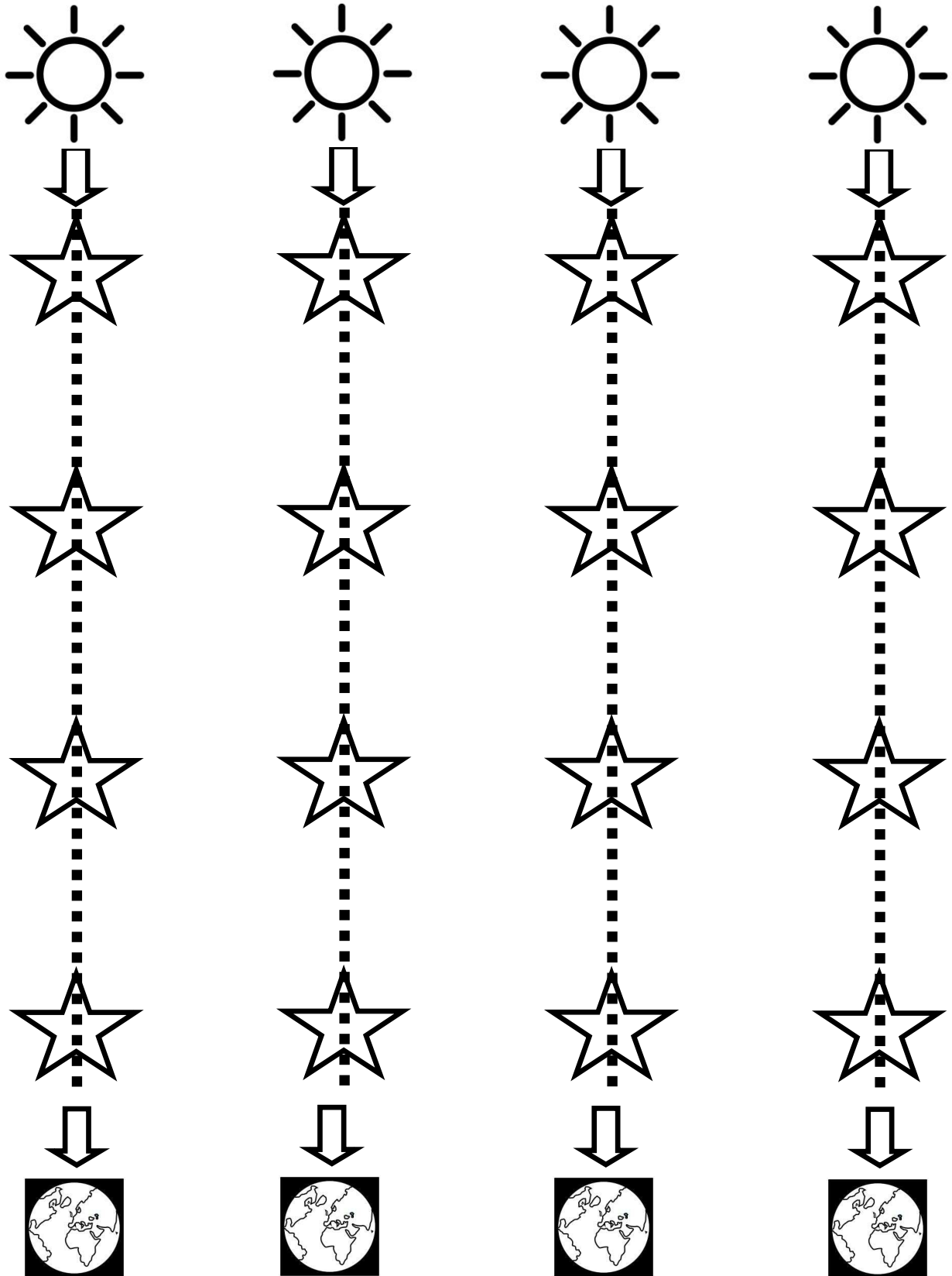

Actividades para mejorar motricidad fina

Sigue con tu lápiz las estrellitas para ir desde el sol a la tierra

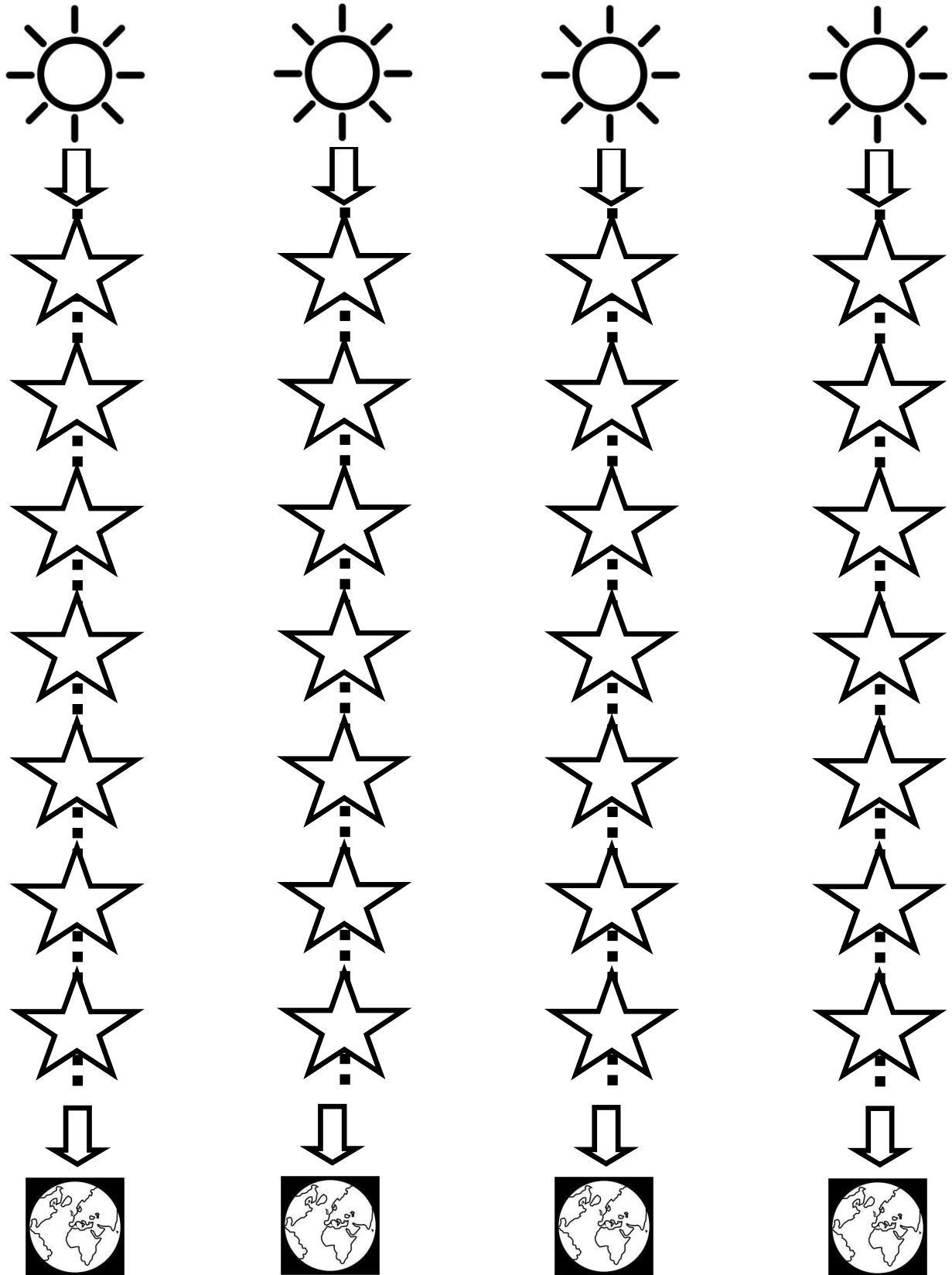

Actividades para mejorar motricidad fina

Sigue con tu lápiz las estrellitas para ir desde el sol a la tierra

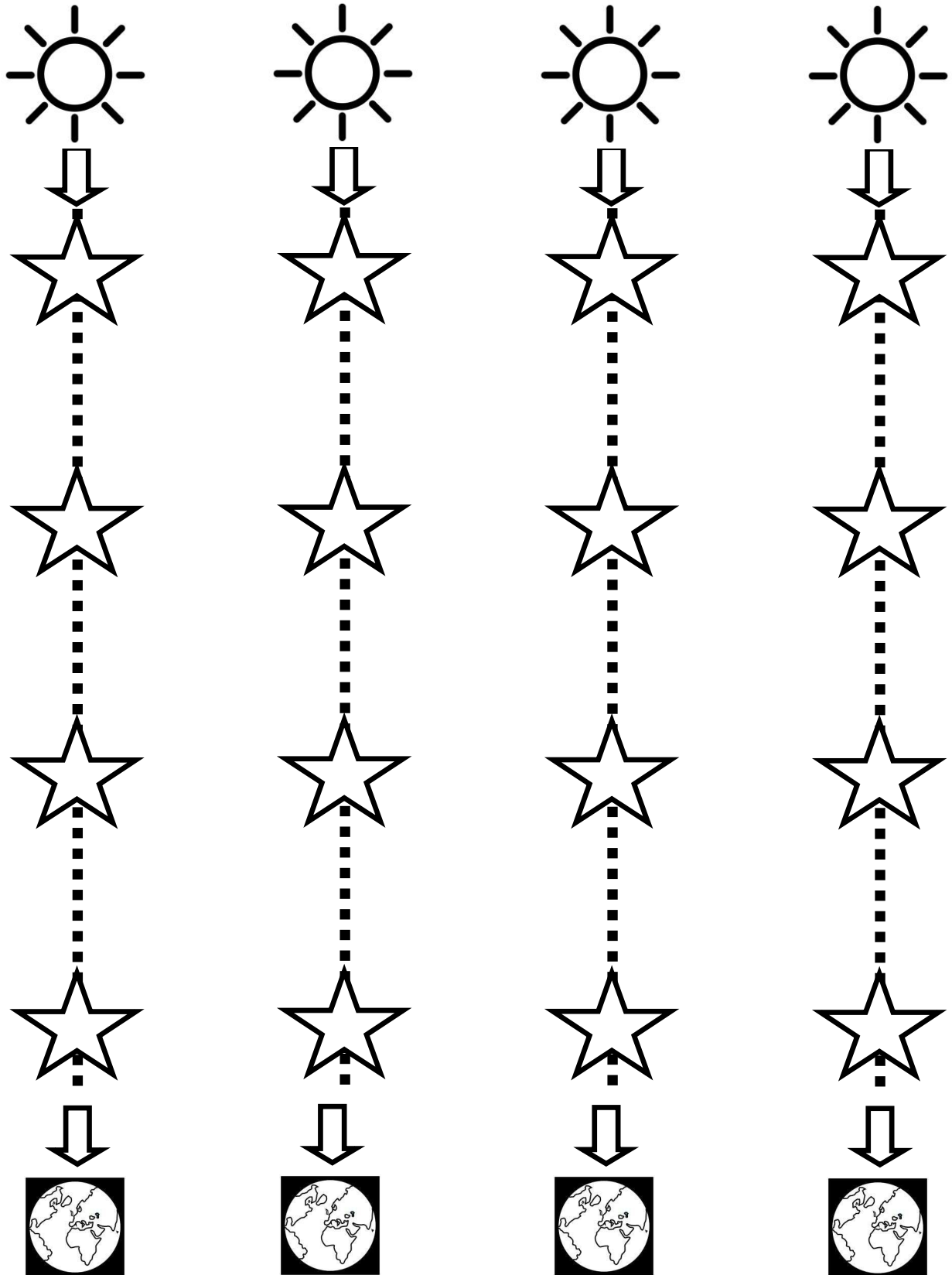

Actividades para mejorar motricidad fina

Sigue con tu lápiz las estrellitas para ir desde el sol a la tierra



Actividades para mejorar motricidad fina

Sigue con tu lápiz las estrellitas para ir desde el sol a la tierra

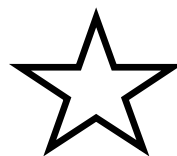
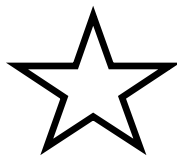
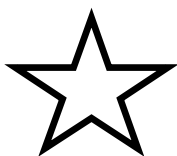
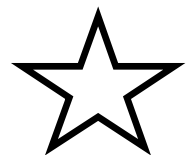
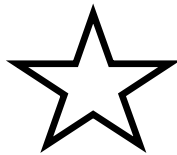
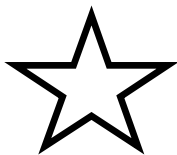
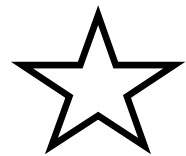
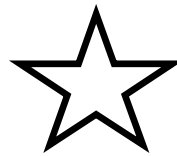
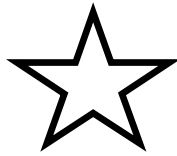
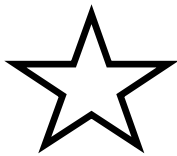
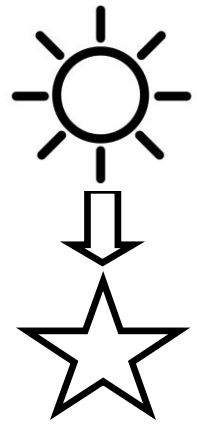
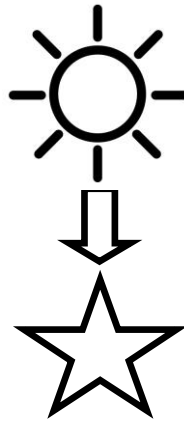
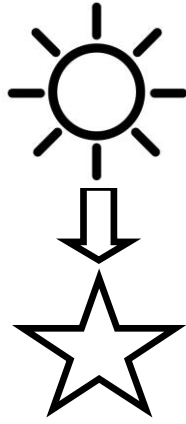
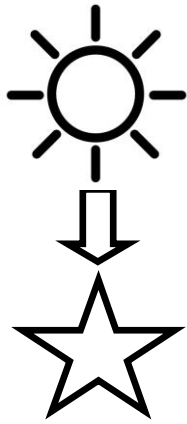

Actividades para mejorar motricidad fina

Sigue con tu lápiz los corazones para unir a la mama y a su bebe

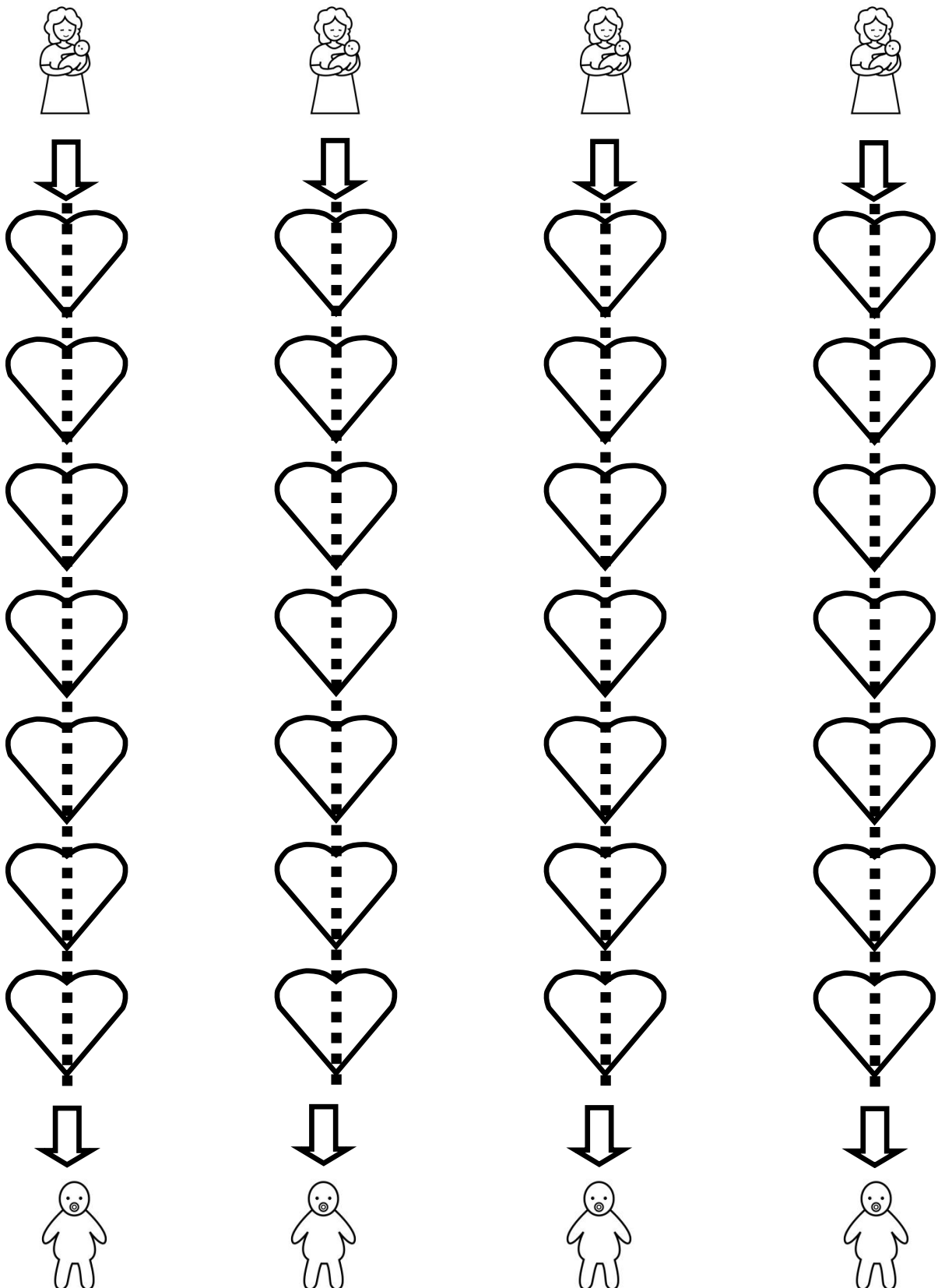

Actividades para mejorar motricidad fina

Sigue con tu lápiz los corazones para unir a la mama y a su bebe

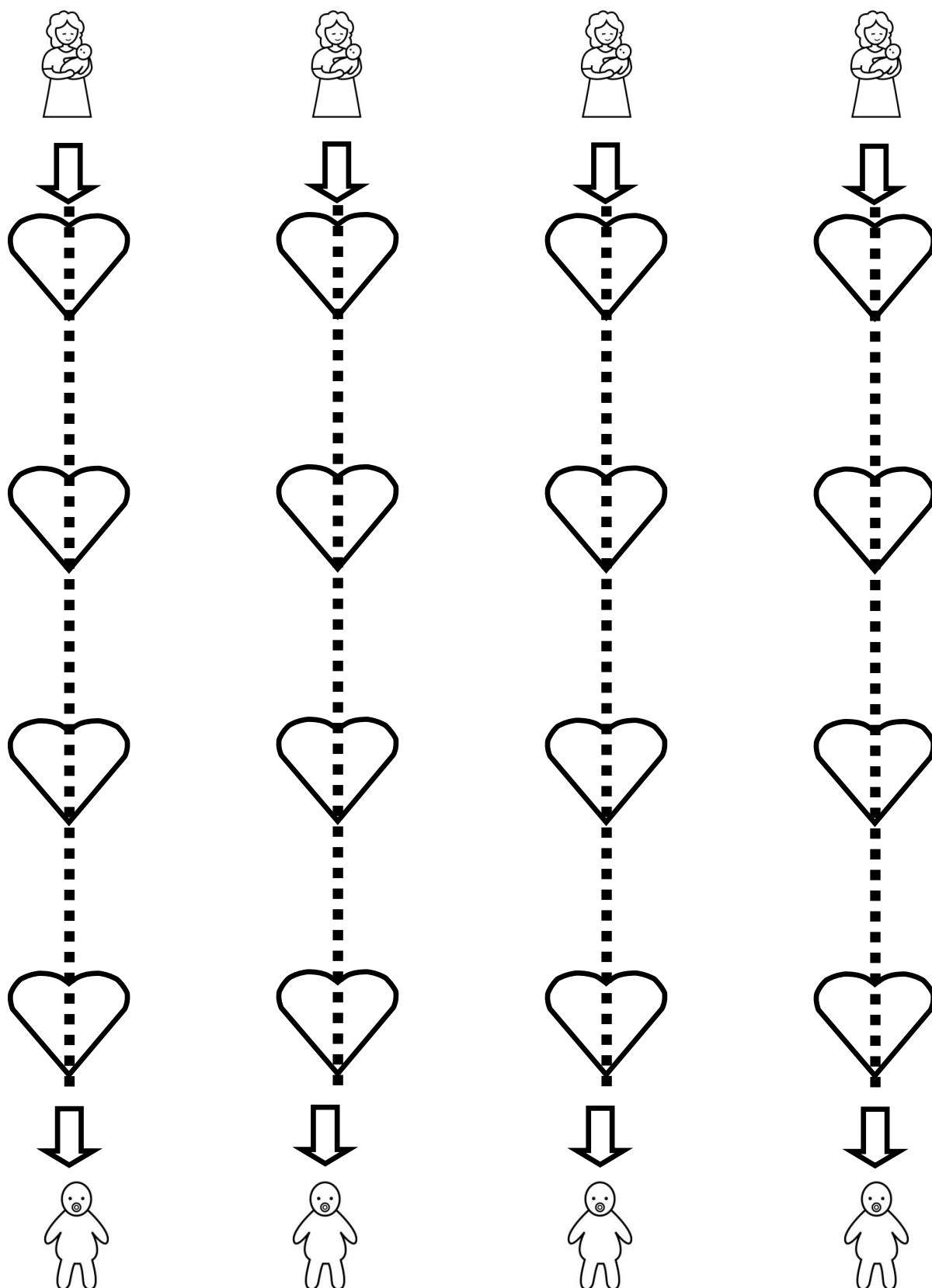

Actividades para mejorar motricidad fina

Sigue con tu lápiz los corazones para unir a la mama y a su bebe

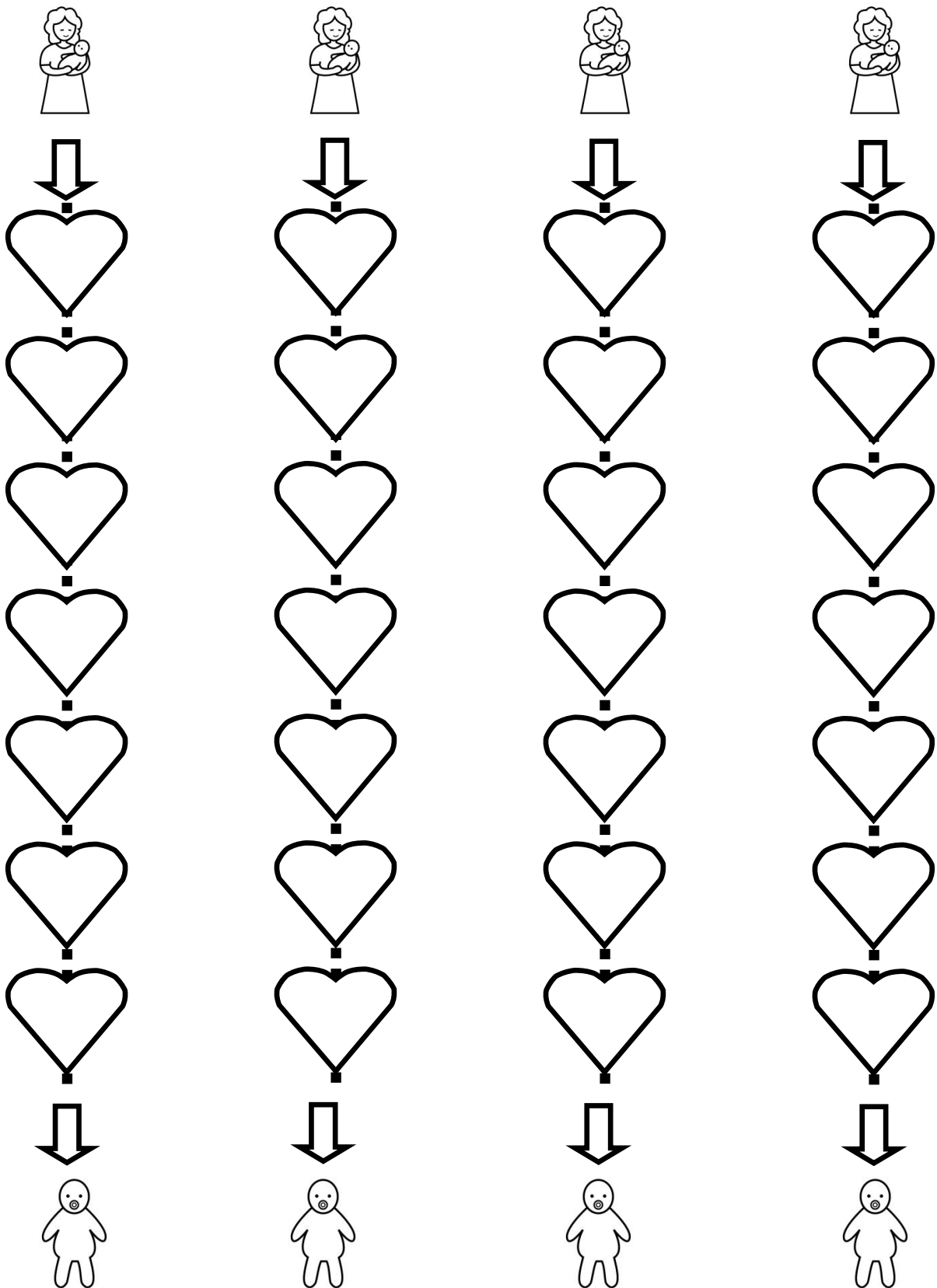

Actividades para mejorar motricidad fina

Sigue con tu lápiz los corazones para unir a la mama y a su bebe

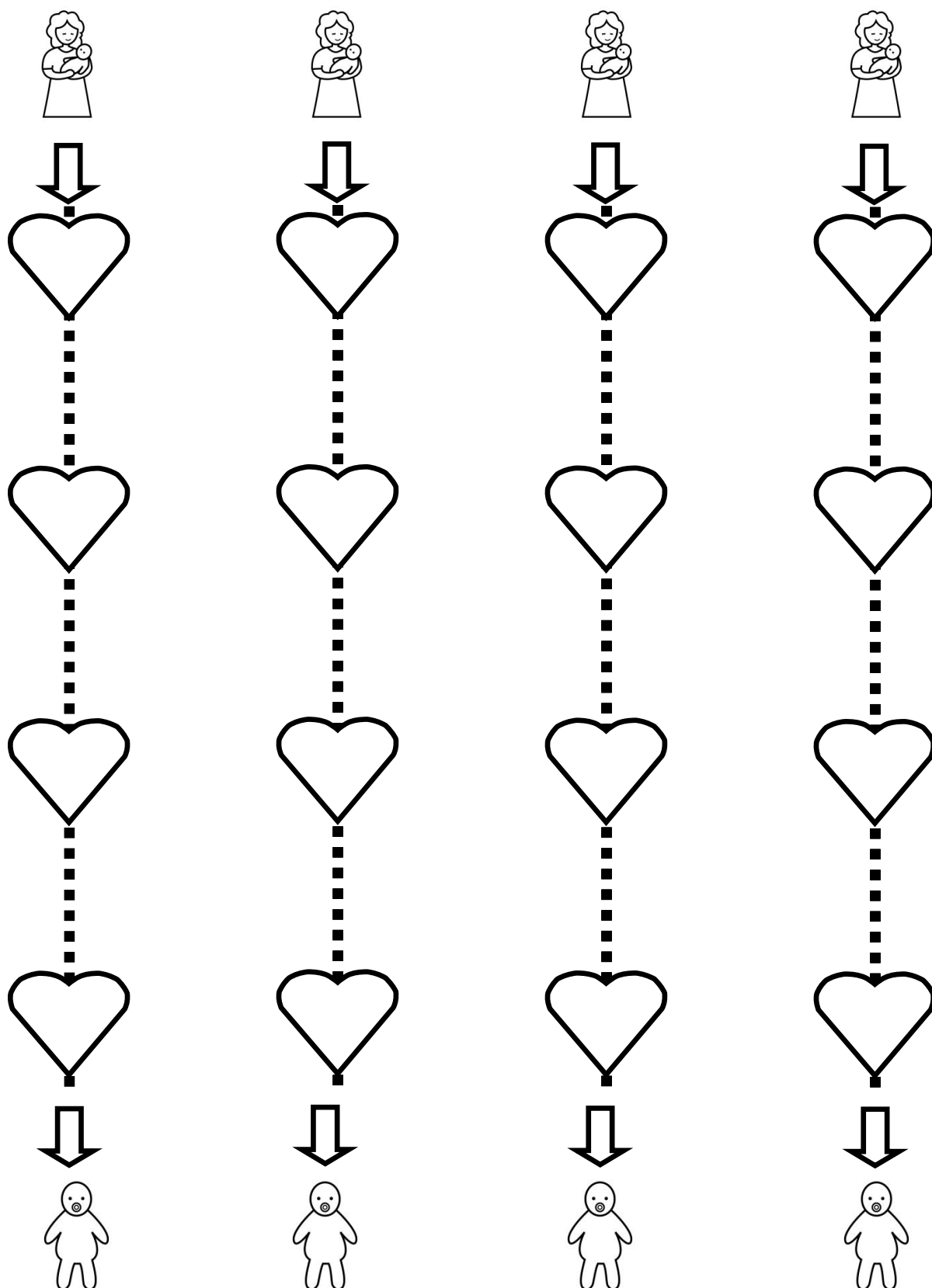

Actividades para mejorar motricidad fina

Sigue con tu lápiz los corazones para unir a la mama y a su bebe

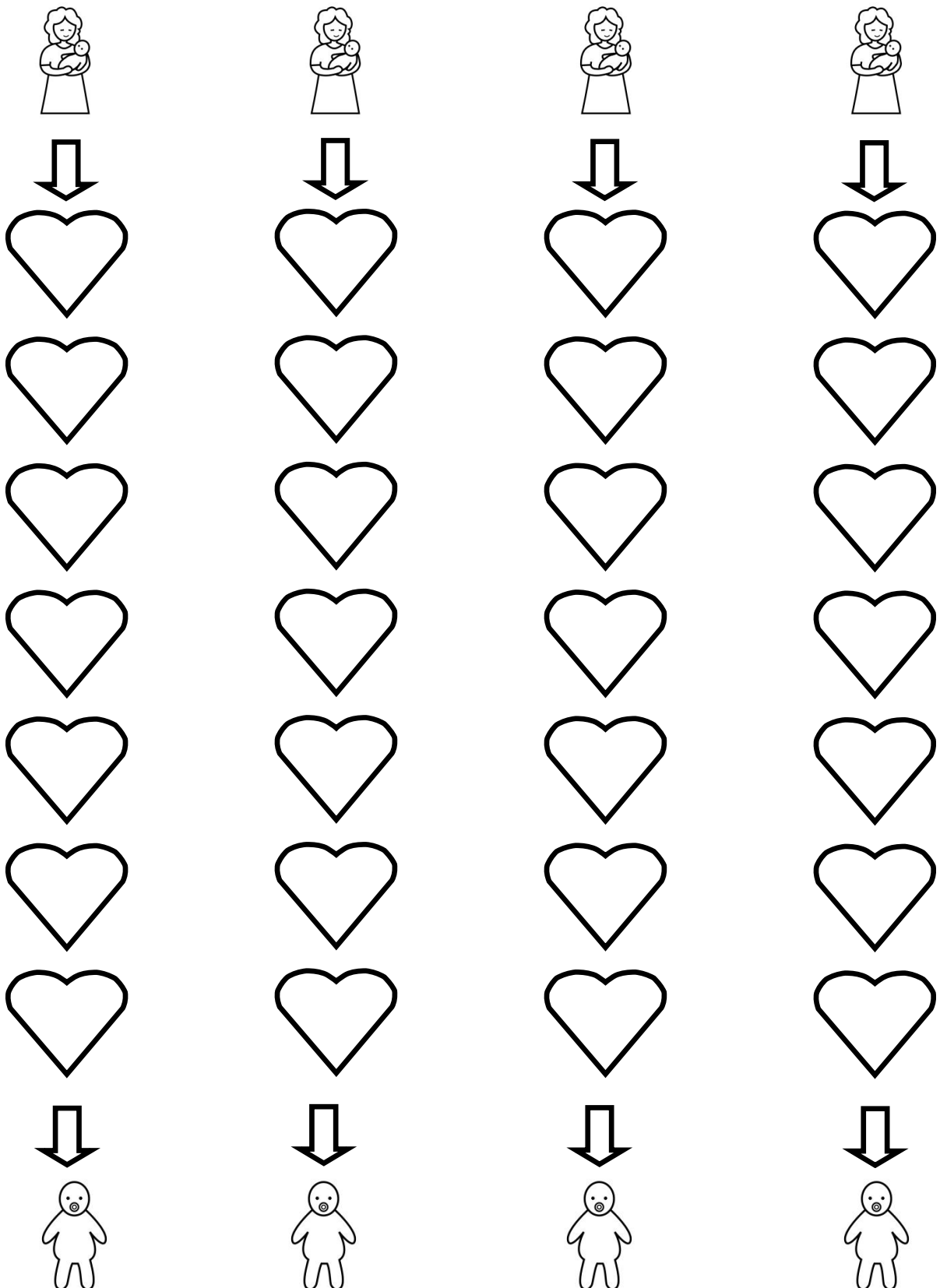

Actividades para mejorar motricidad fina

Sigue con tu lápiz los corazones para unir a la mama y a su bebe

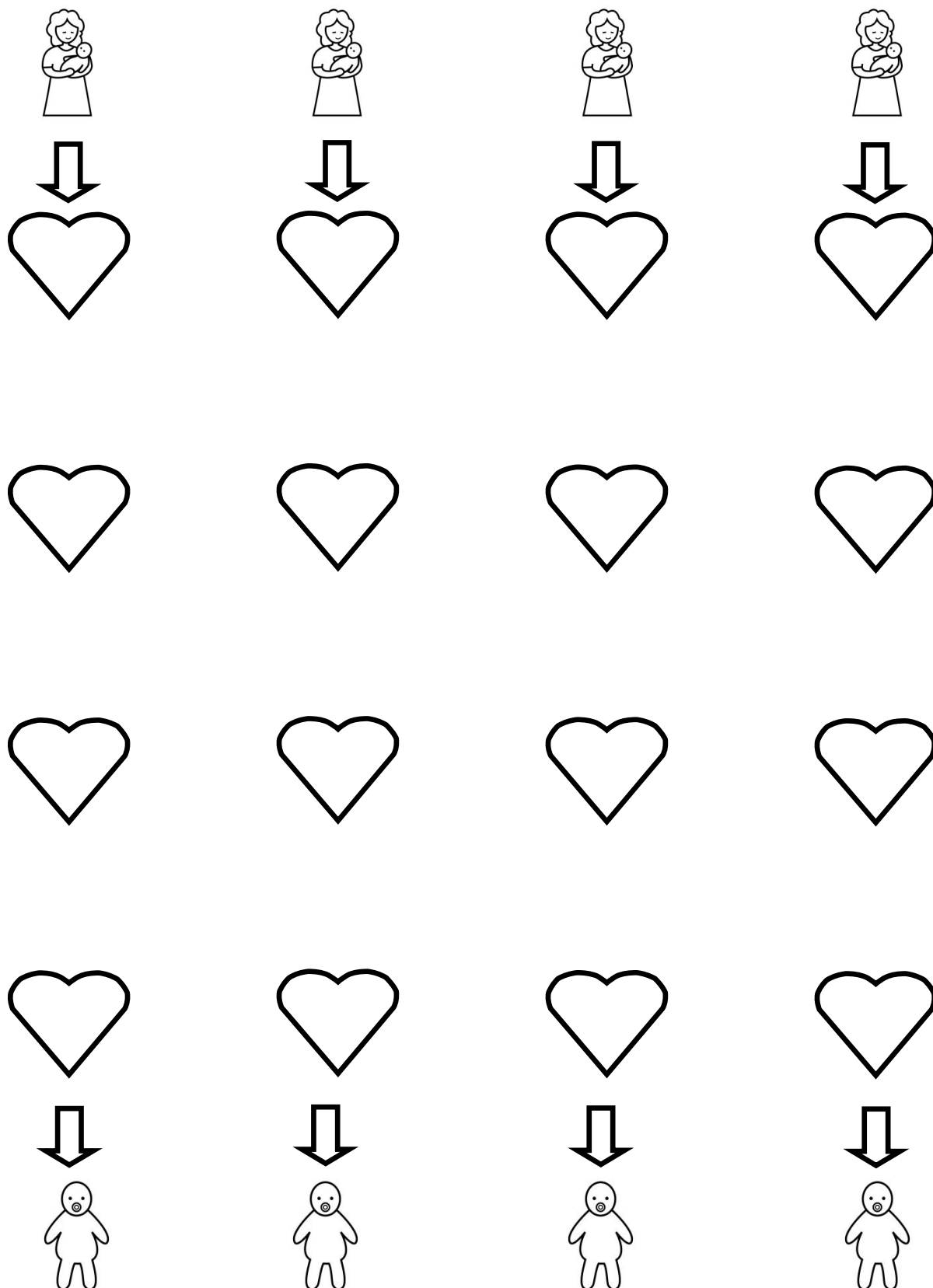

Actividades para mejorar motricidad fina

Sigue con tu lápiz las caras para unir al niño con su amiga

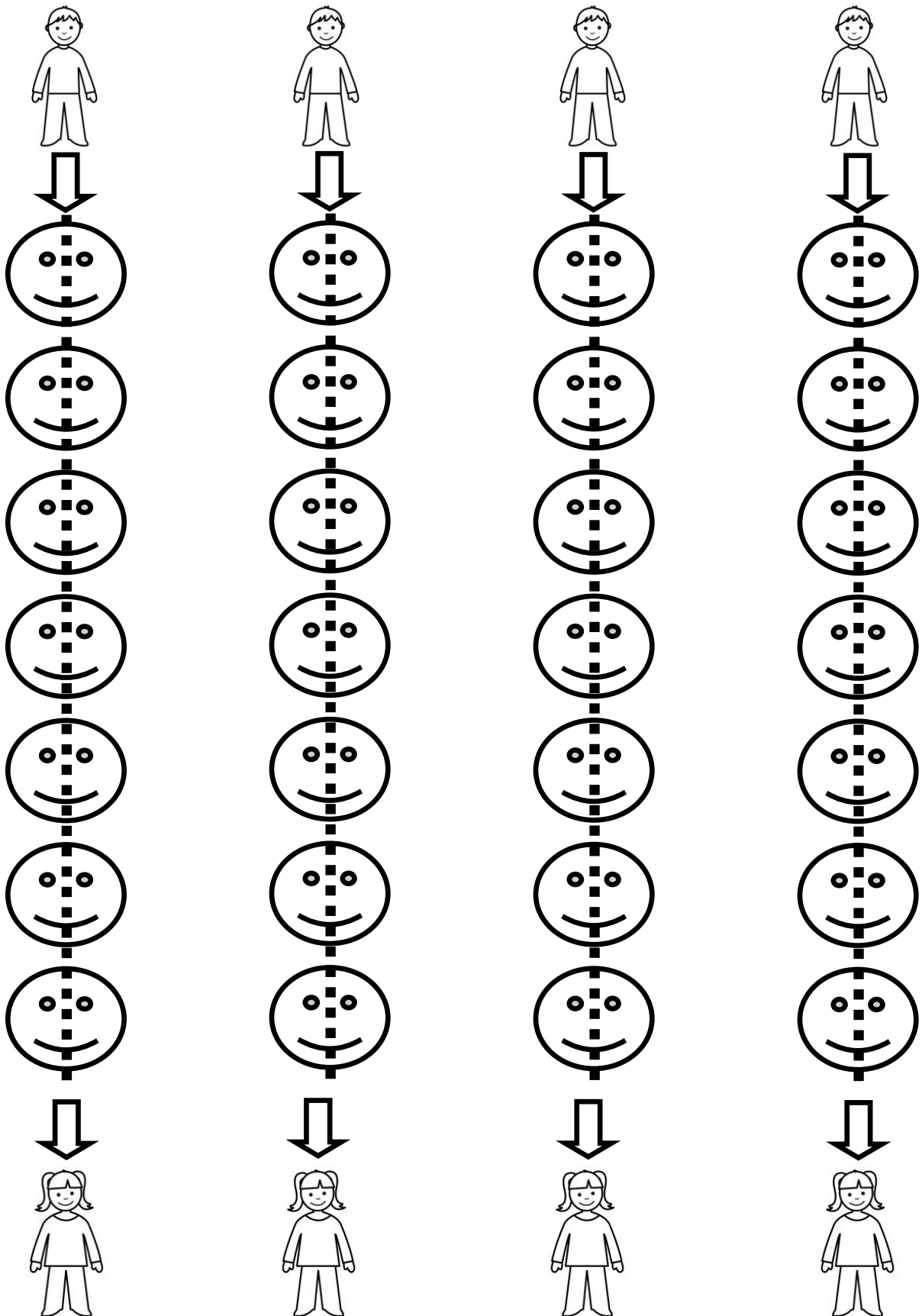

Actividades para mejorar motricidad fina

Sigue con tu lápiz caras para unir al niño con su amiga

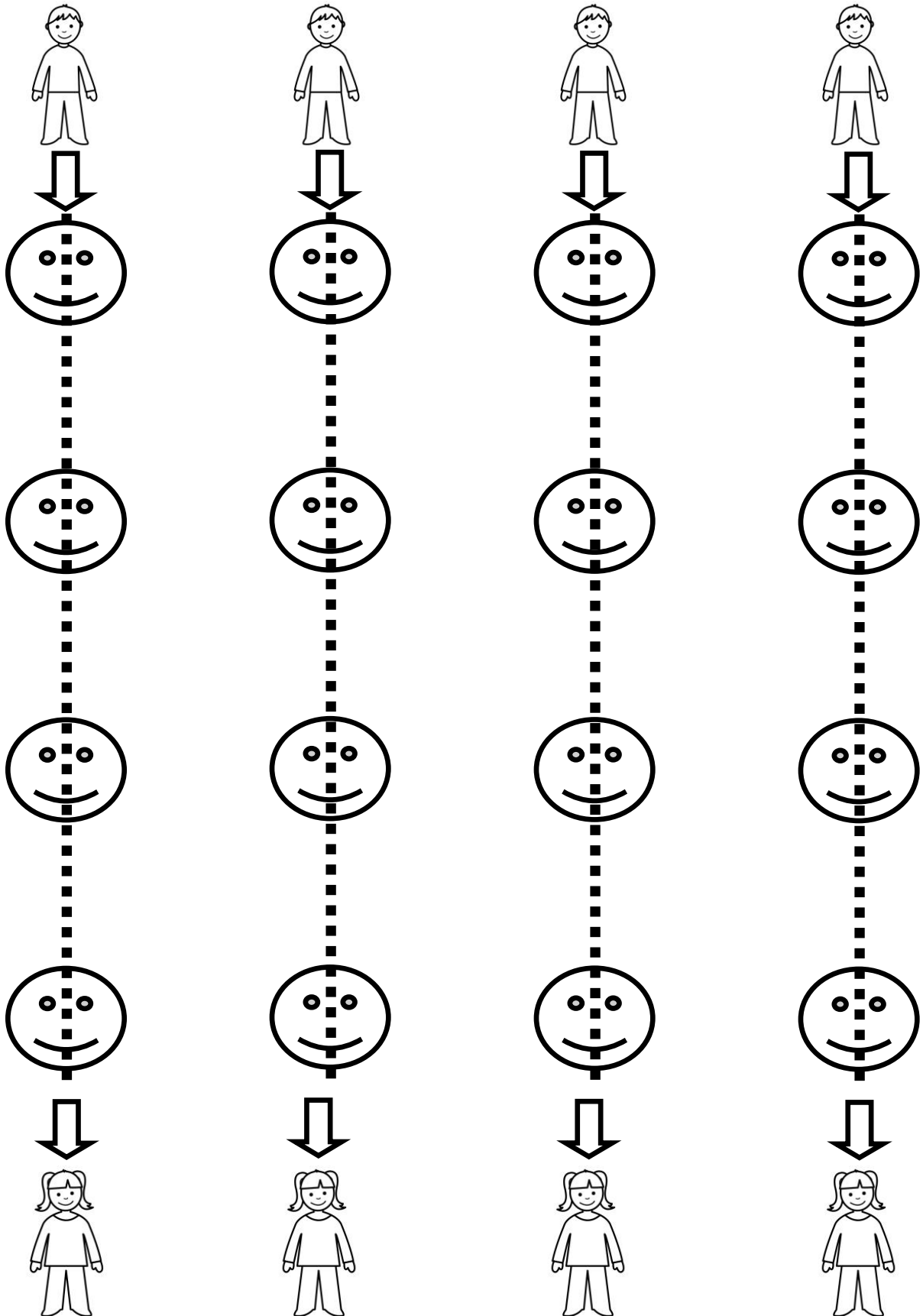

Actividades para mejorar motricidad fina

Sigue con tu lápiz caras para unir al niño con su amiga

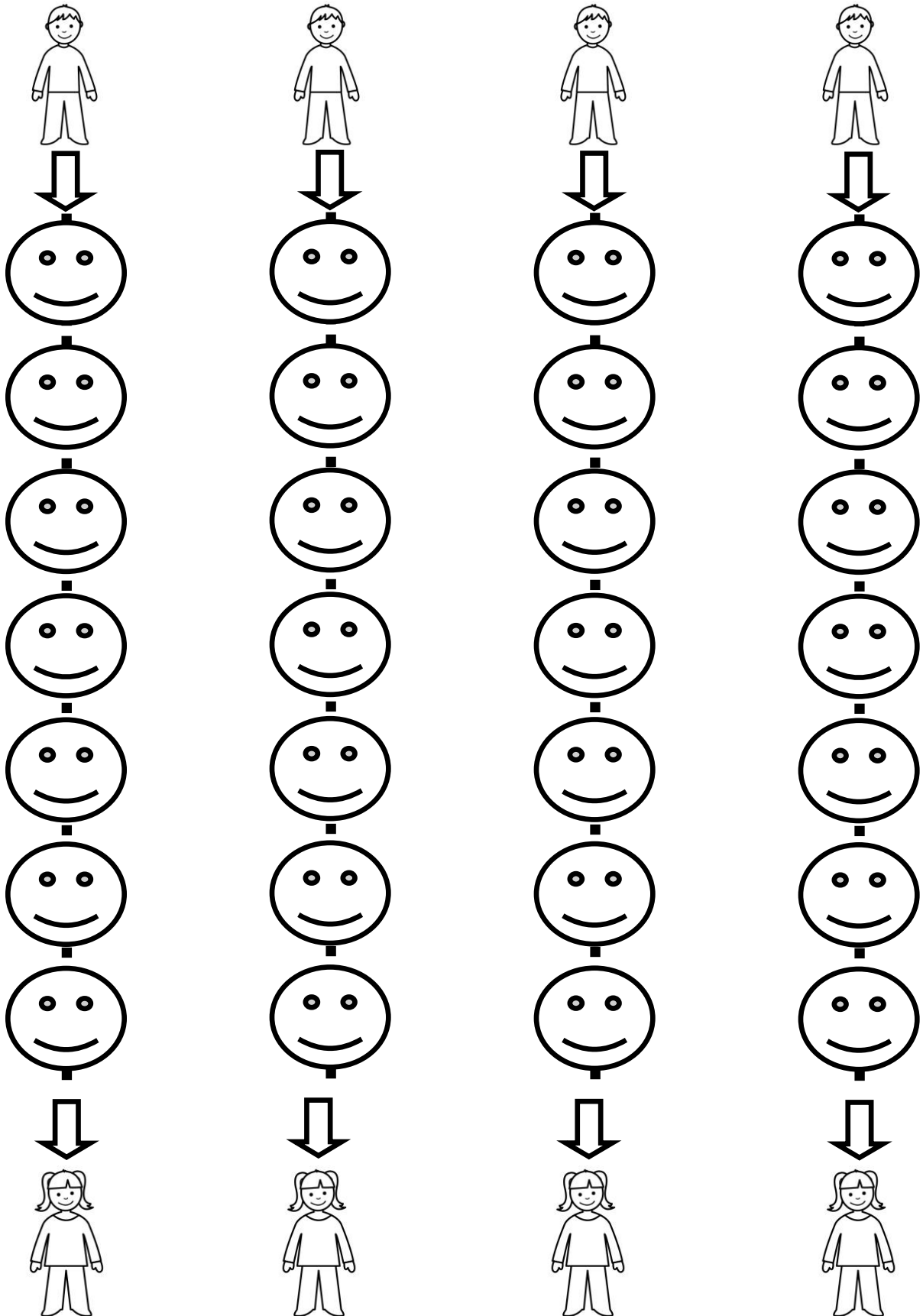

Actividades para mejorar motricidad fina

Sigue con tu lápiz caras para unir al niño con su amiga

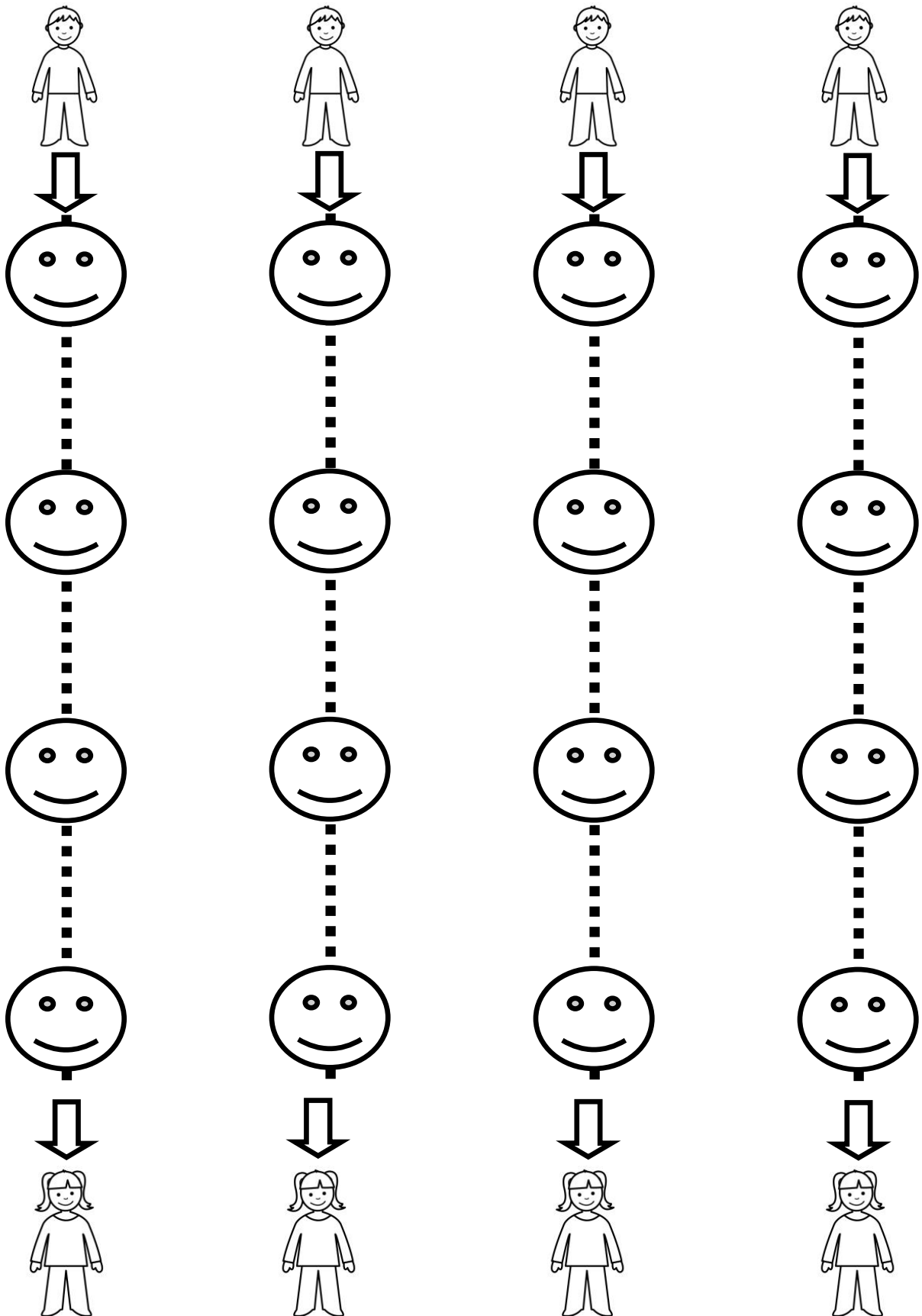

Actividades para mejorar motricidad fina

Sigue con tu lápiz caras para unir al niño con su amiga

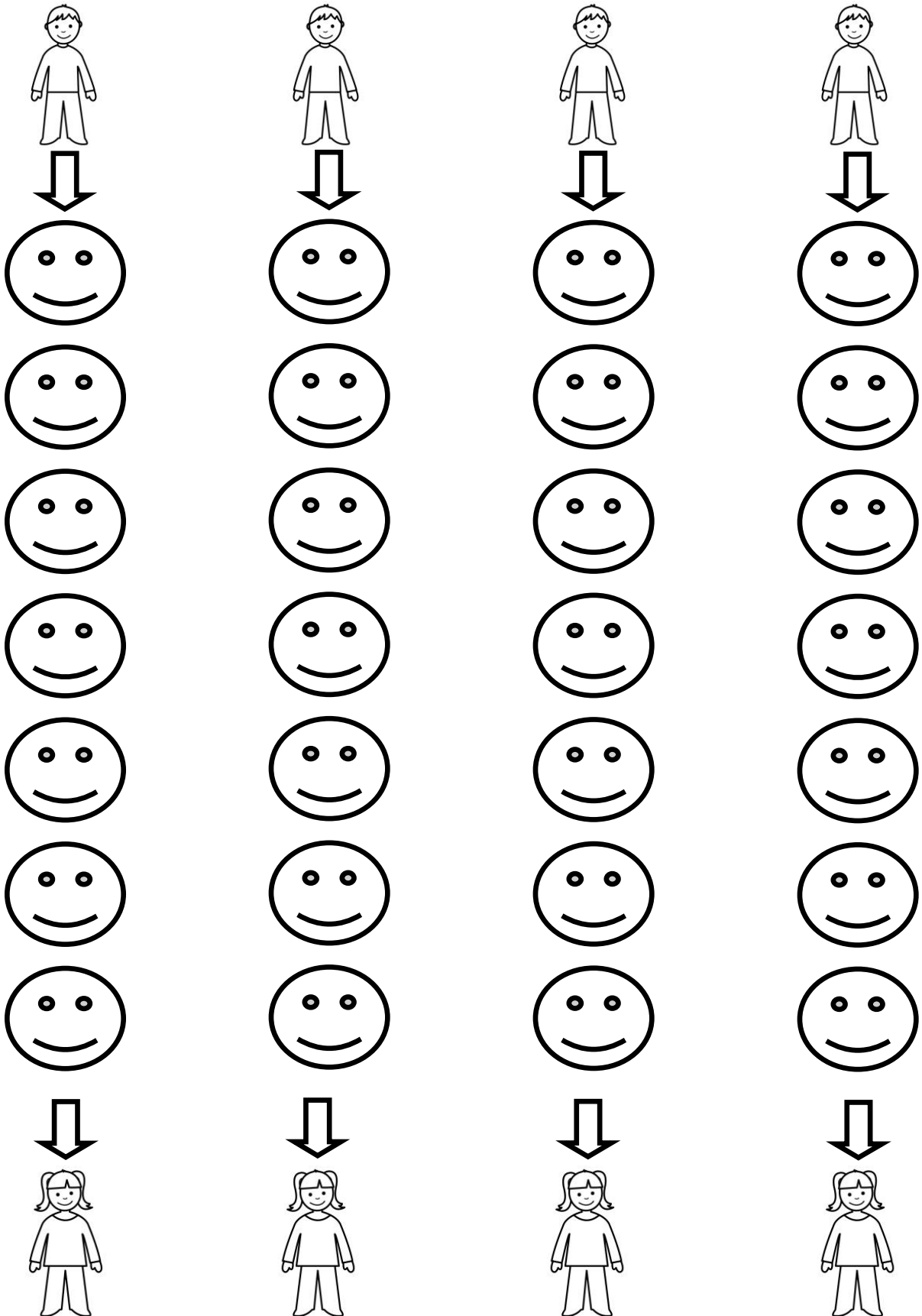

Actividades para mejorar motricidad fina

Sigue con tu lápiz caras para unir al niño con su amiga

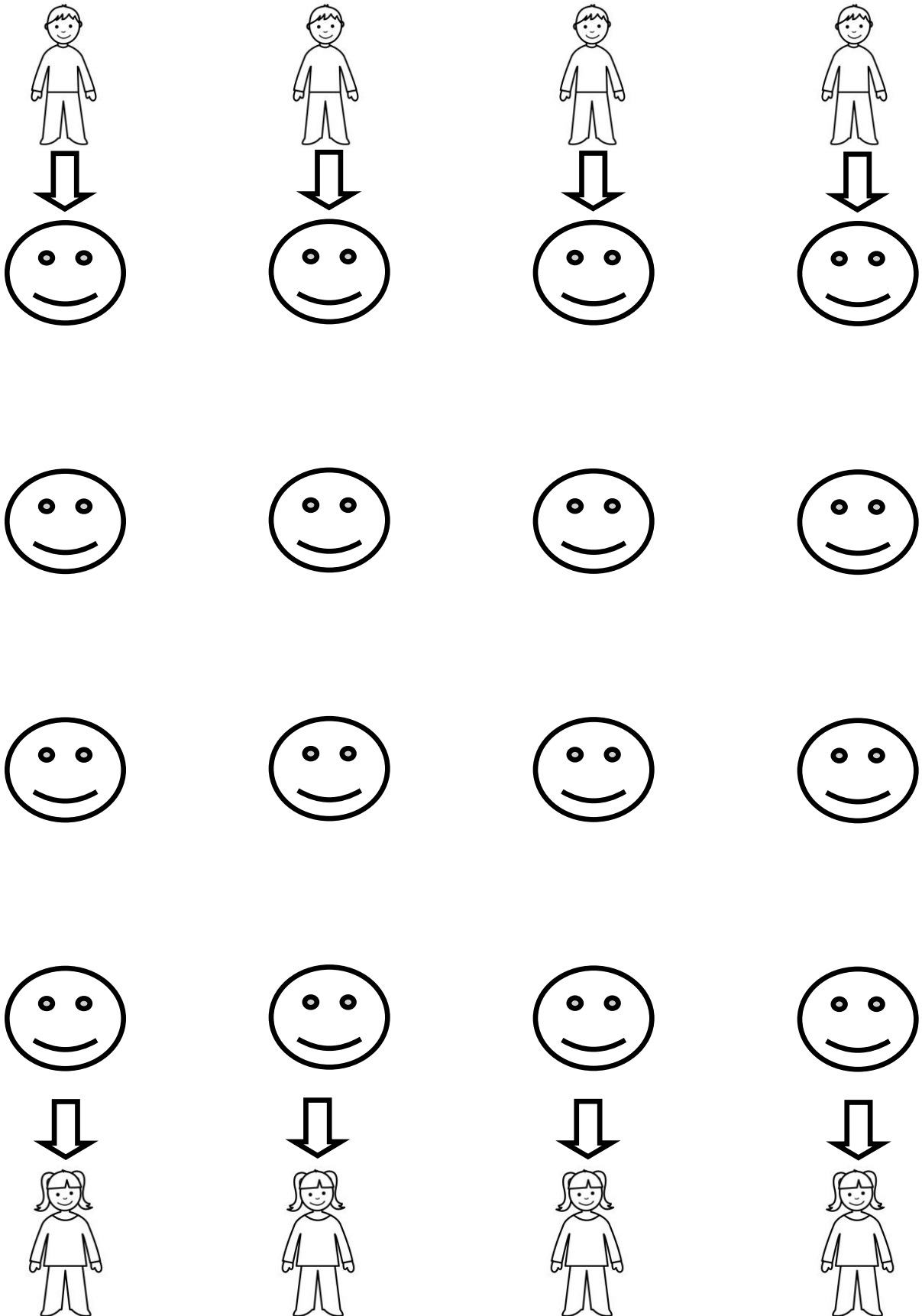

Actividades para mejorar motricidad fina

Sigue con tu lápiz los círculos para unir al niño con su balón

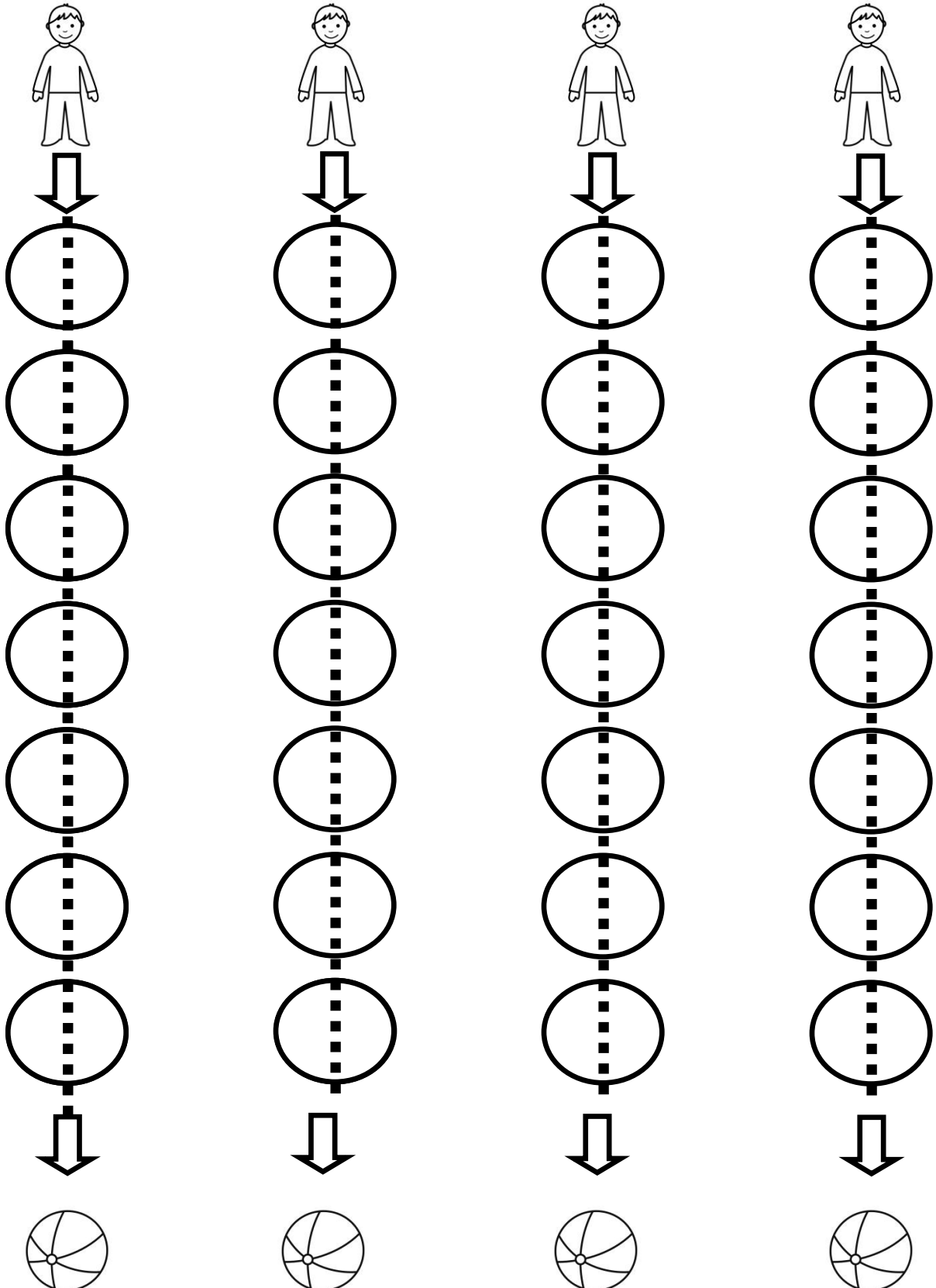

Actividades para mejorar motricidad fina

Sigue con tu lápiz los círculos para unir al niño con su balón

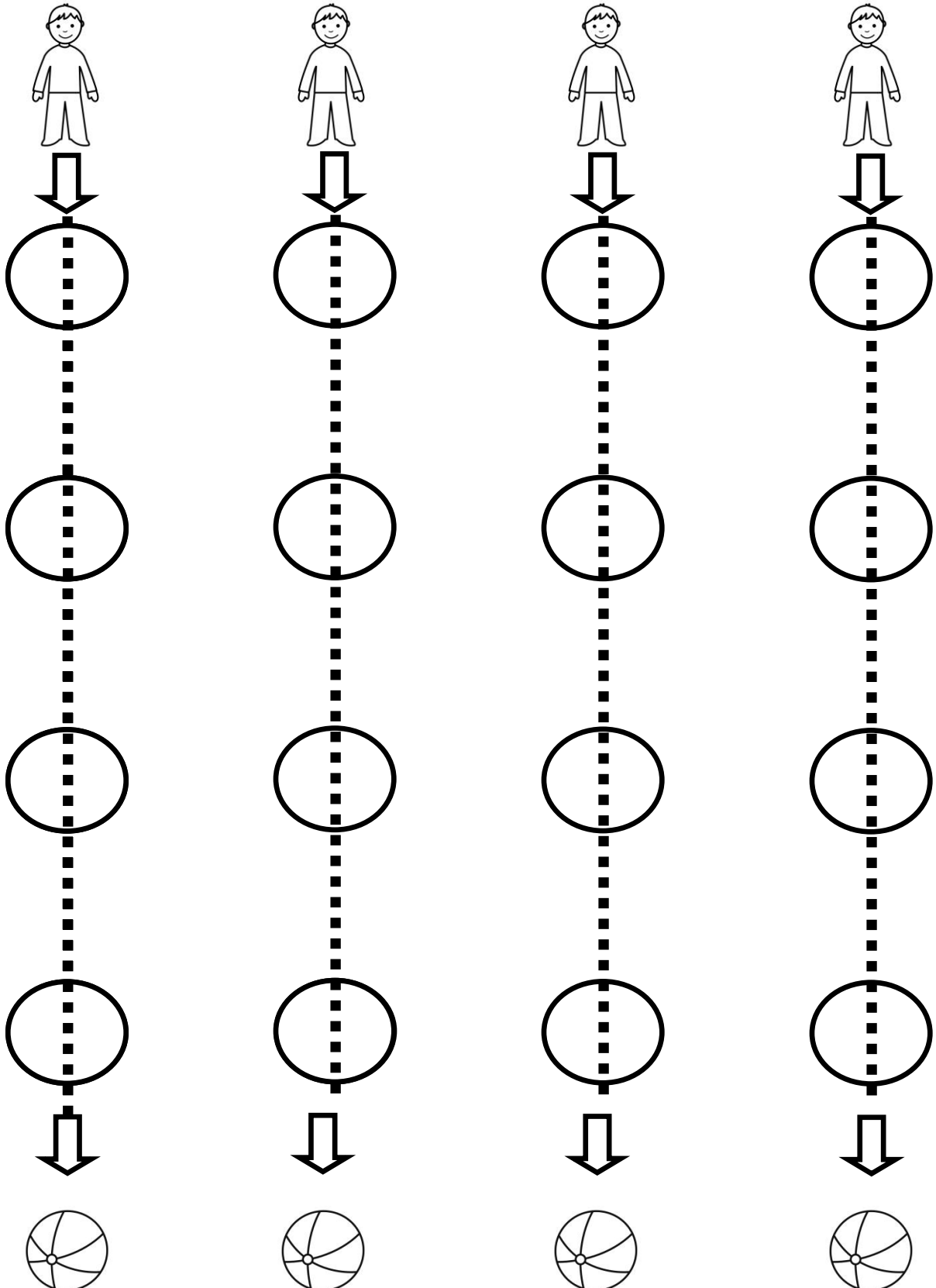

Actividades para mejorar motricidad fina

Sigue con tu lápiz los círculos para unir al niño con su balón

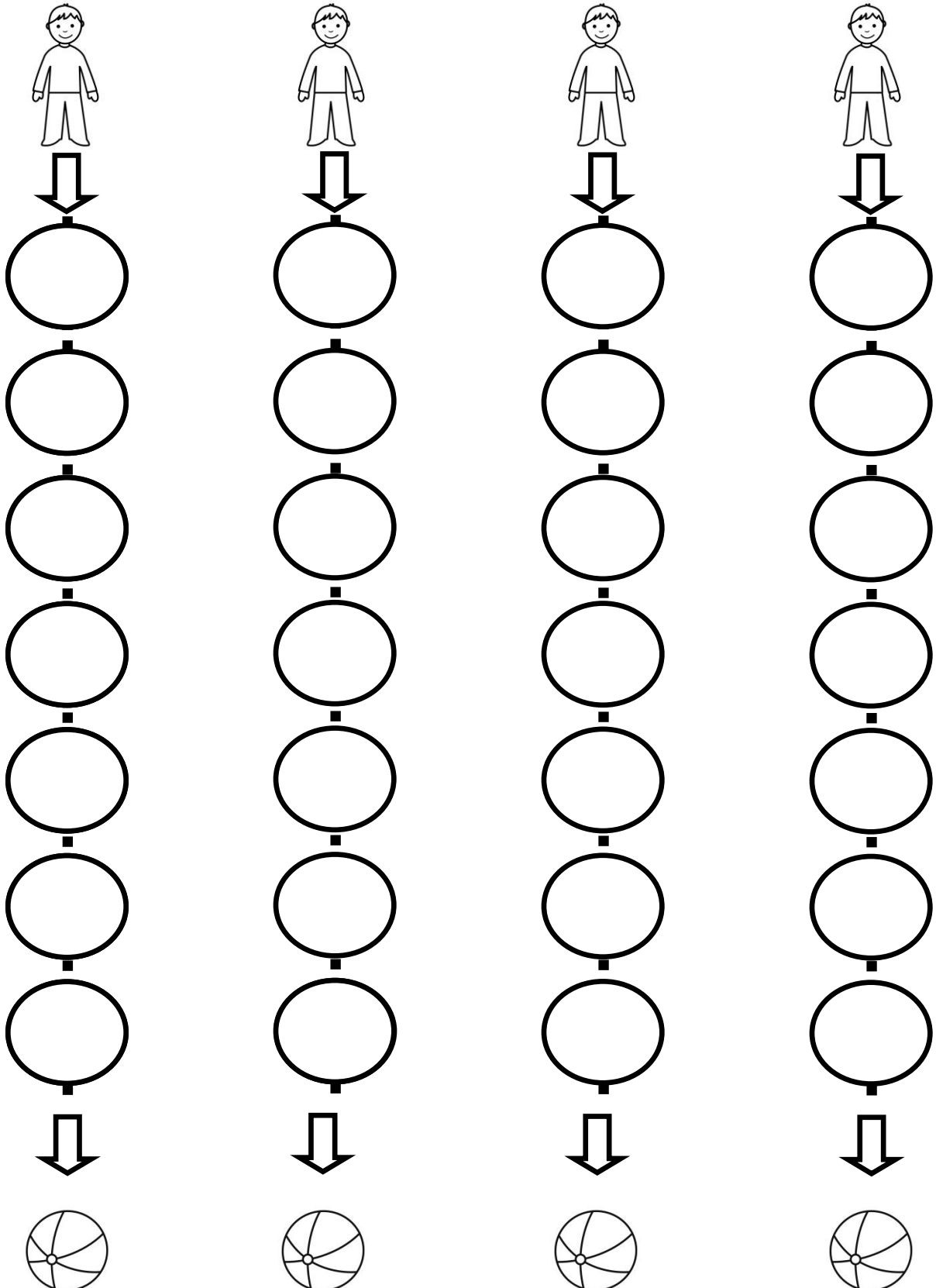

Actividades para mejorar motricidad fina

Sigue con tu lápiz los círculos para unir al niño con su balón

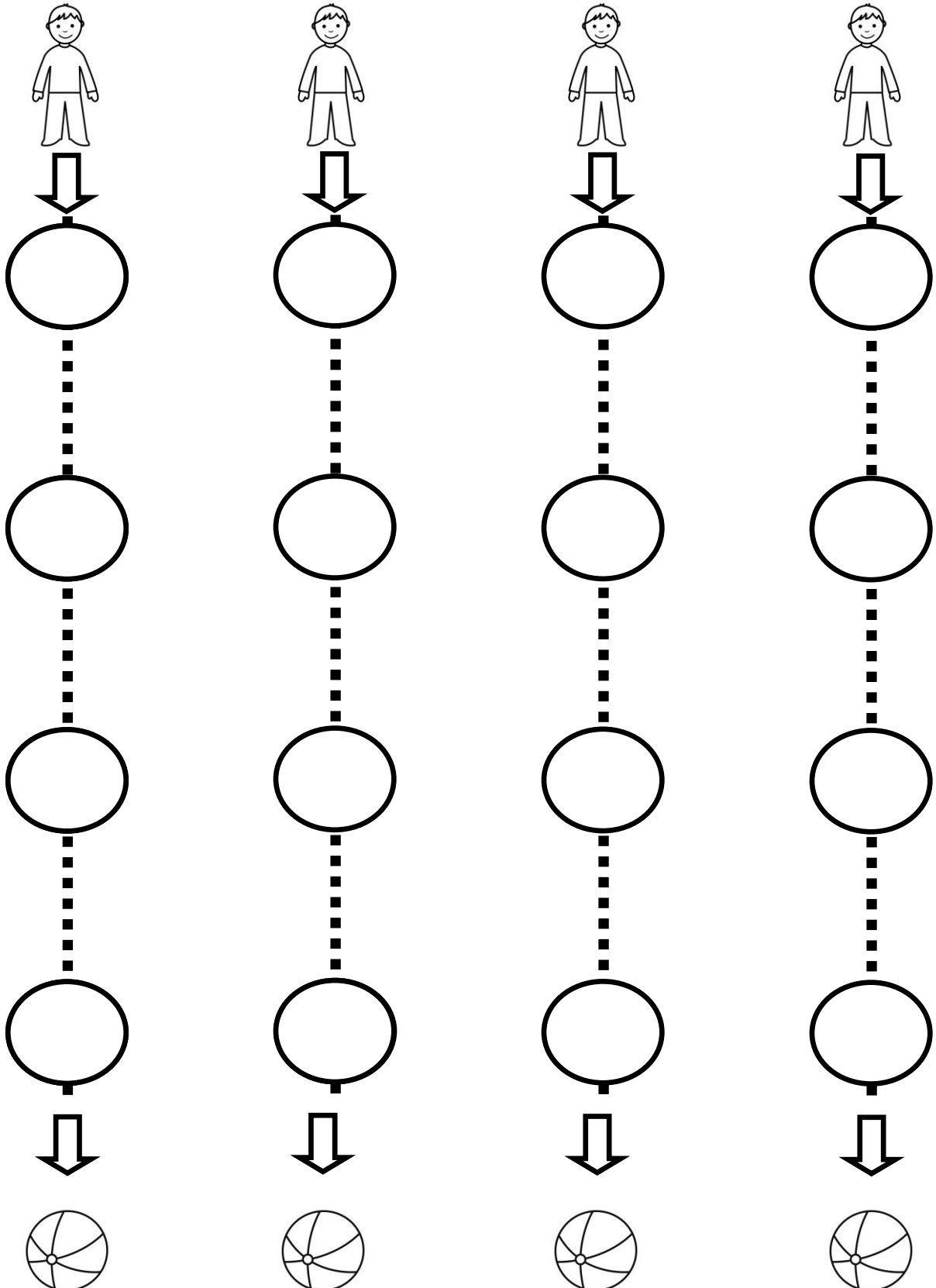

Actividades para mejorar motricidad fina

Sigue con tu lápiz los círculos para unir al niño con su balón

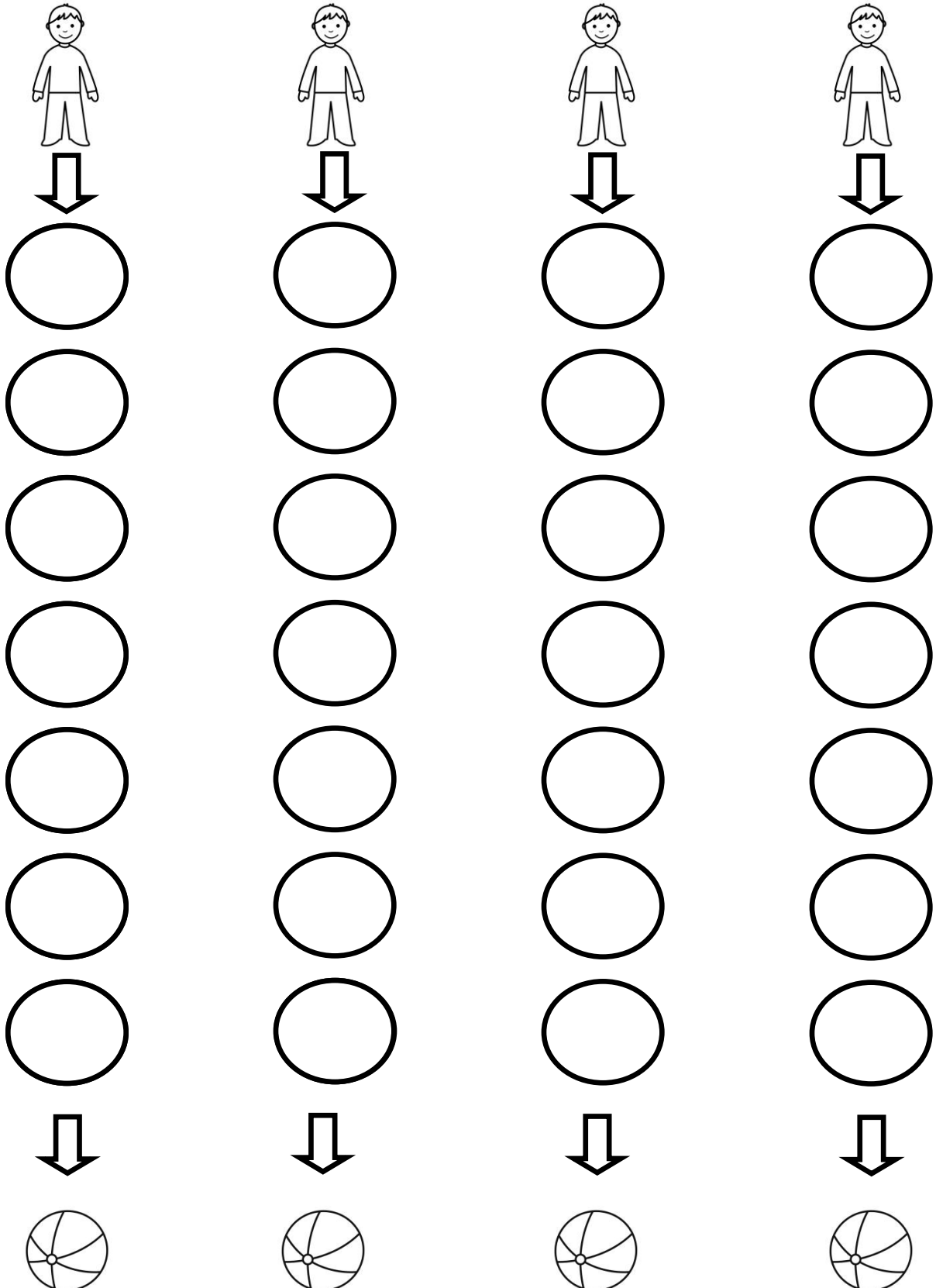

Actividades para mejorar motricidad fina

Sigue con tu lápiz los círculos para unir al niño con su balón

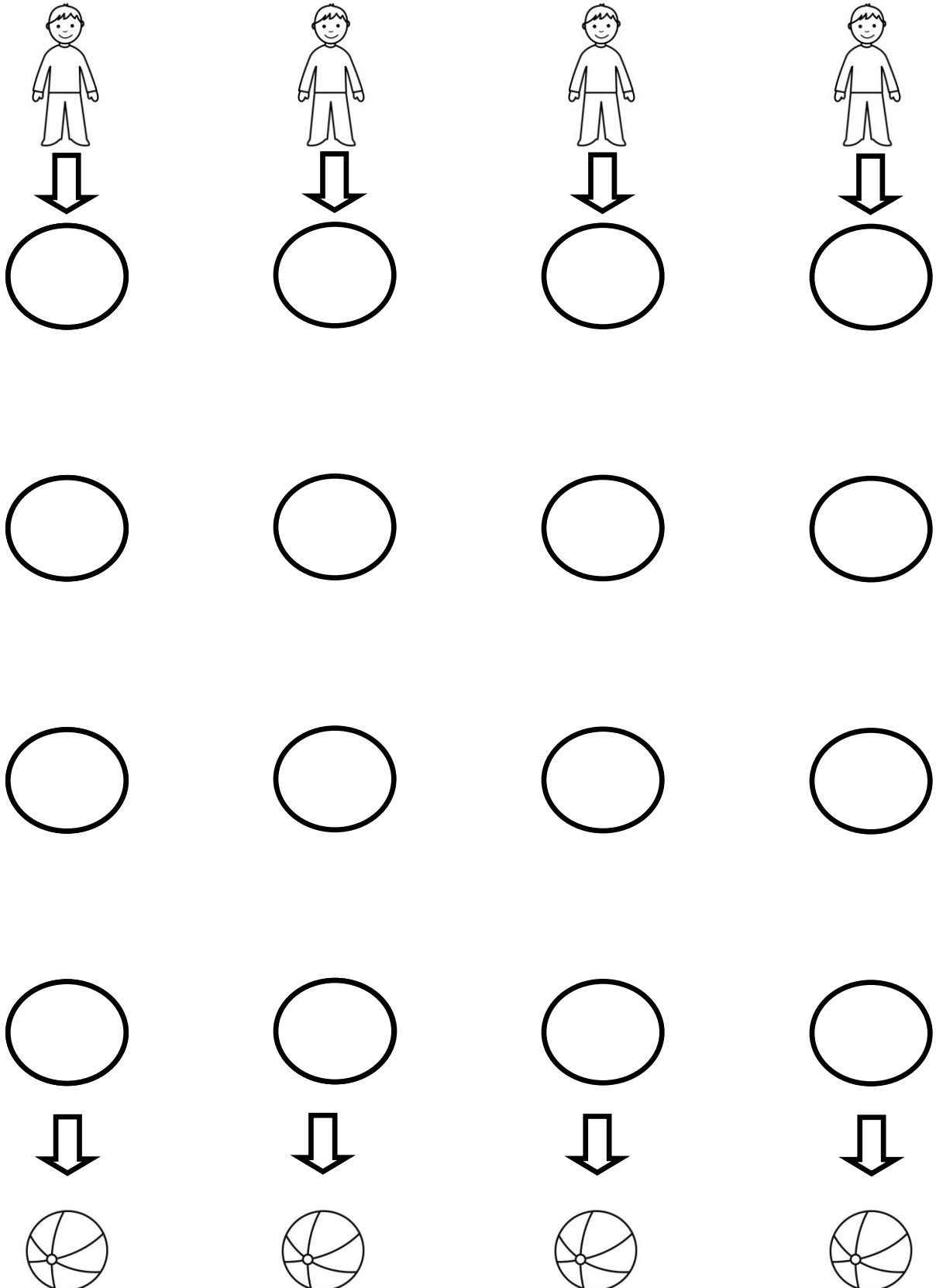

Actividades para mejorar motricidad fina

Sigue con tu lápiz los rayos para unir a nube y la tierra

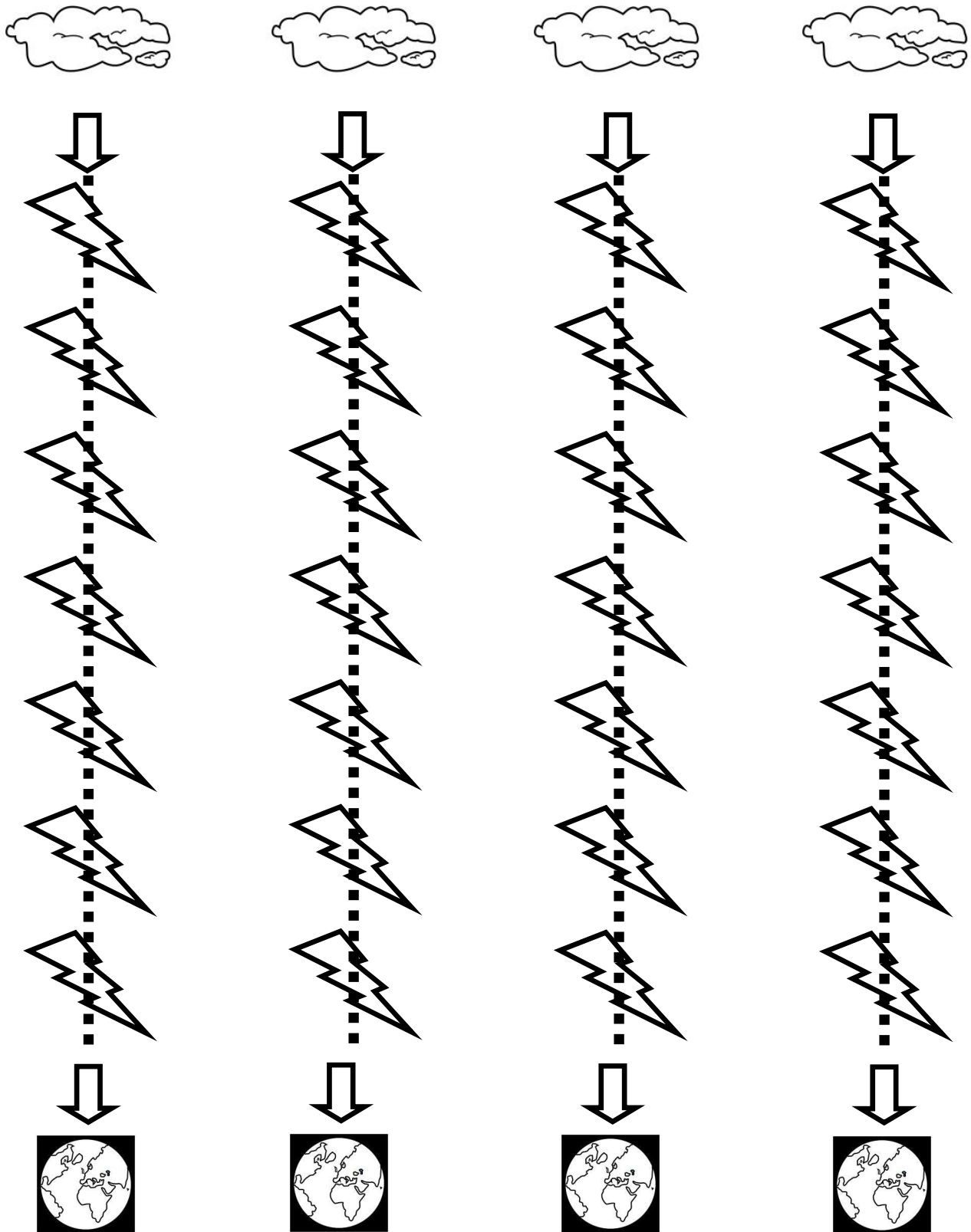

Actividades para mejorar motricidad fina

Sigue con tu lápiz los rayos para unir a nube y la tierra

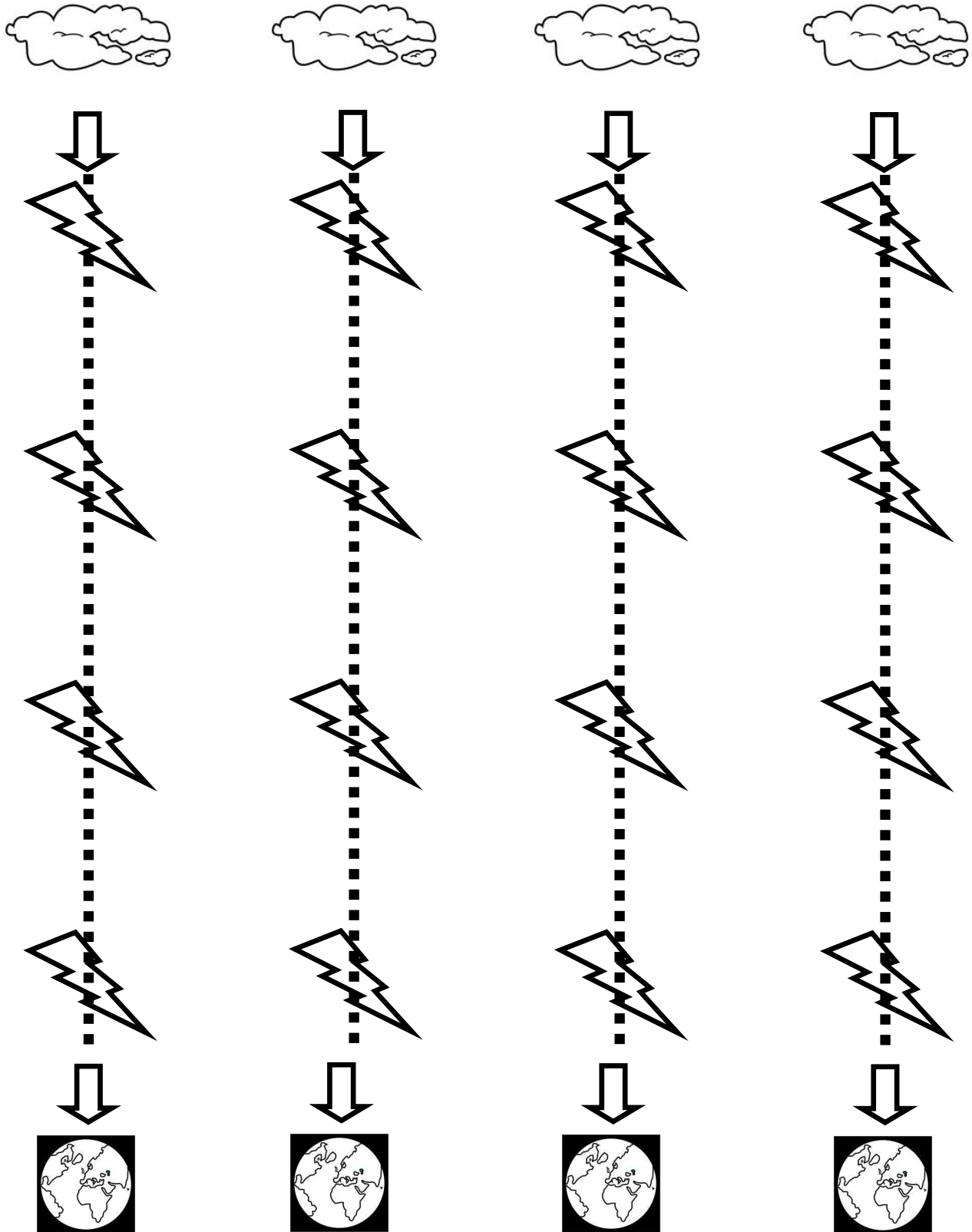

Actividades para mejorar motricidad fina

Sigue con tu lápiz los rayos para unir a nube y la tierra

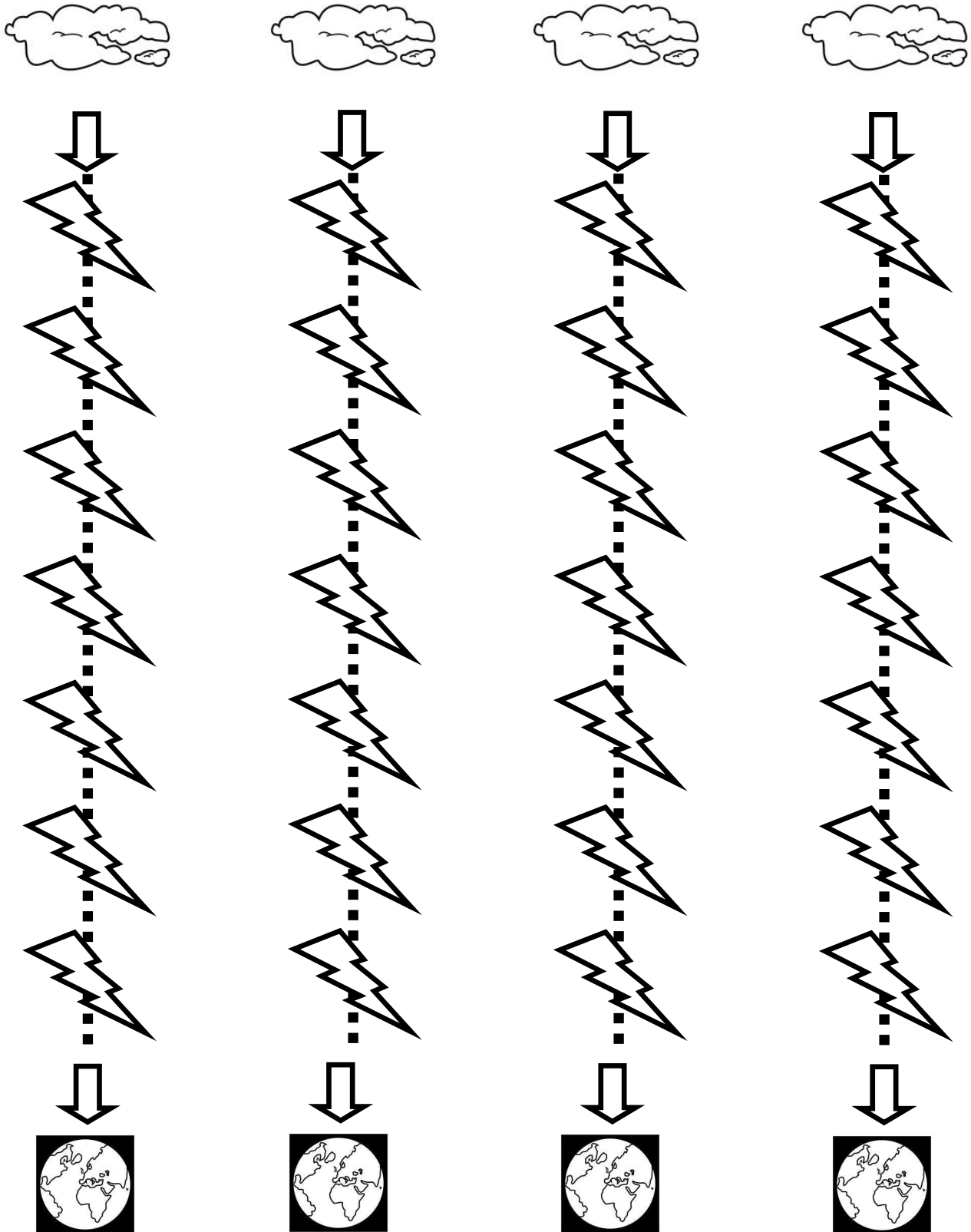

Actividades para mejorar motricidad fina

Sigue con tu lápiz los rayos para unir a nube y la tierra

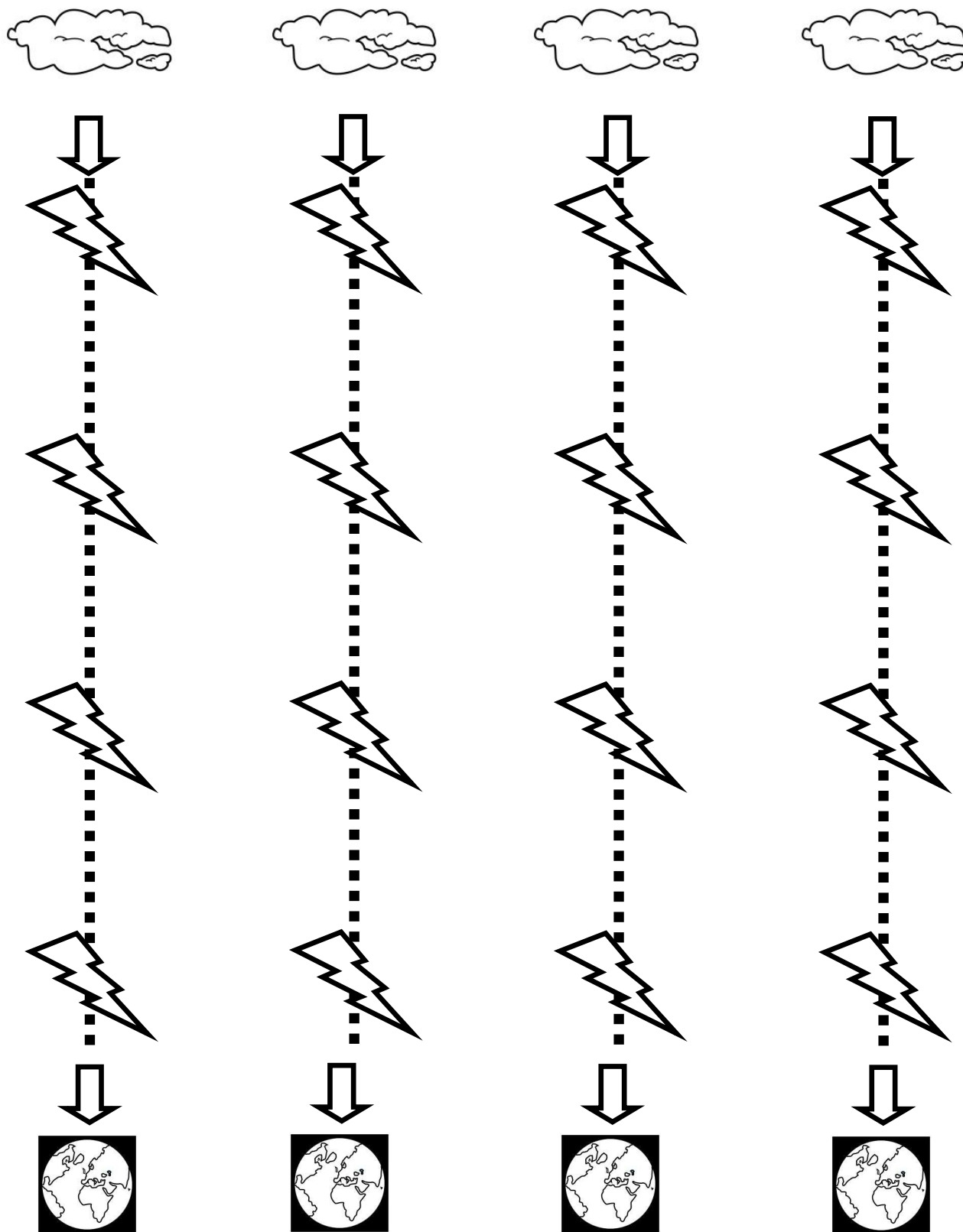

Actividades para mejorar motricidad fina

Sigue con tu lápiz los rayos para unir a nube y la tierra

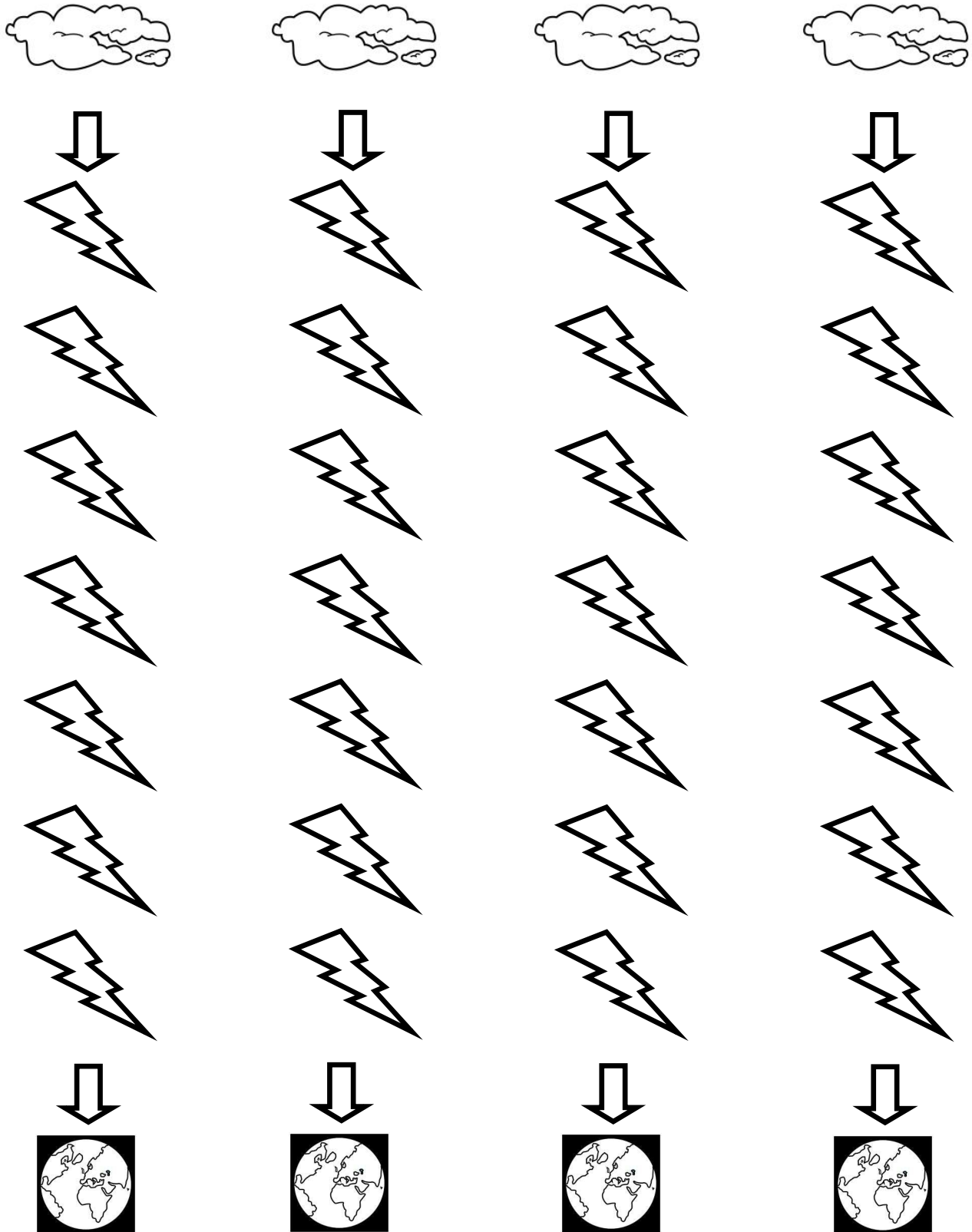

Actividades para mejorar motricidad fina

Sigue con tu lápiz los rayos para unir a nube y la tierra

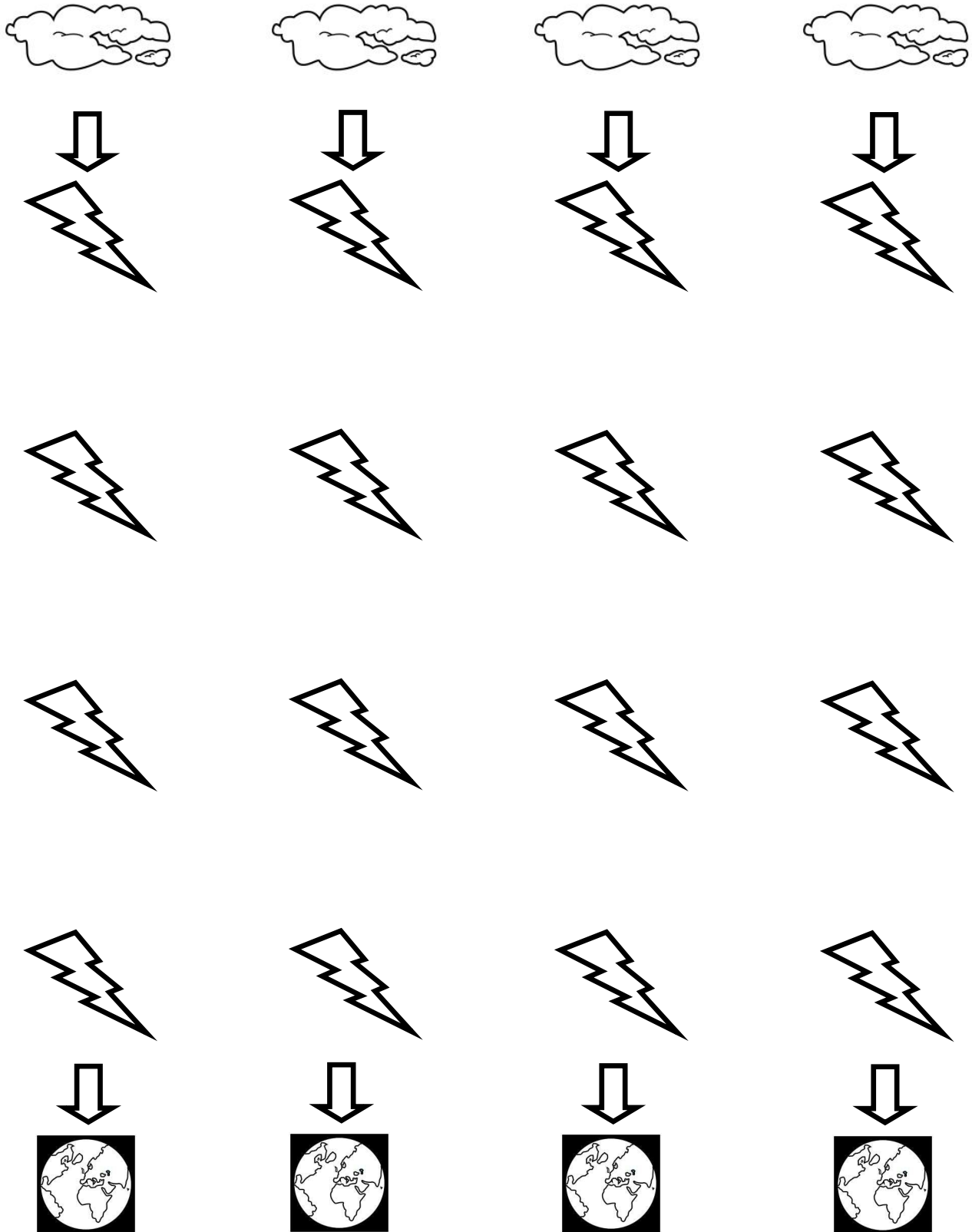

Actividades para mejorar motricidad fina

Sigue con tu lápiz las caras para unir al niño con su amiga

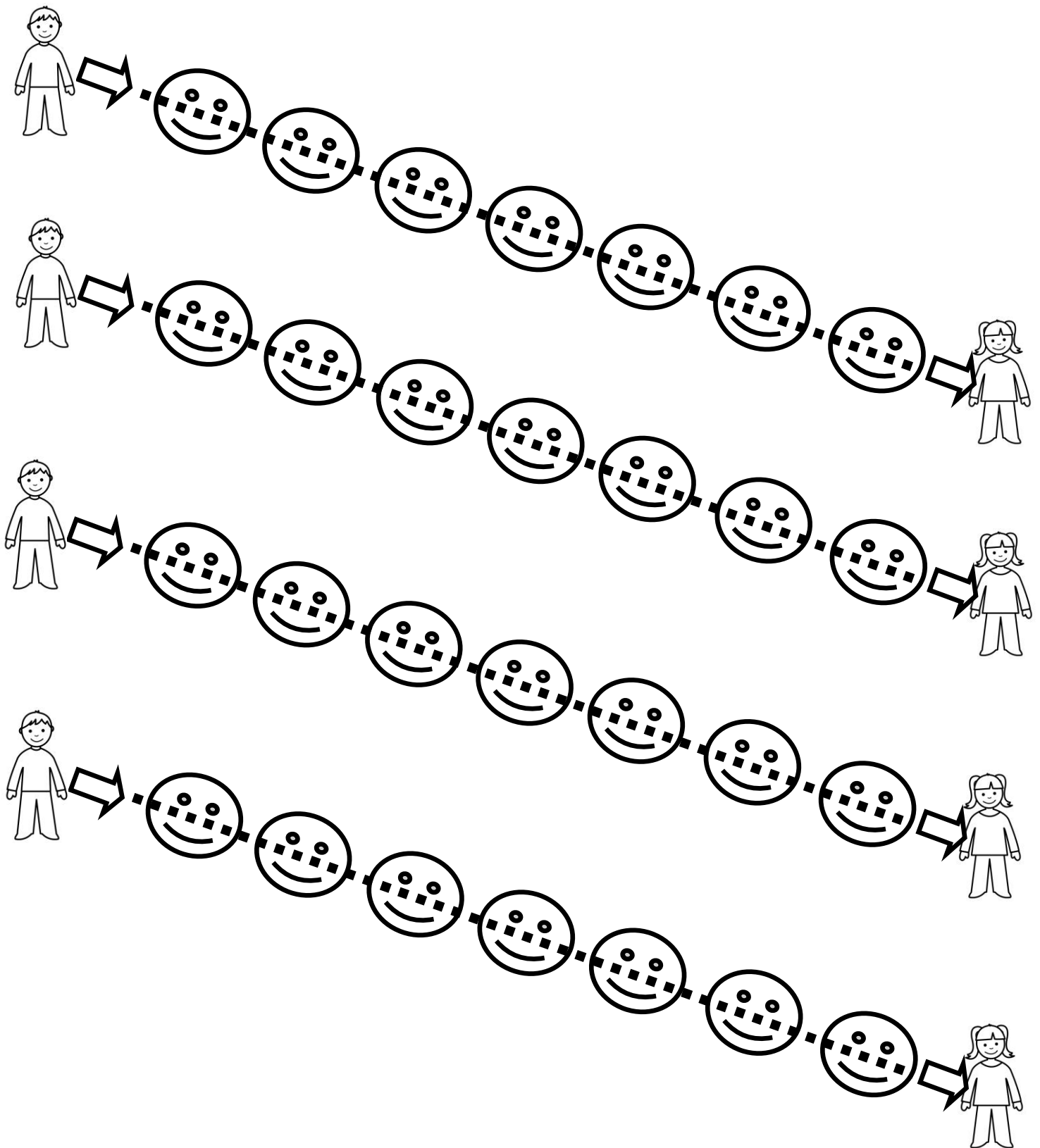

Actividades para mejorar motricidad fina

Sigue con tu lápiz las caras para unir al niño con su amiga

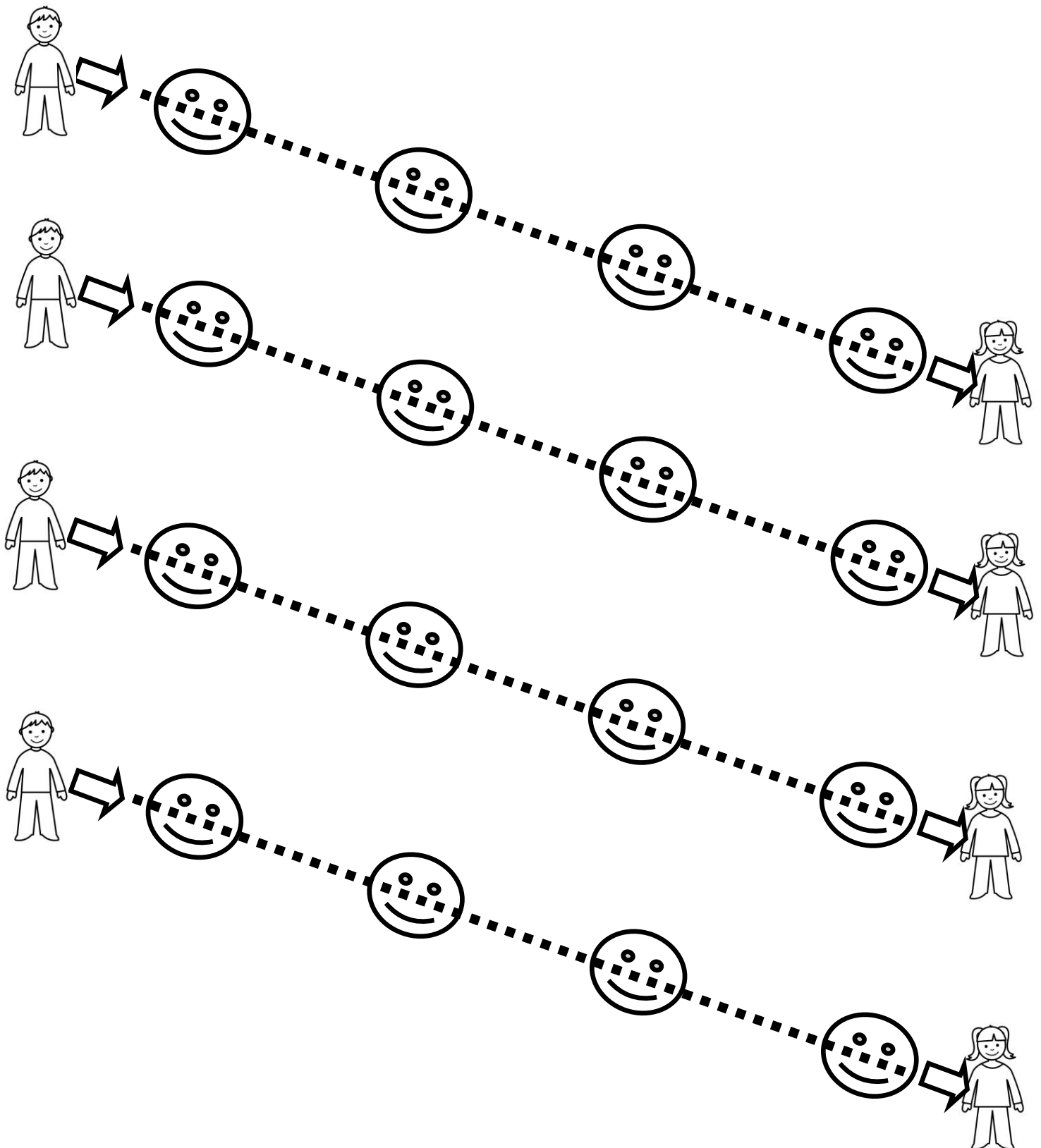

Actividades para mejorar motricidad fina

Sigue con tu lápiz las caras para unir al niño con su amiga

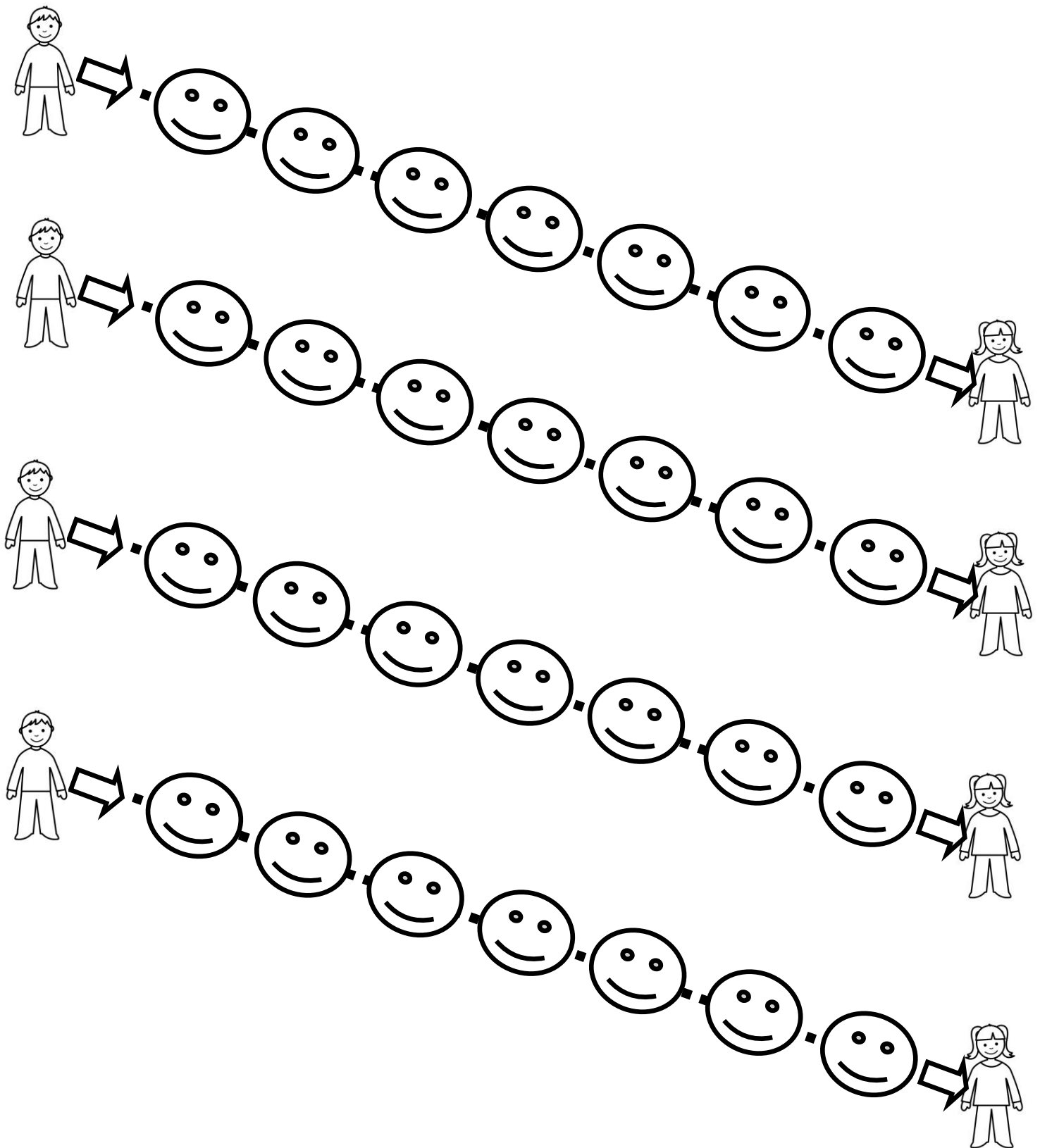

Actividades para mejorar motricidad fina

Sigue con tu lápiz las caras para unir al niño con su amiga

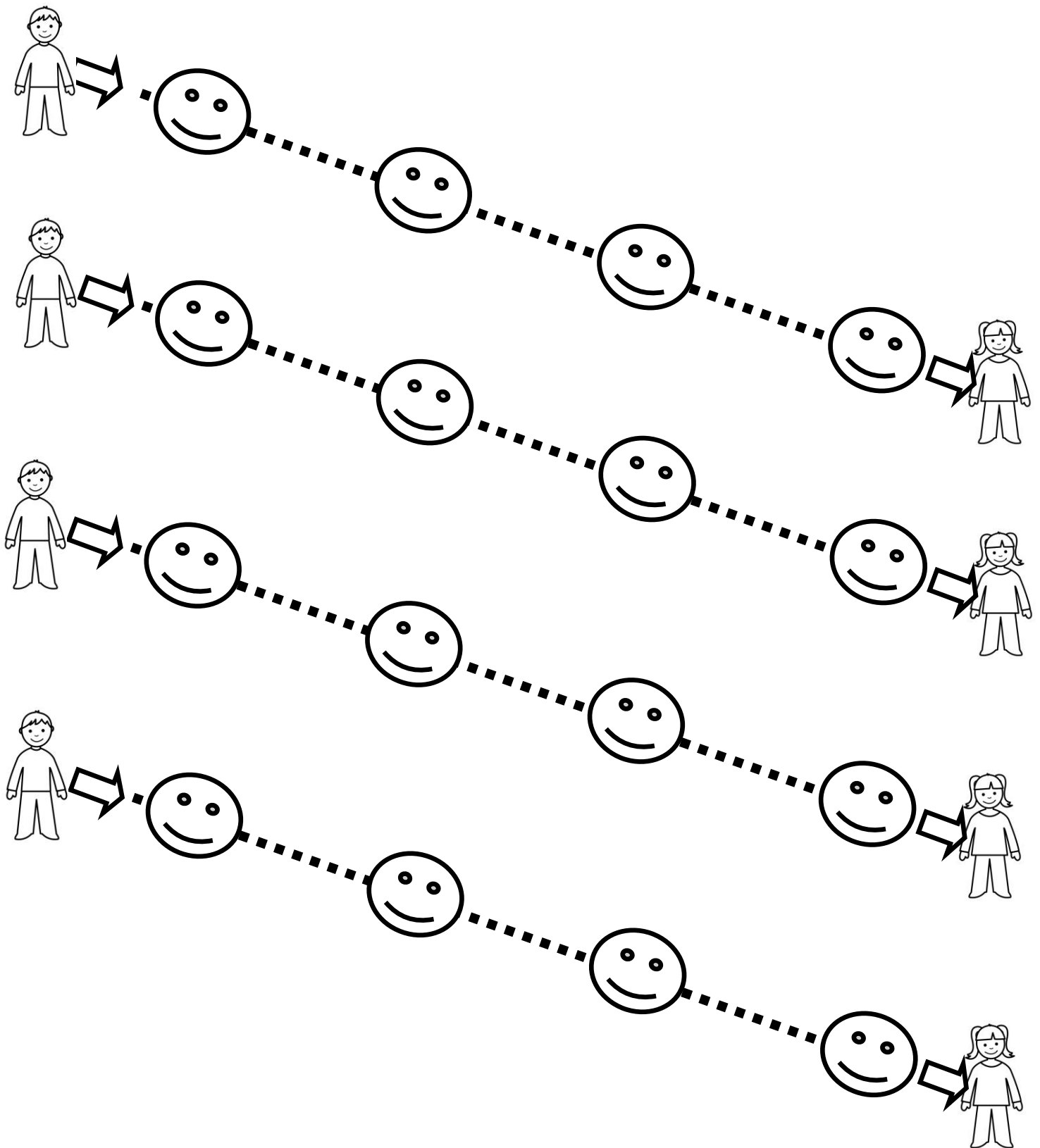

Actividades para mejorar motricidad fina

Sigue con tu lápiz las caras para unir al niño con su amiga

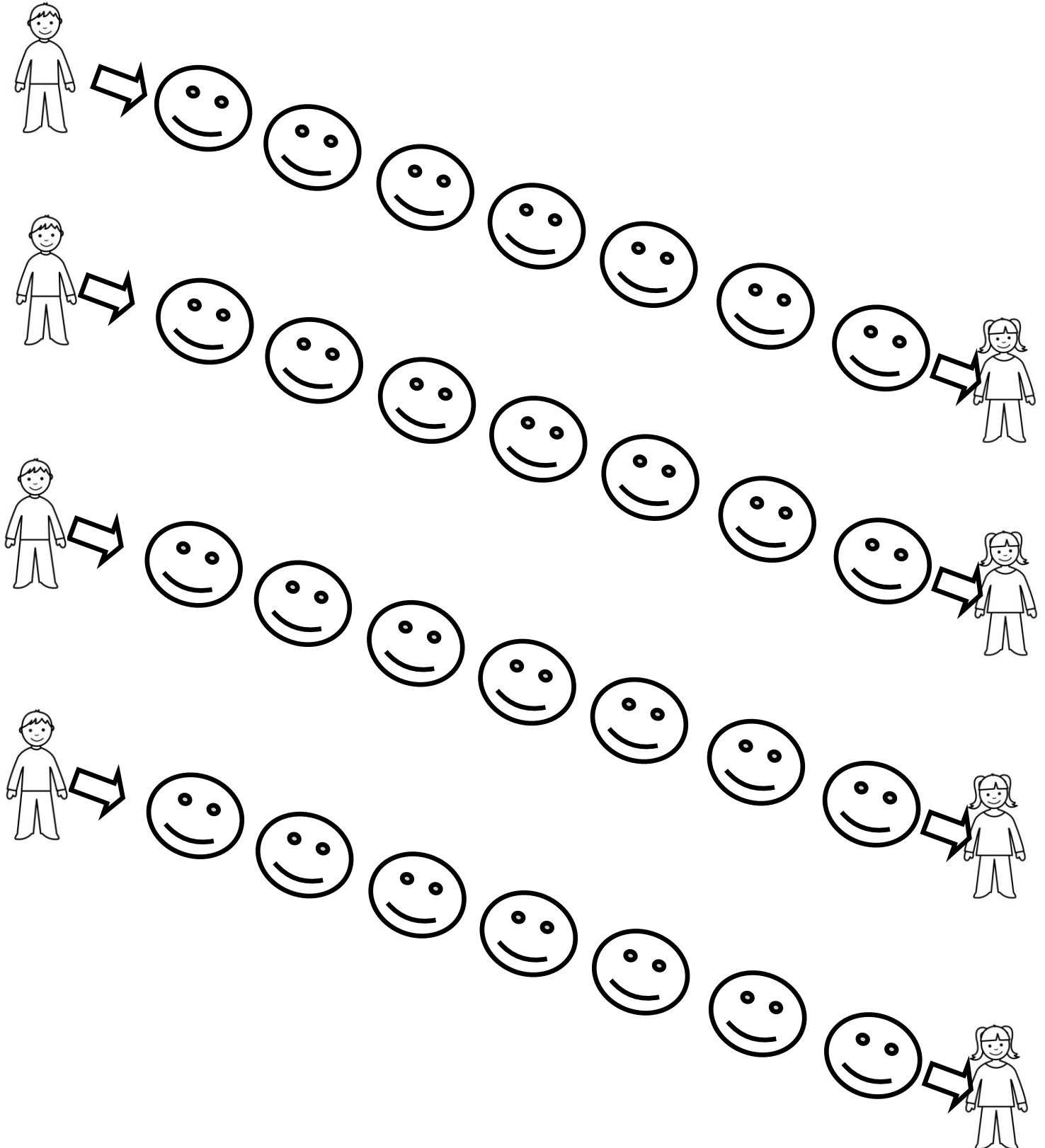

Actividades para mejorar motricidad fina

Sigue con tu lápiz las caras para unir al niño con su amiga

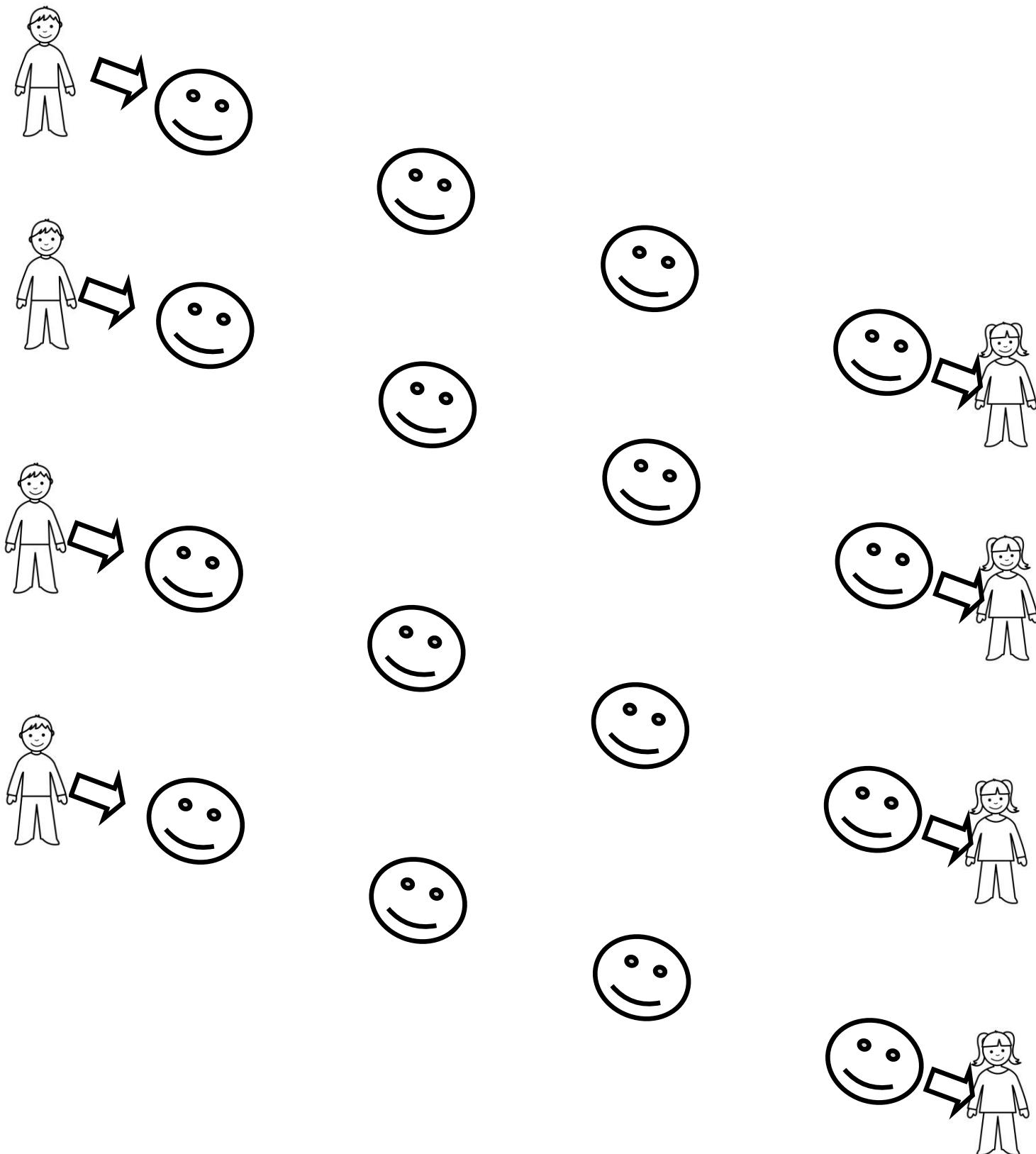

gota

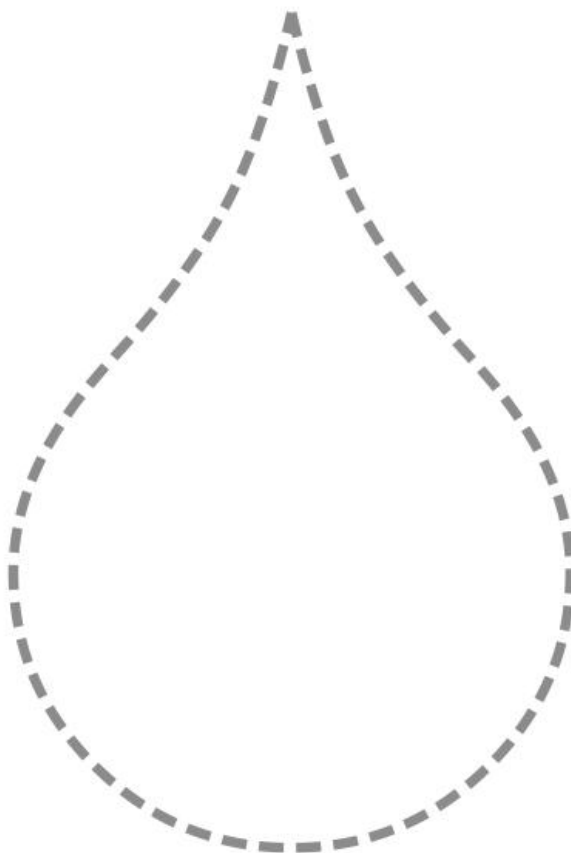

hexágono

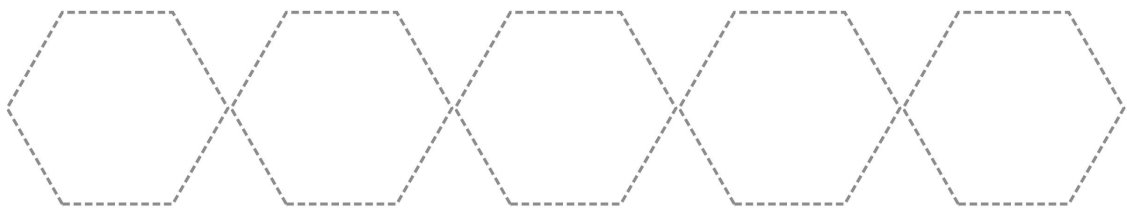
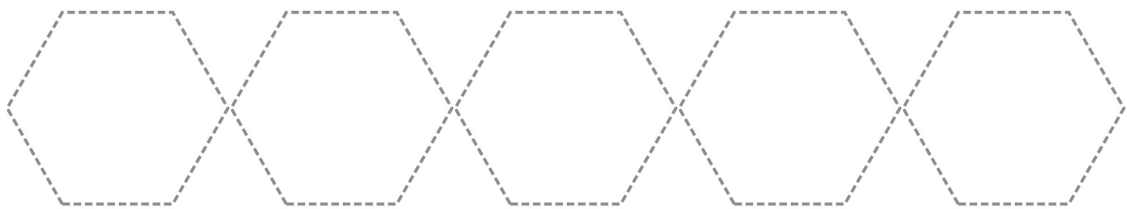
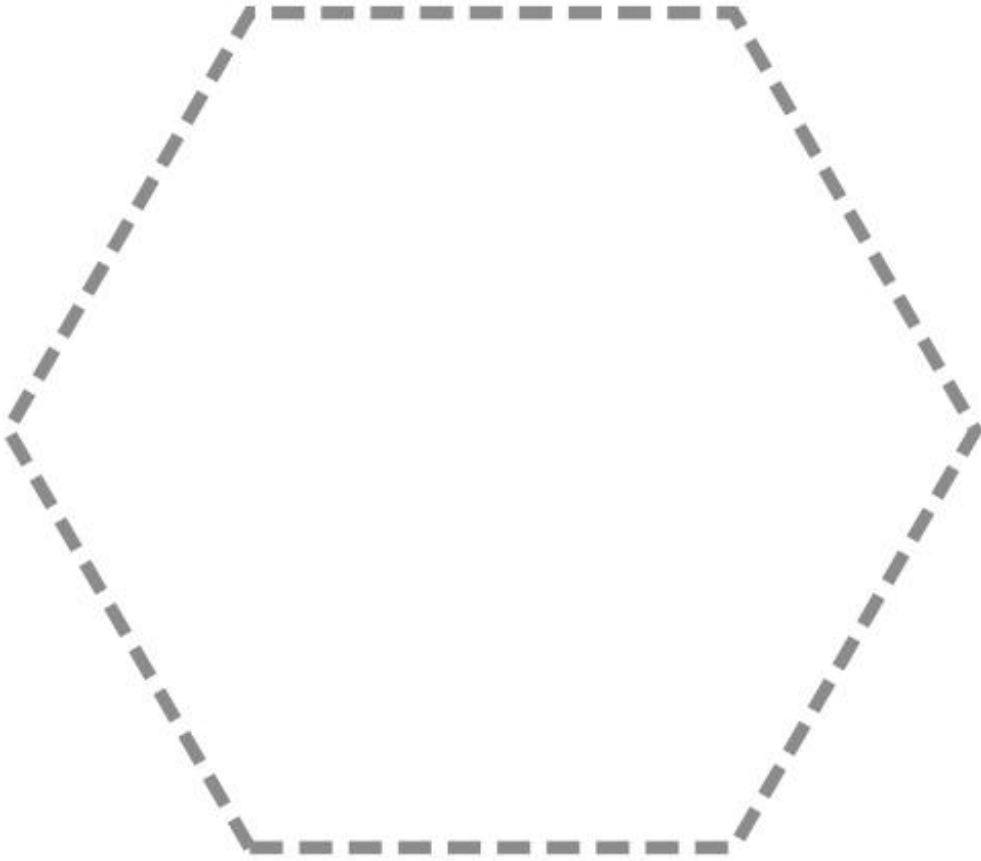

Escudo

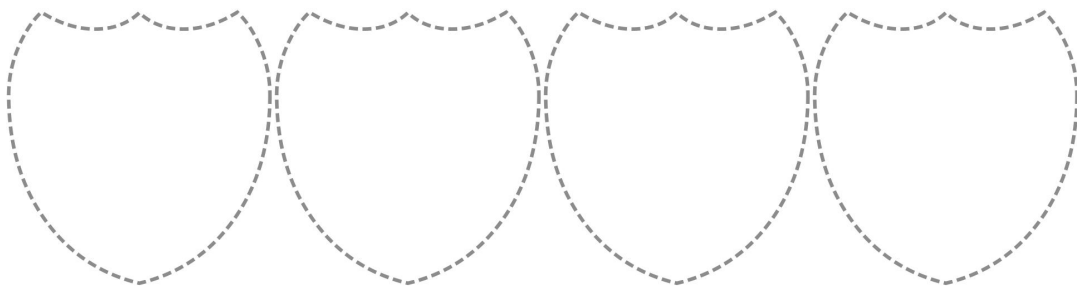
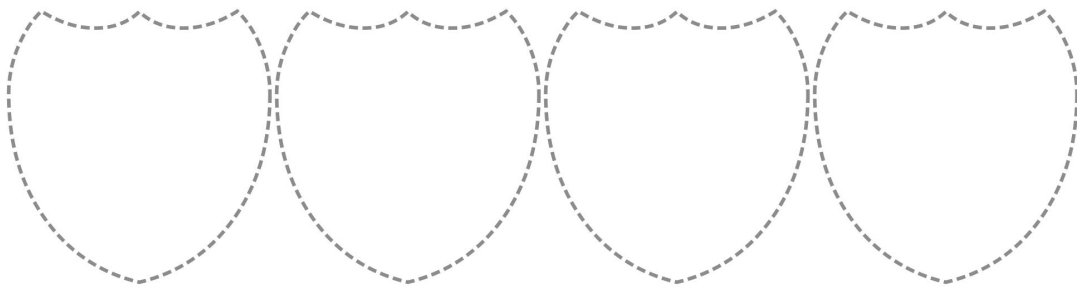
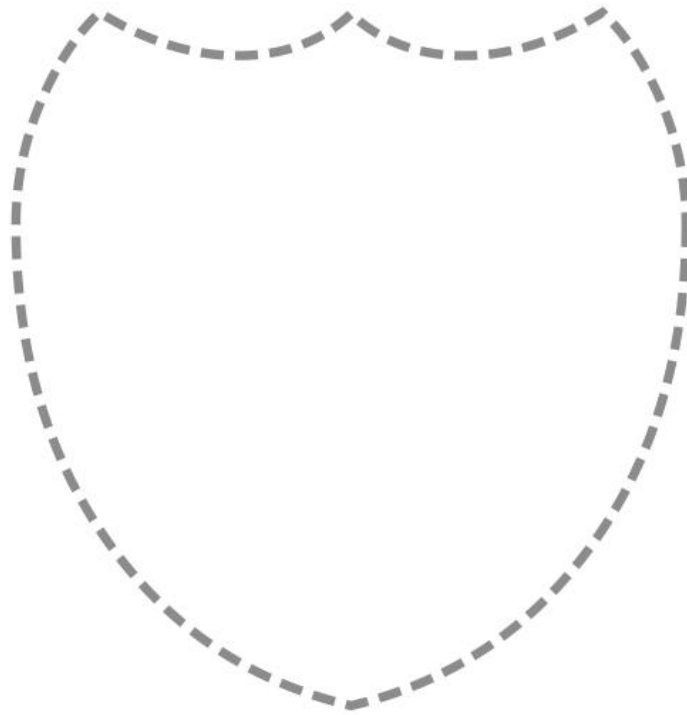

triángulo

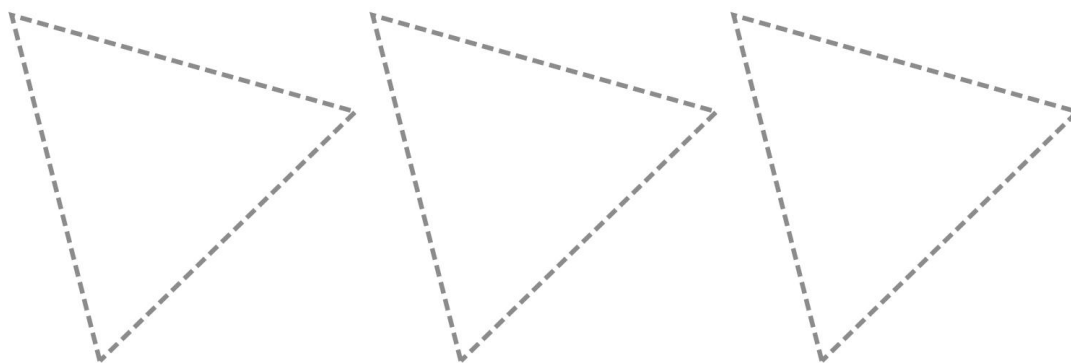
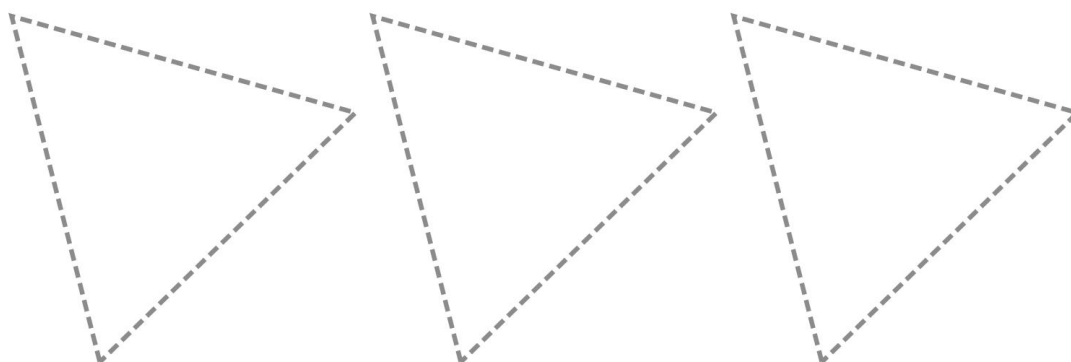
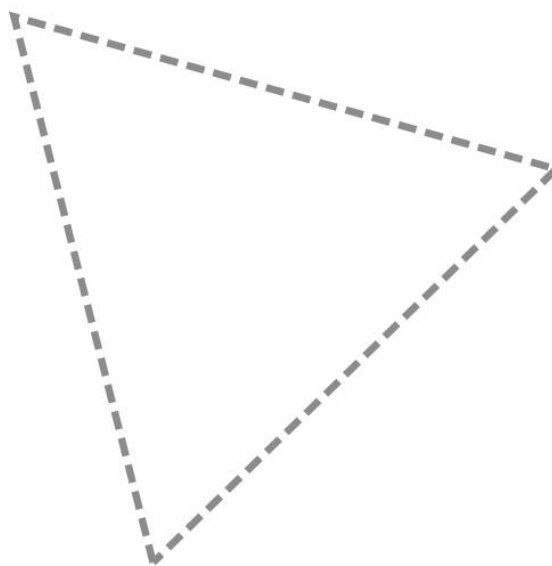

trapezio



triángulo

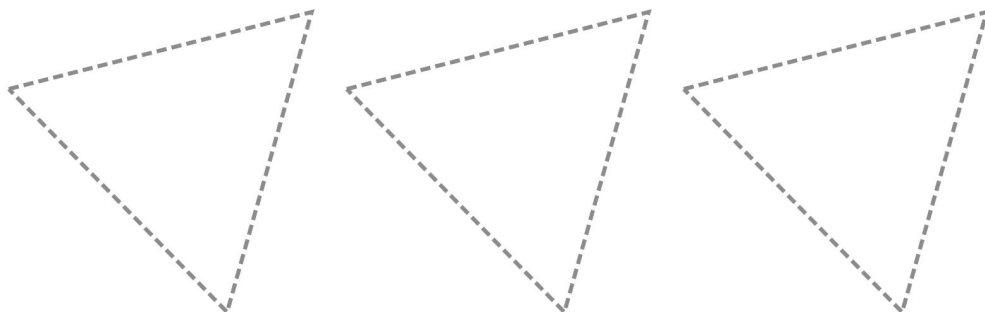
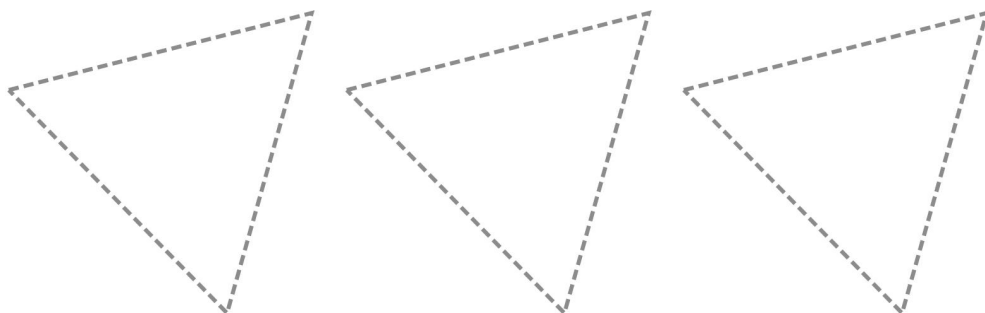
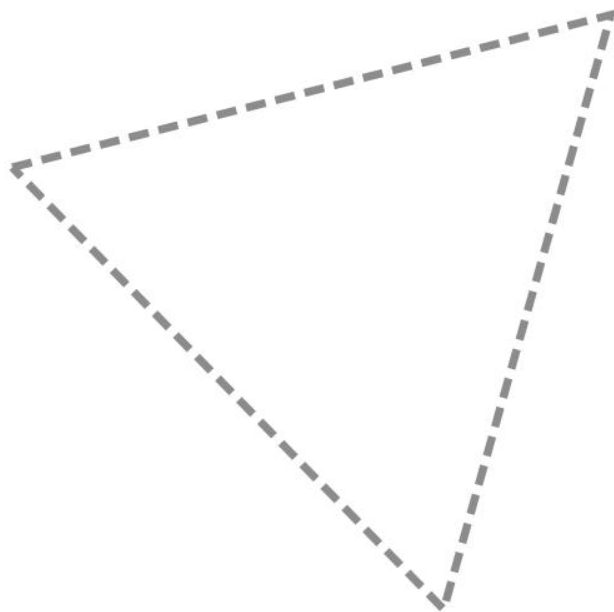

Cuadrado

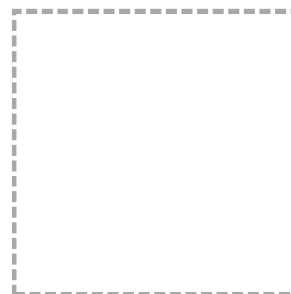

Rombo

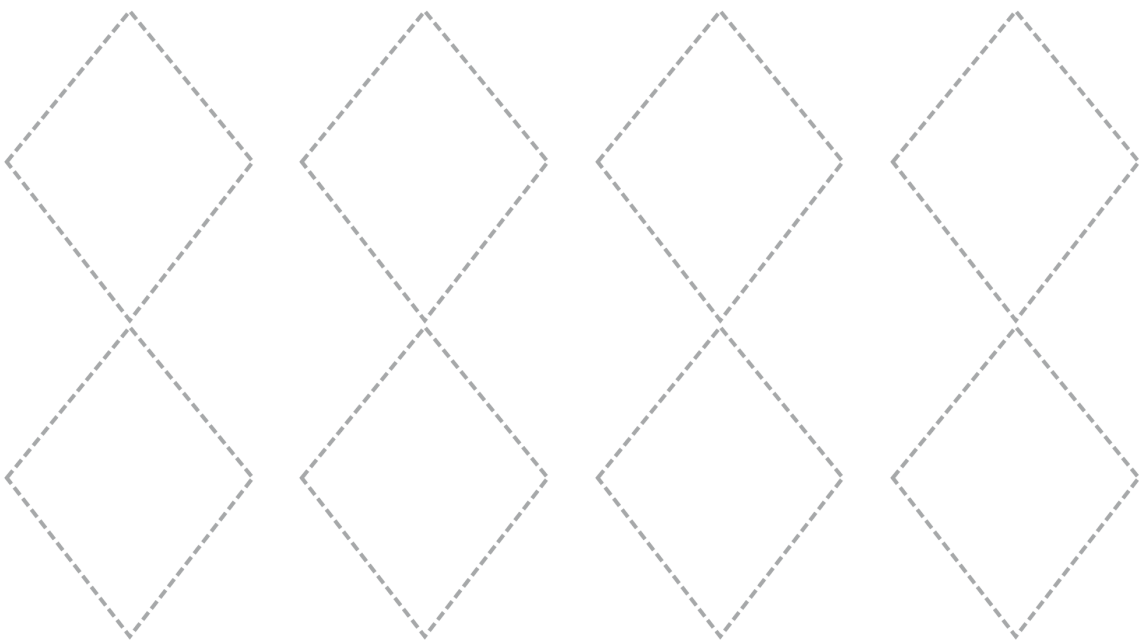
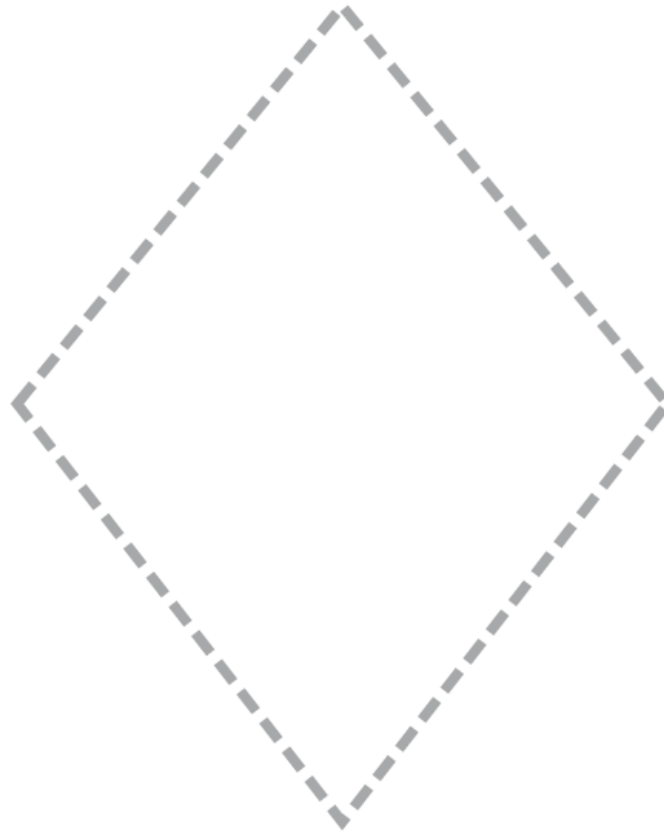

Triángulo

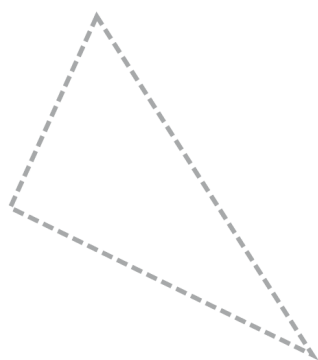
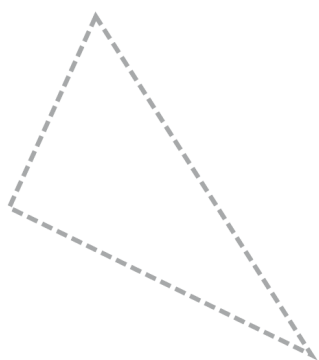
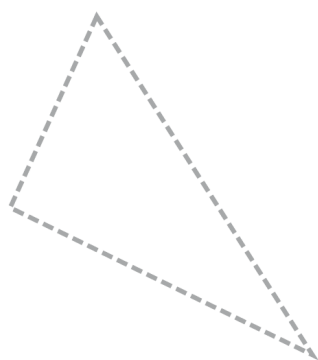
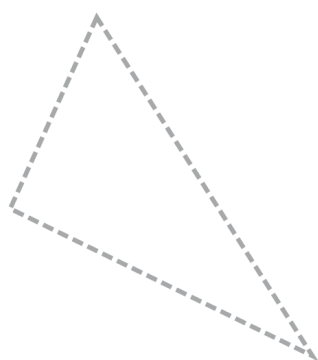
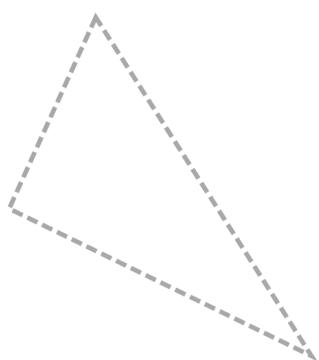
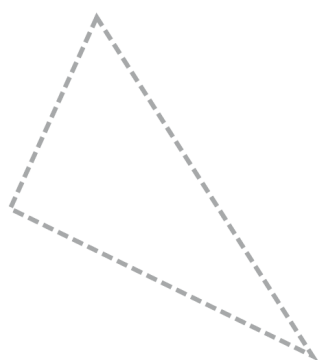
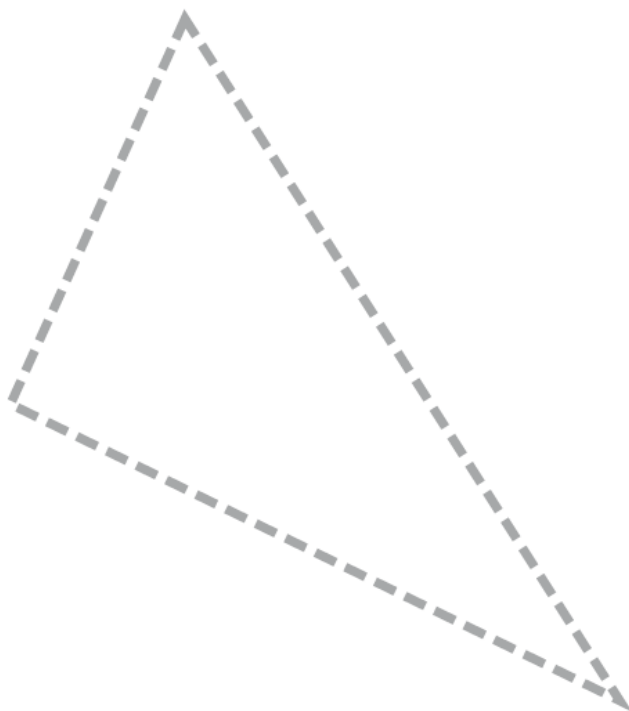

Comecocos

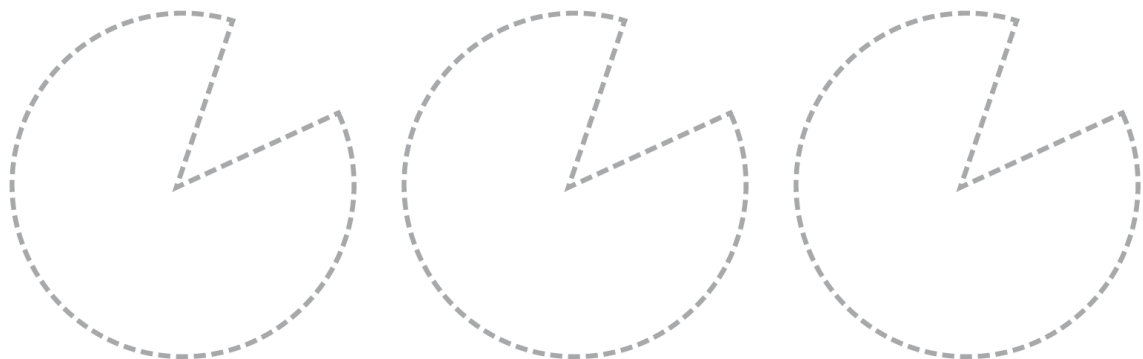
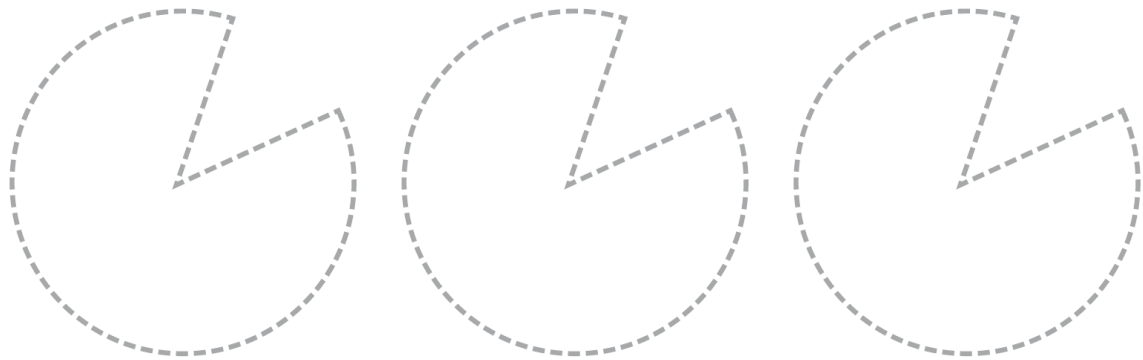

Avión



Estrella

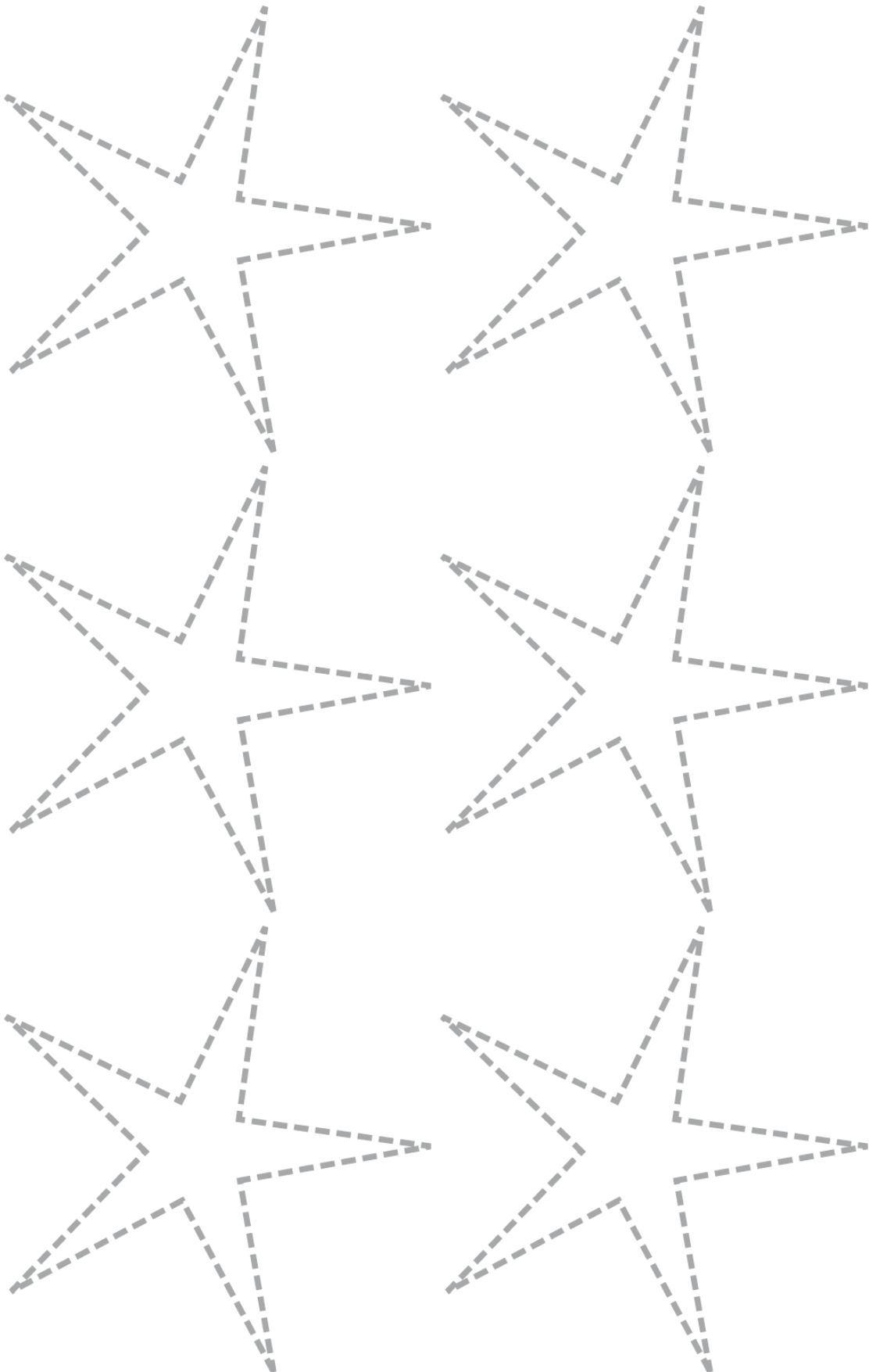

Octógono

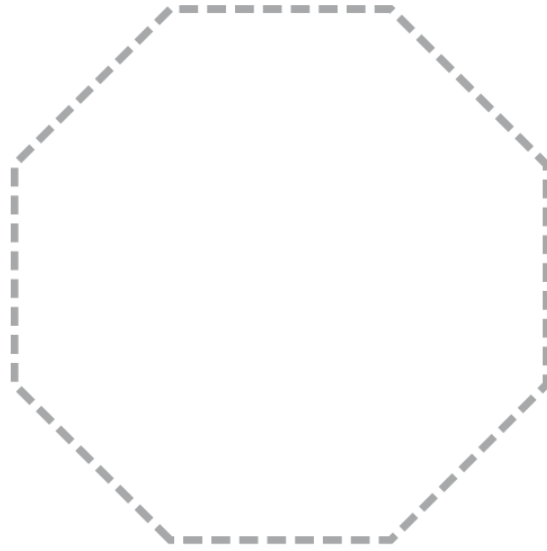

Martillo



Pentágono

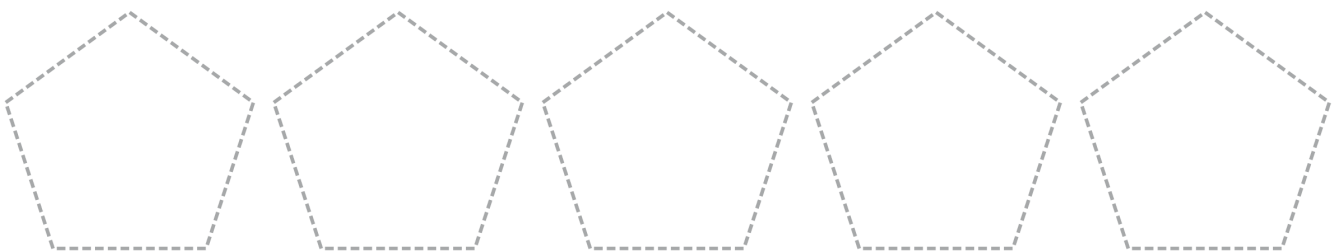
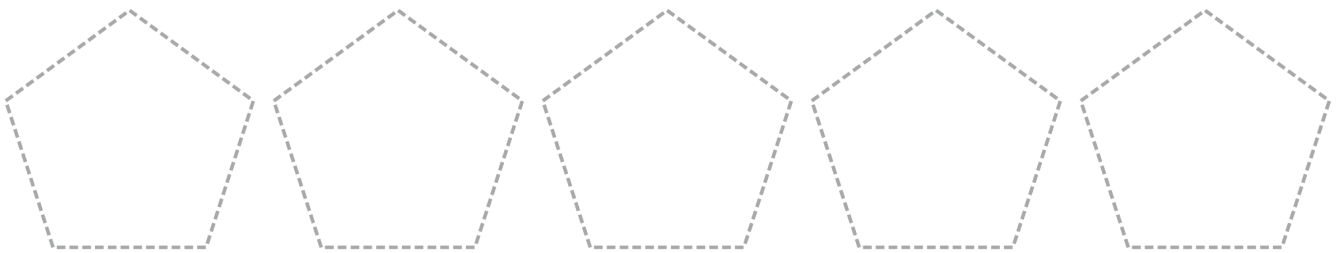
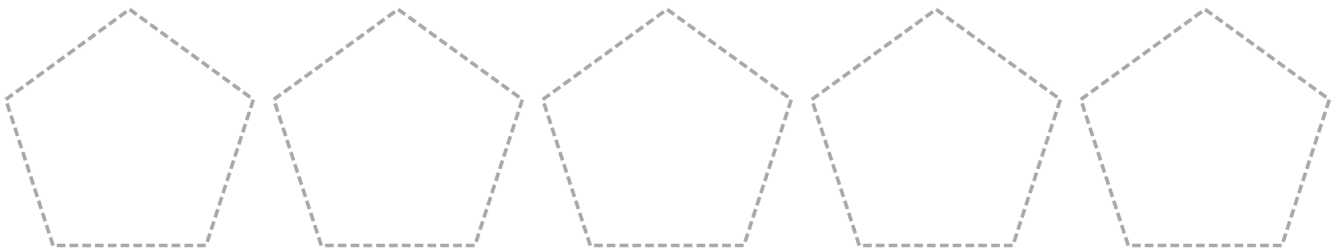
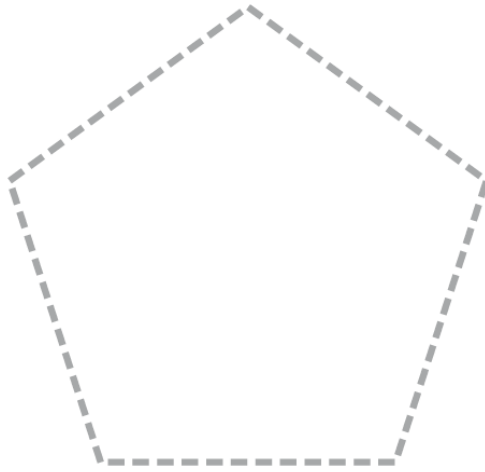

Corazón



Rayo

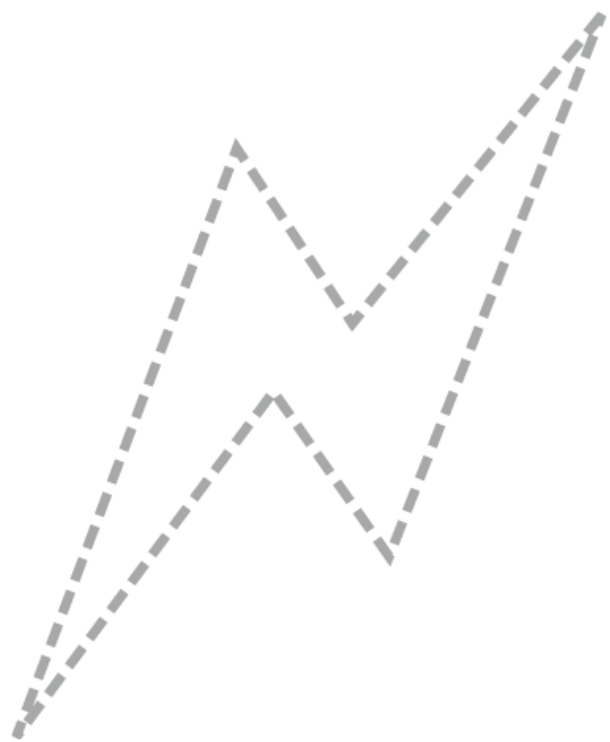
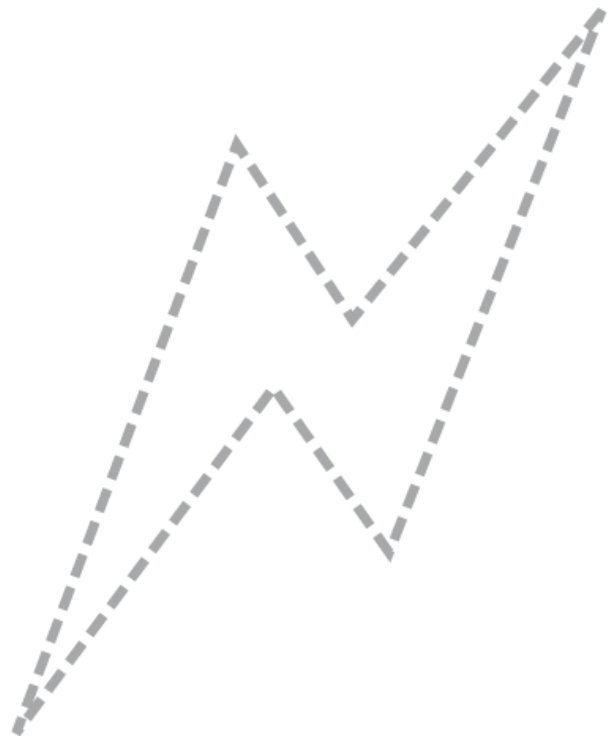
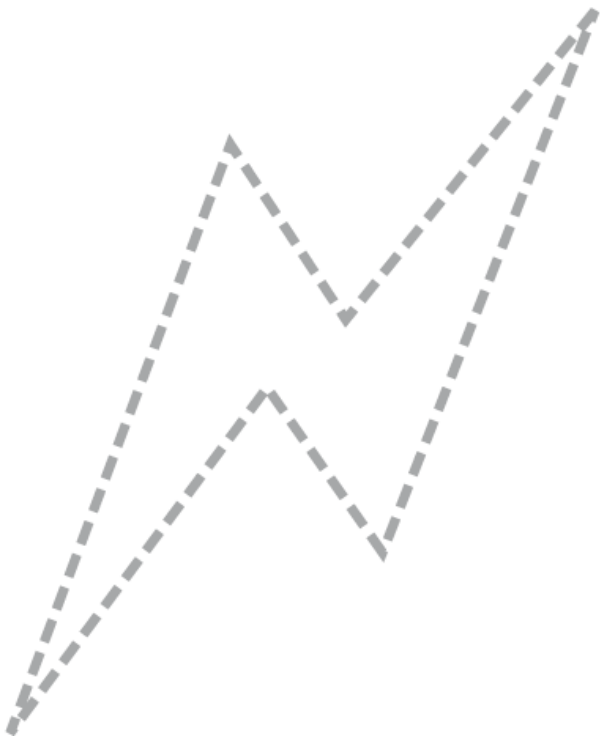

Espiral

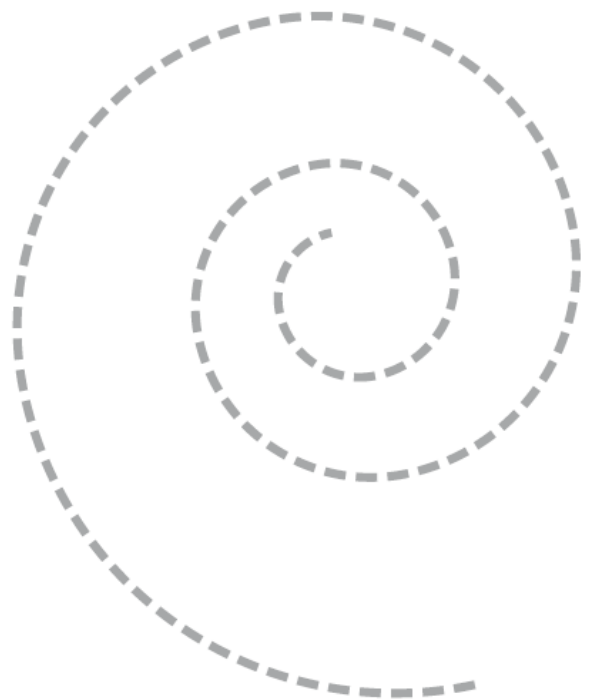
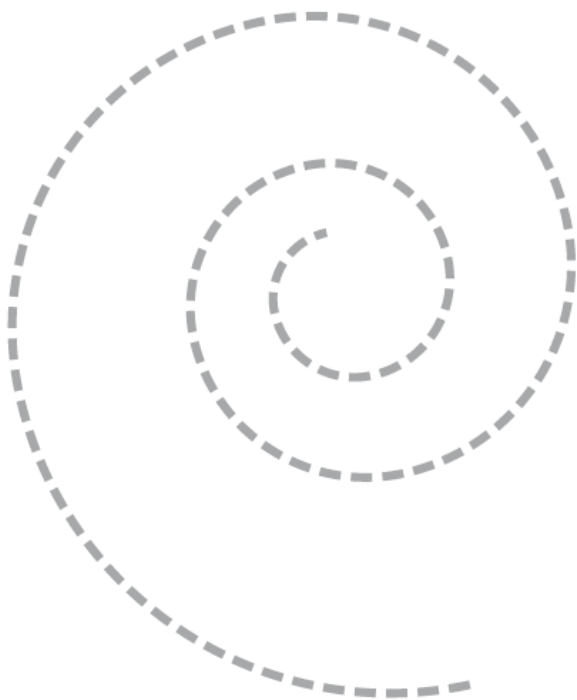
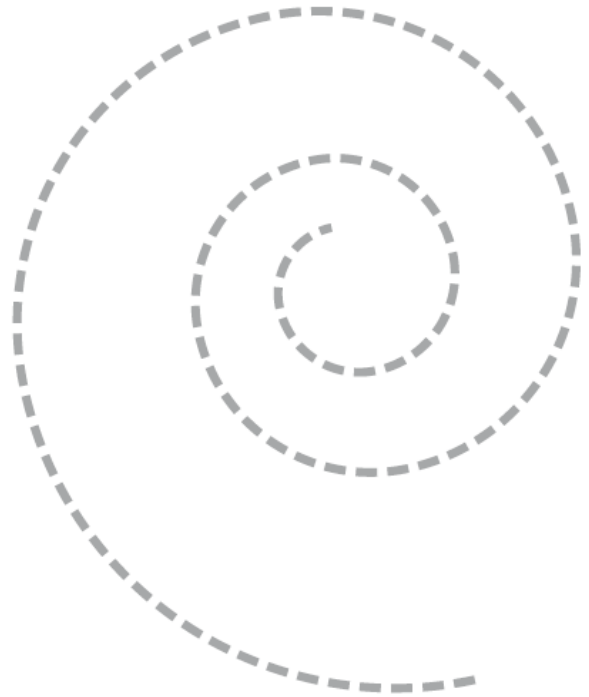
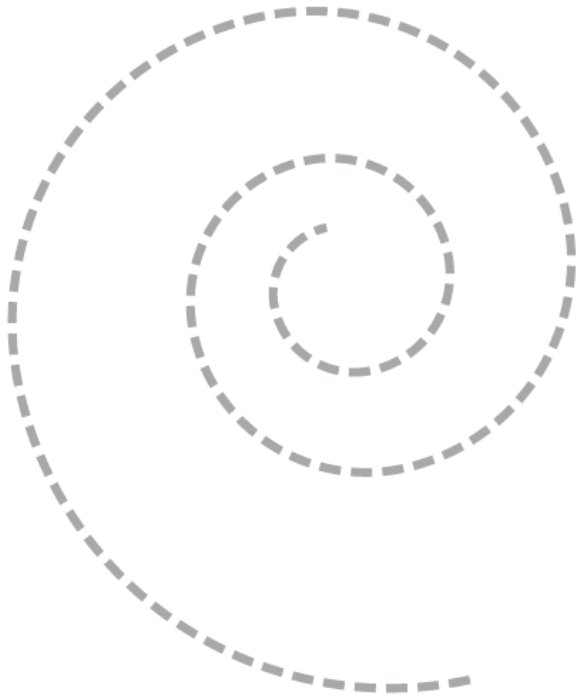

Flor

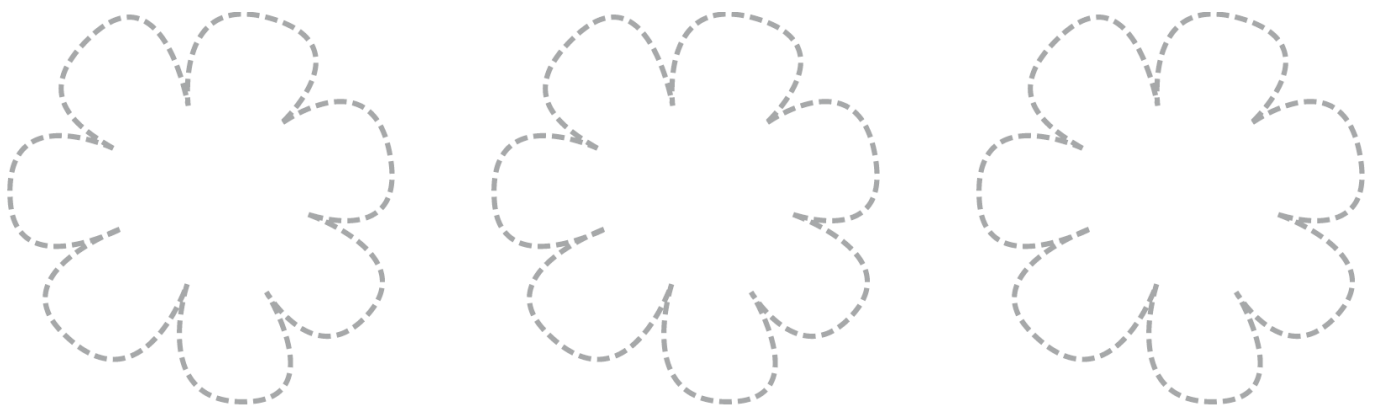
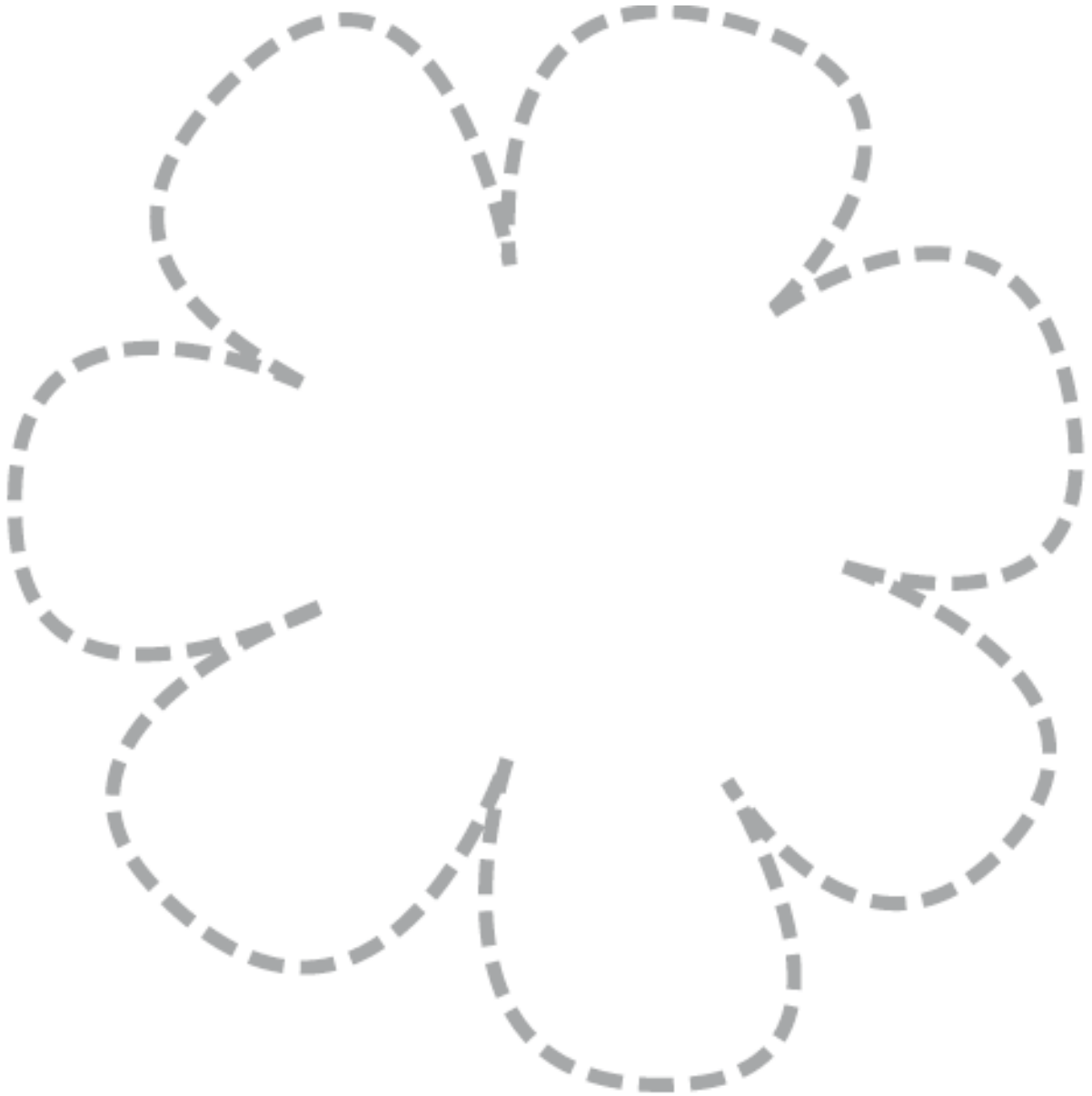

Flor

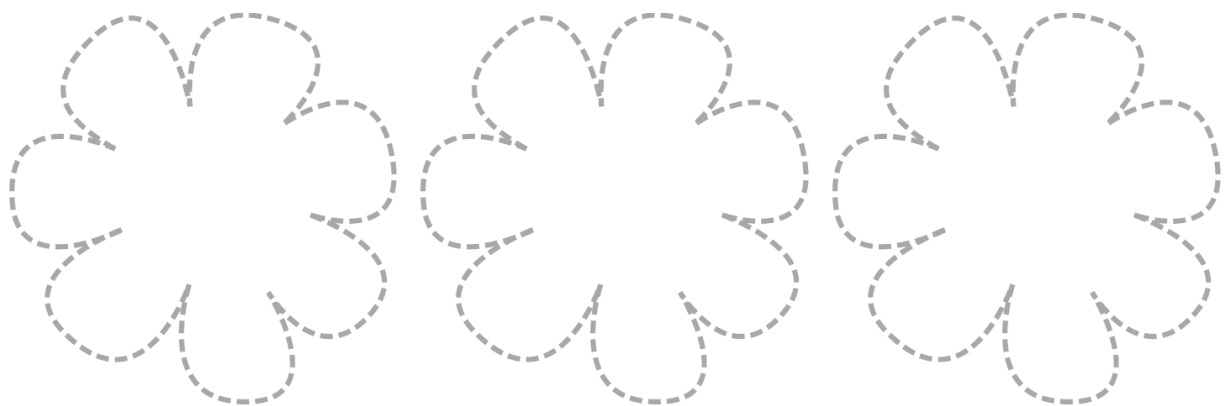
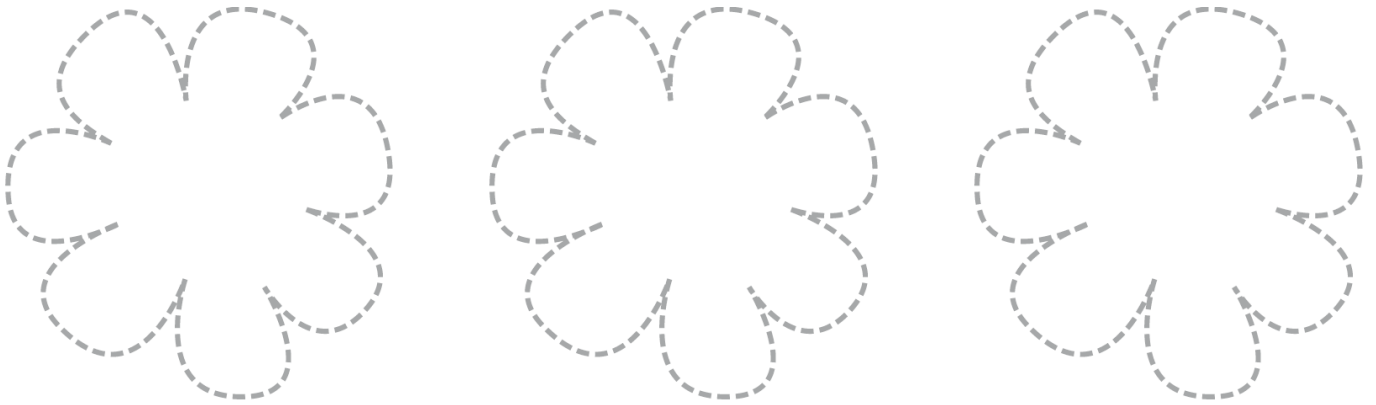

Flecha

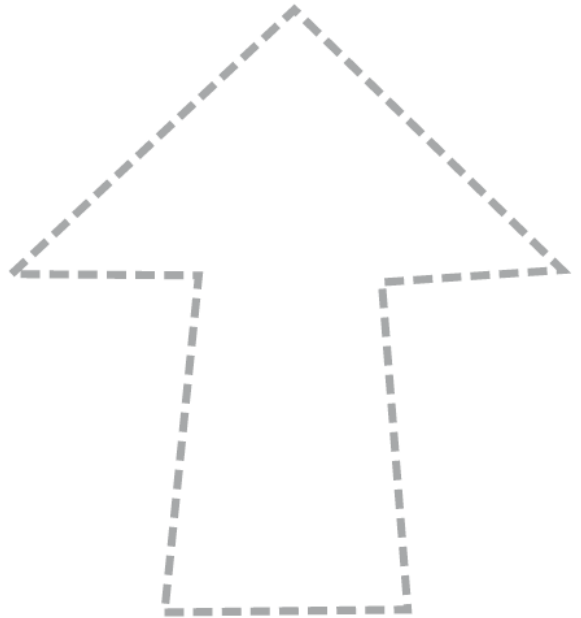
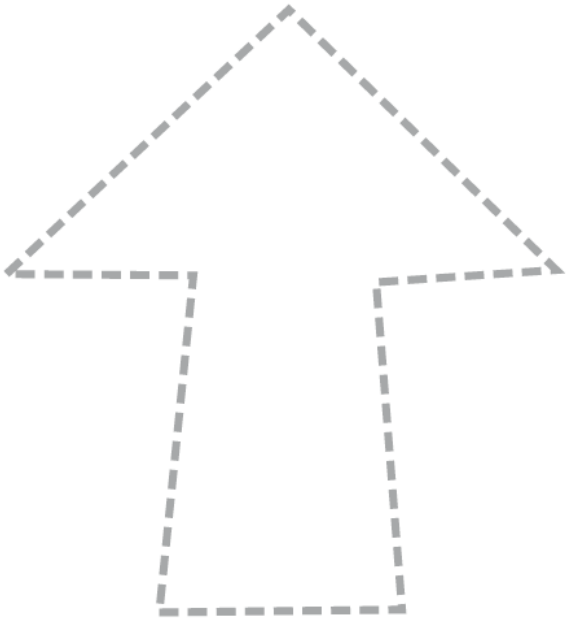
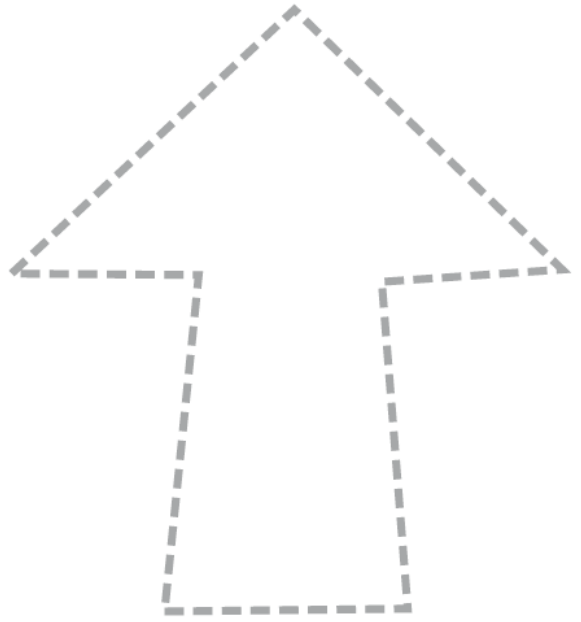
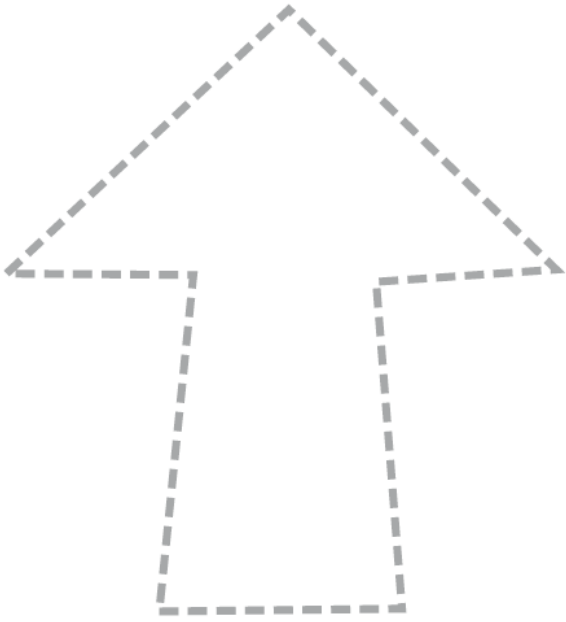

Flecha

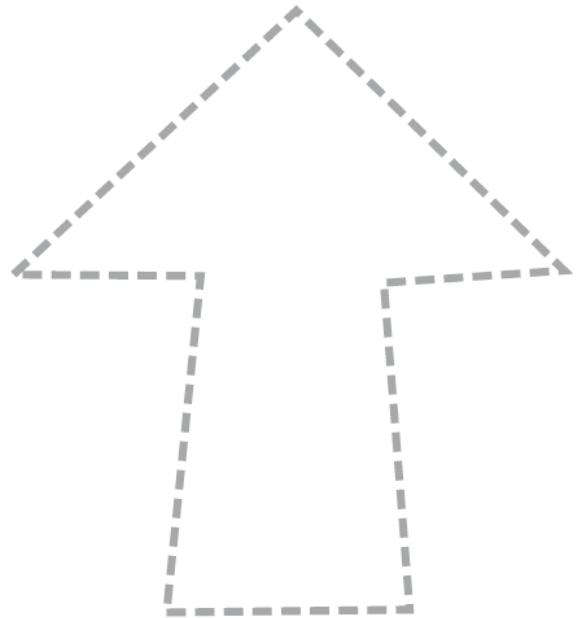
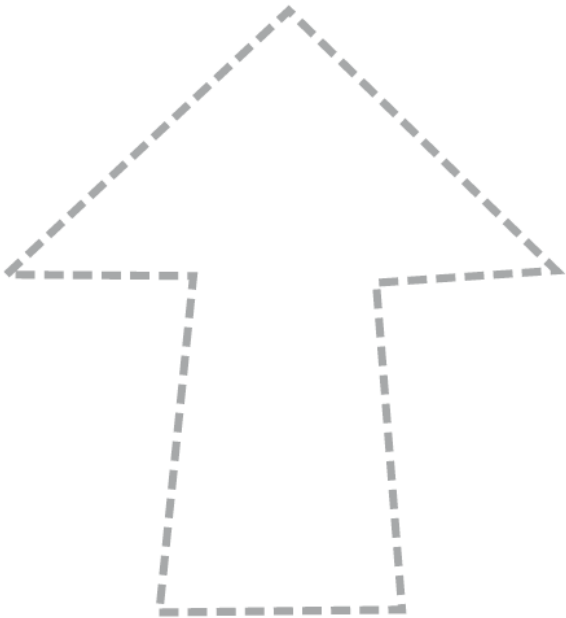
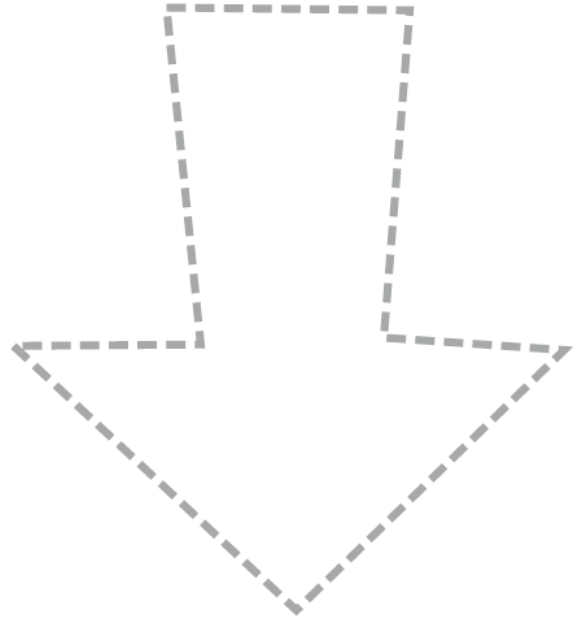
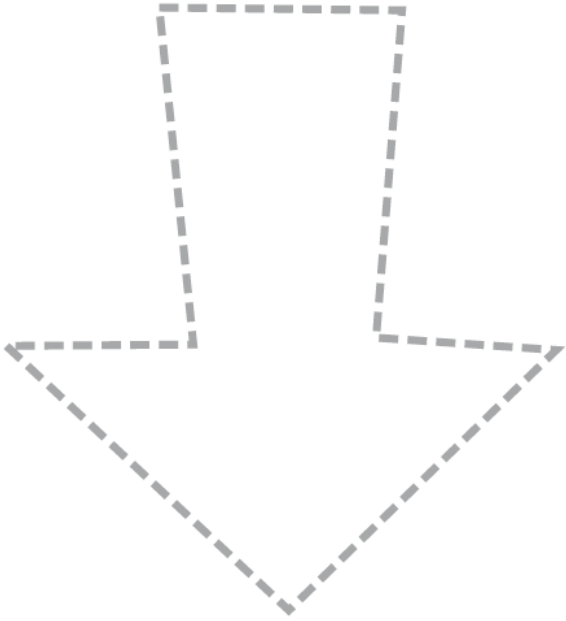

Flecha

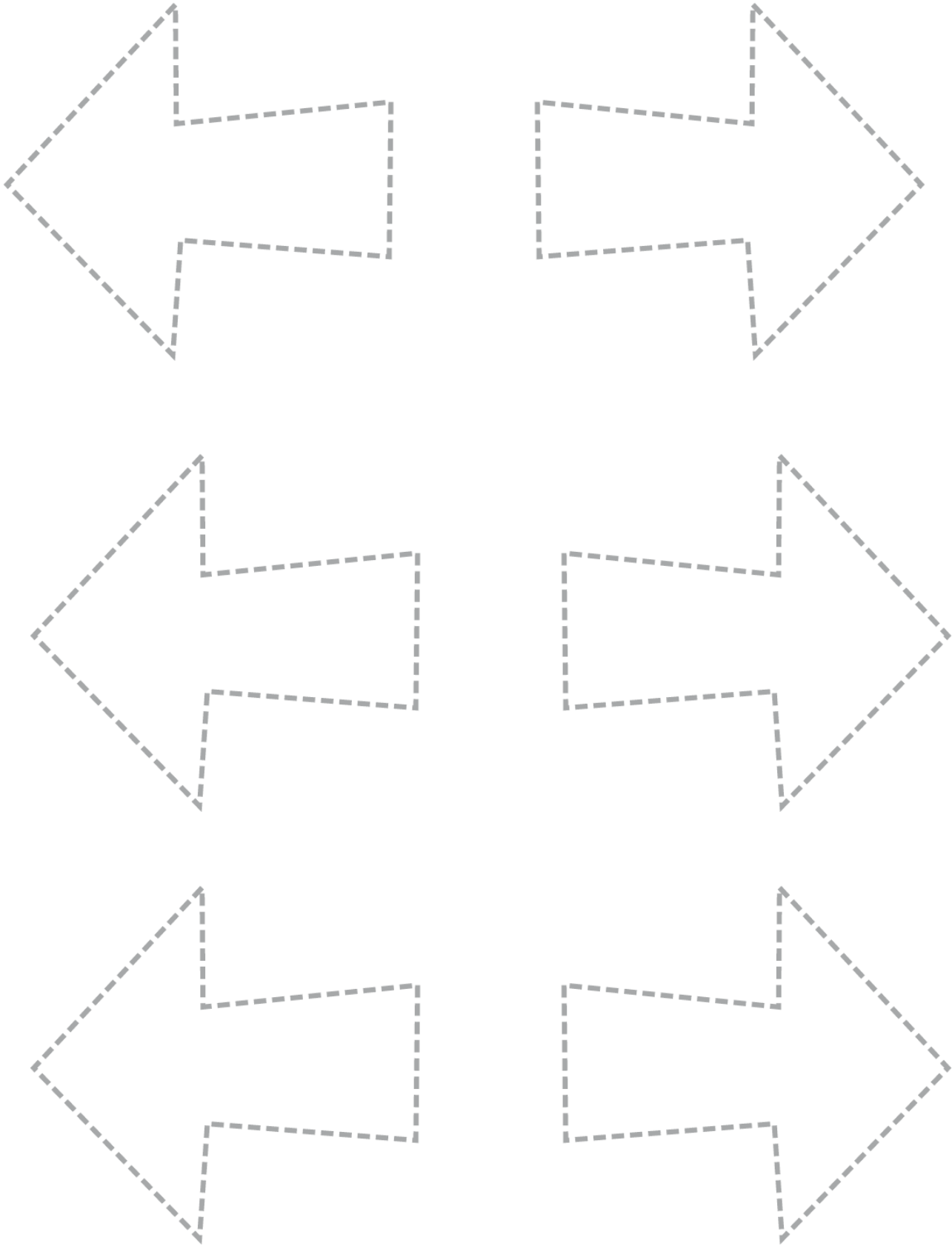

Palmera



Palmera

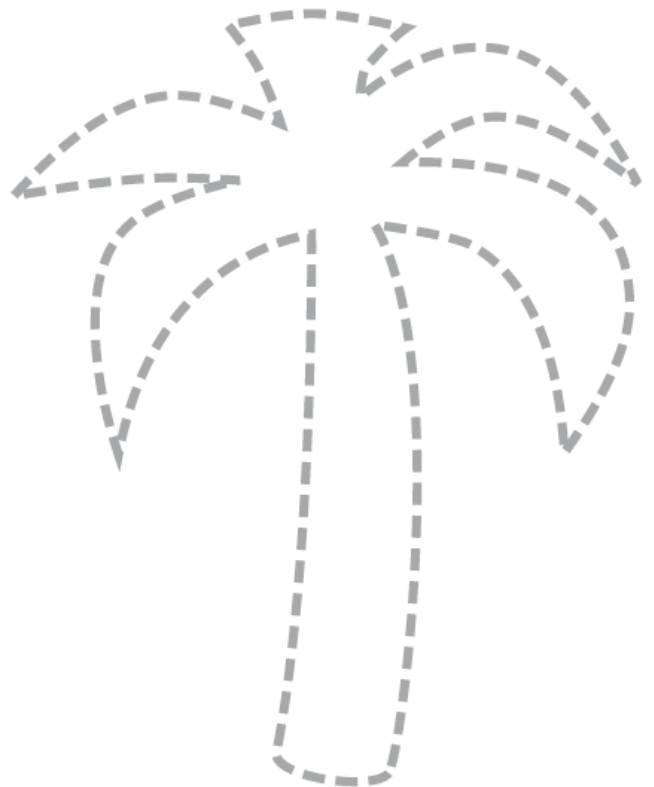
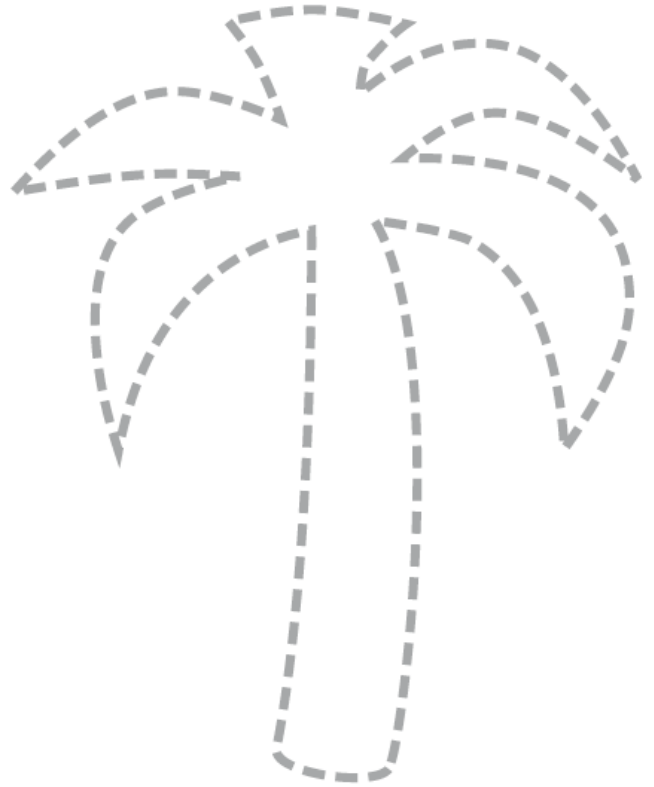

Lazo

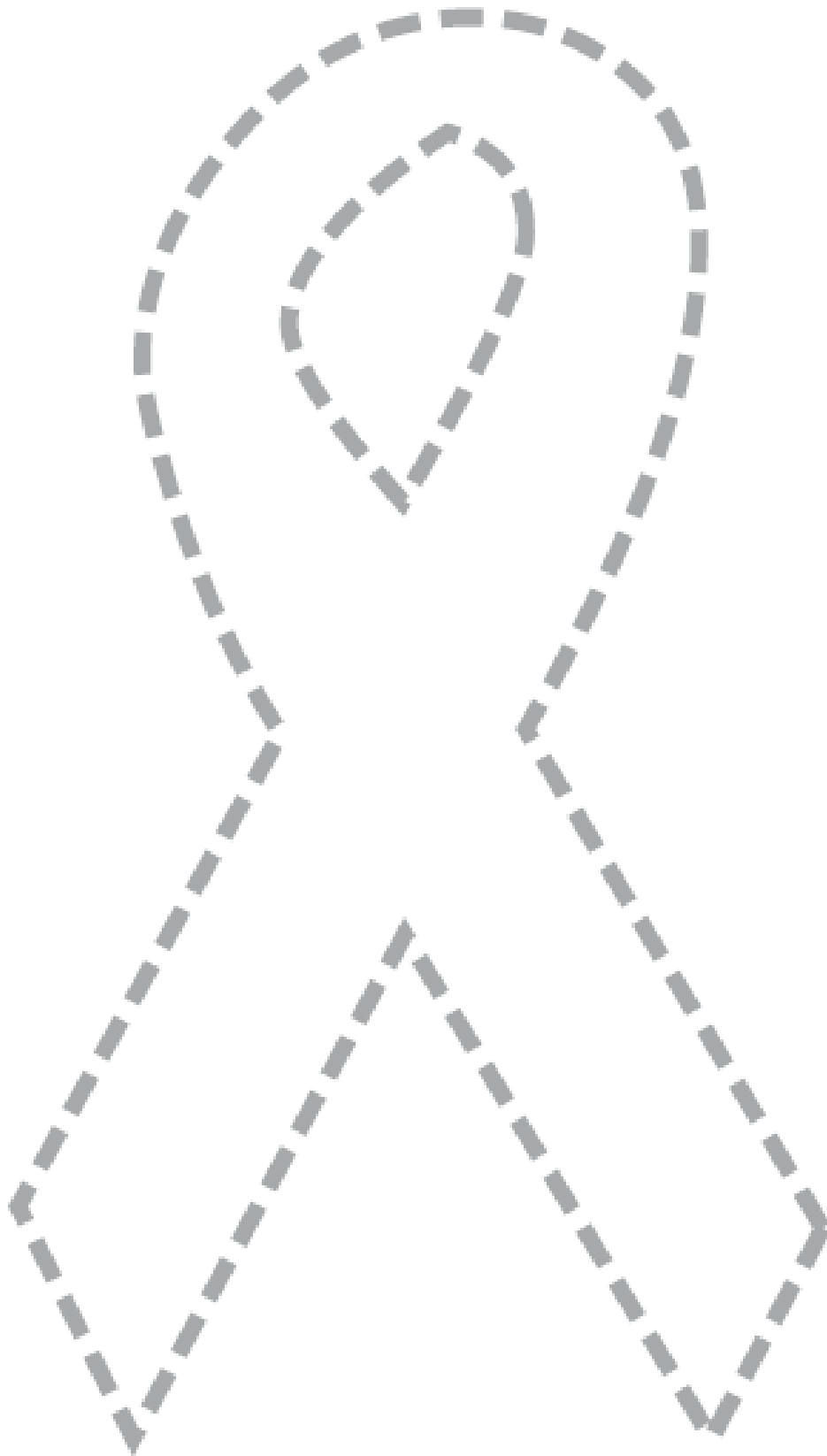

Lazo

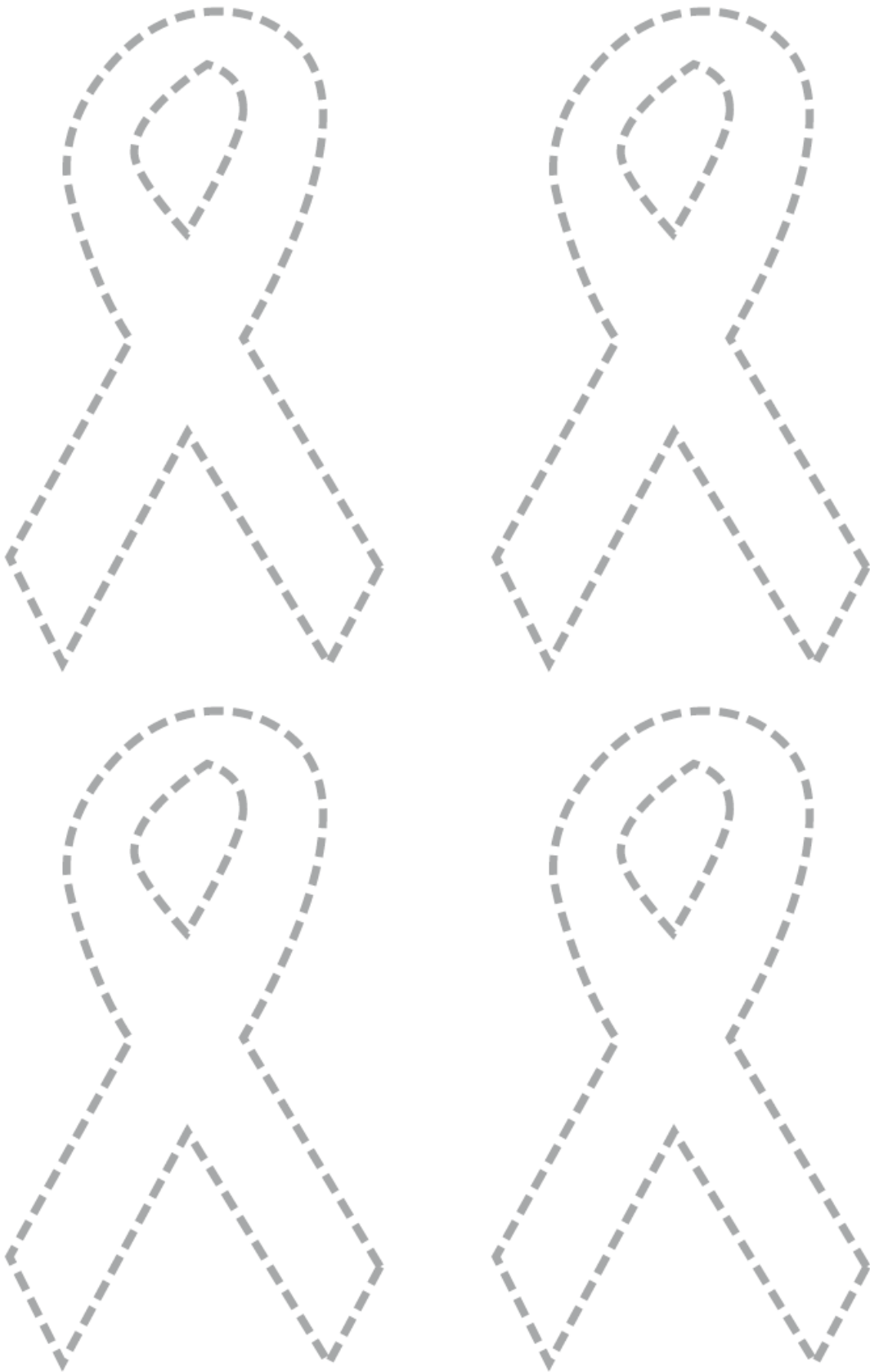

Flechas



Flechas

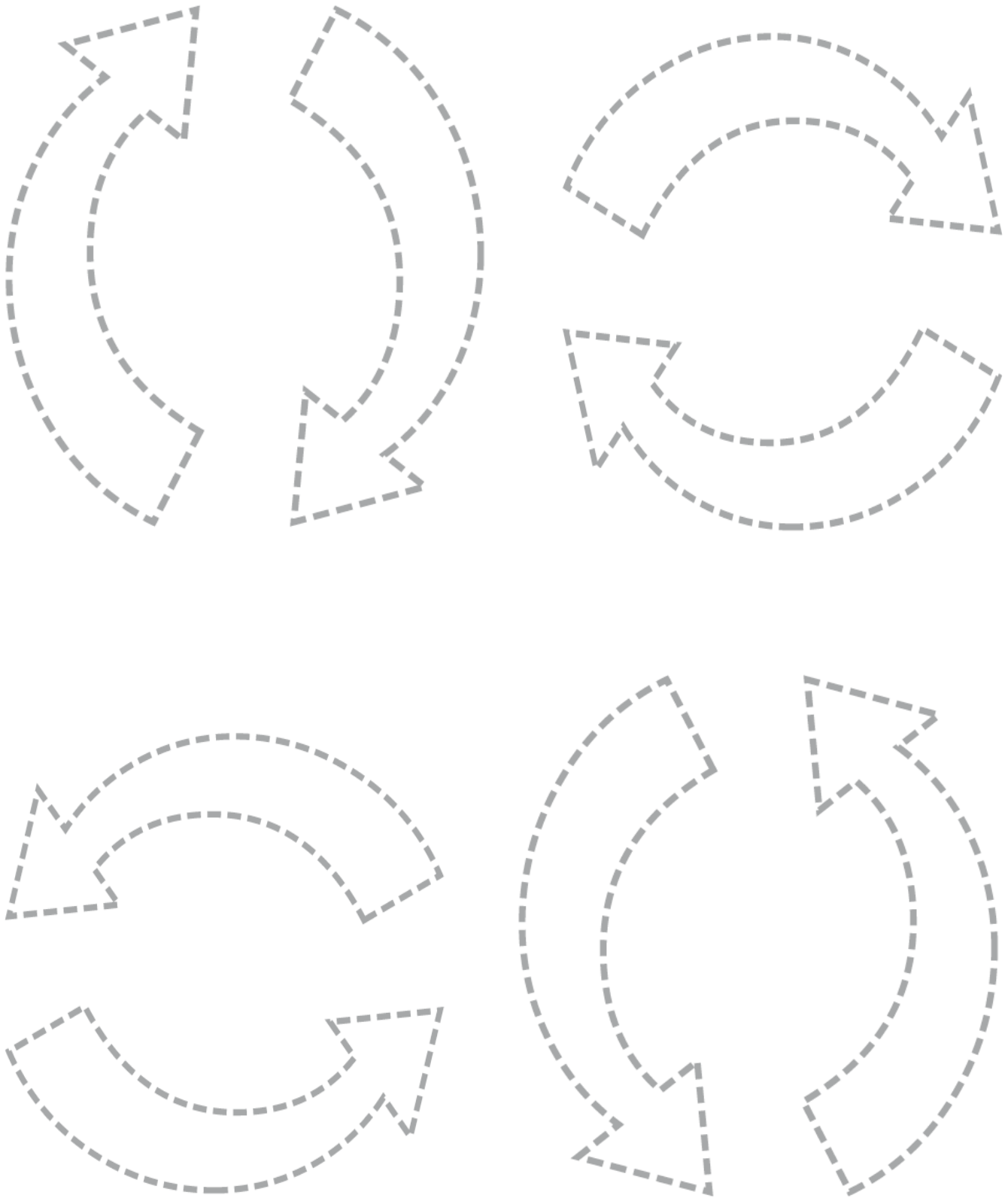

Llave inglesa

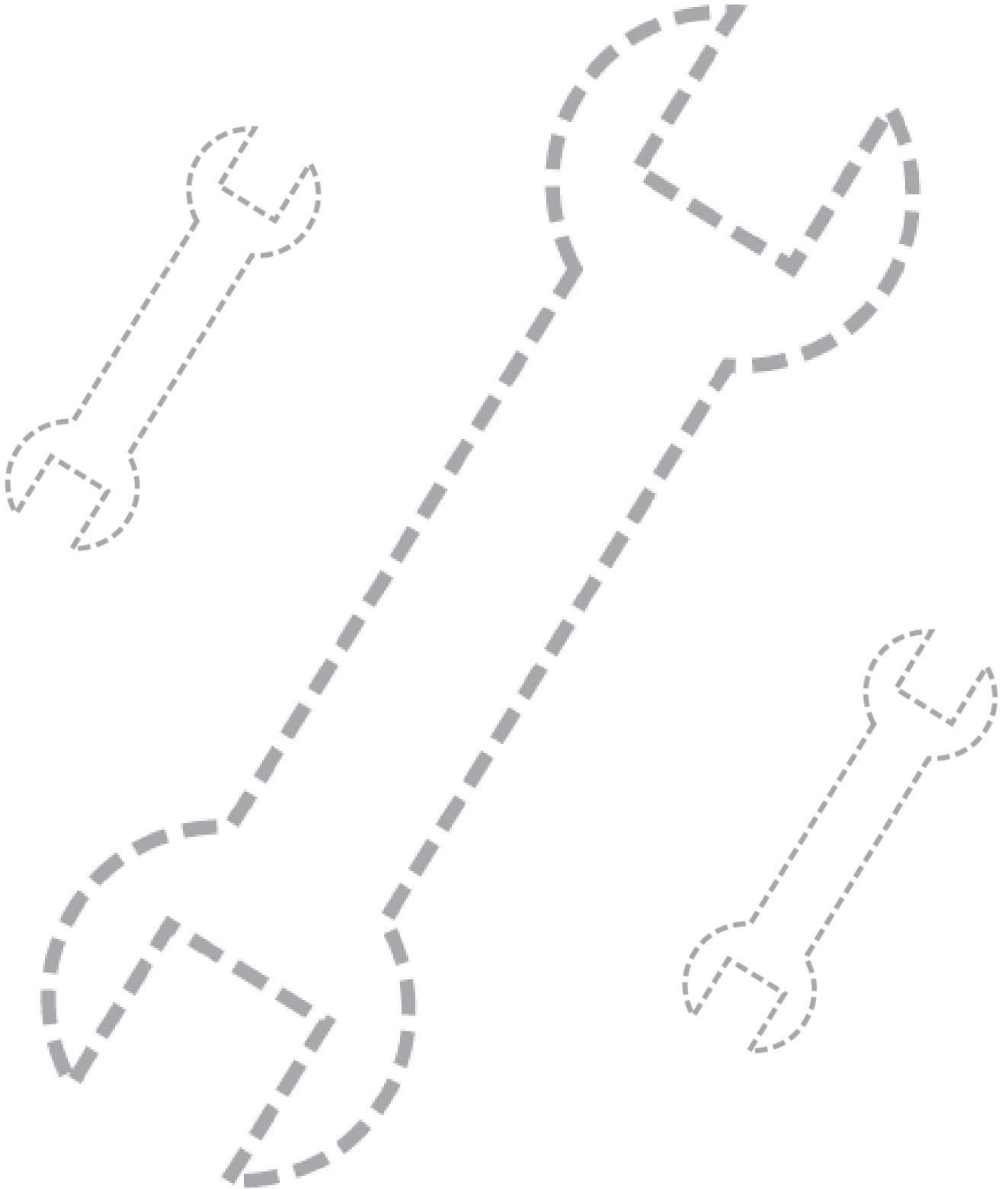

Llave inglesa



Bomba

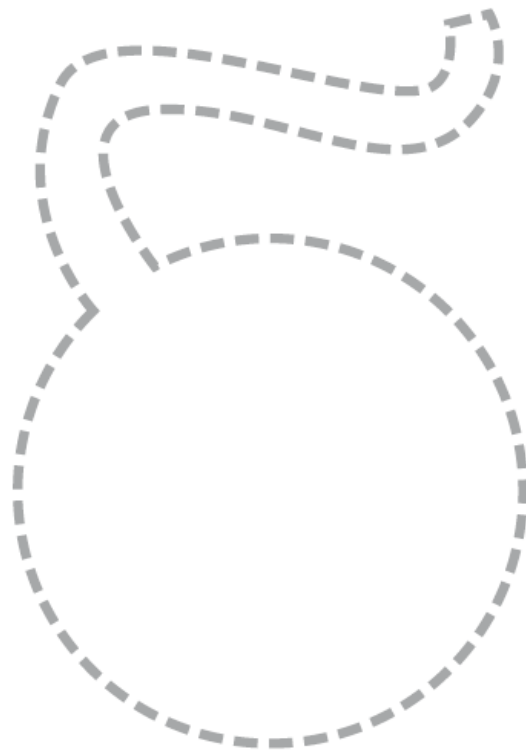
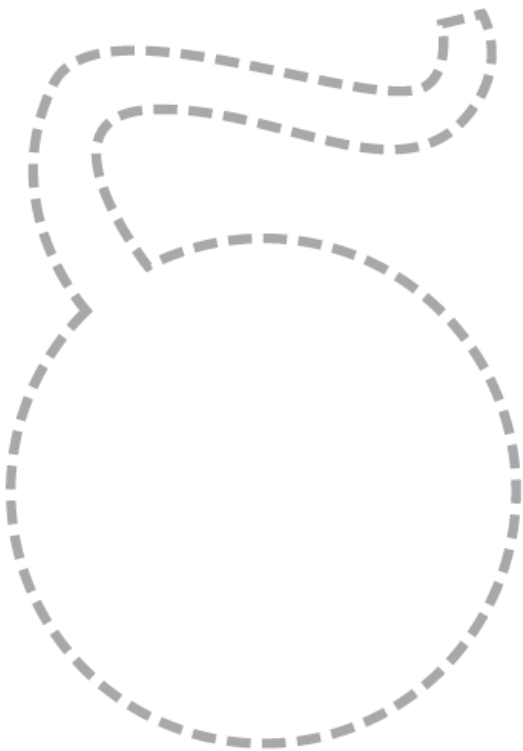
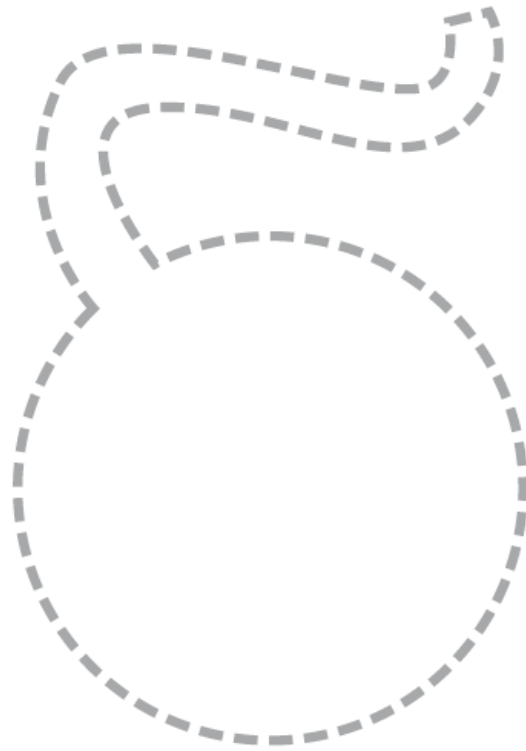
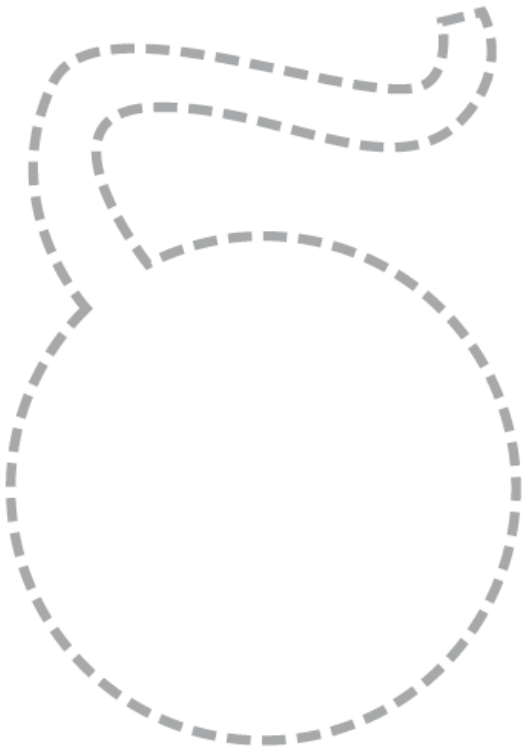

Aspa



Aspa



Espiral

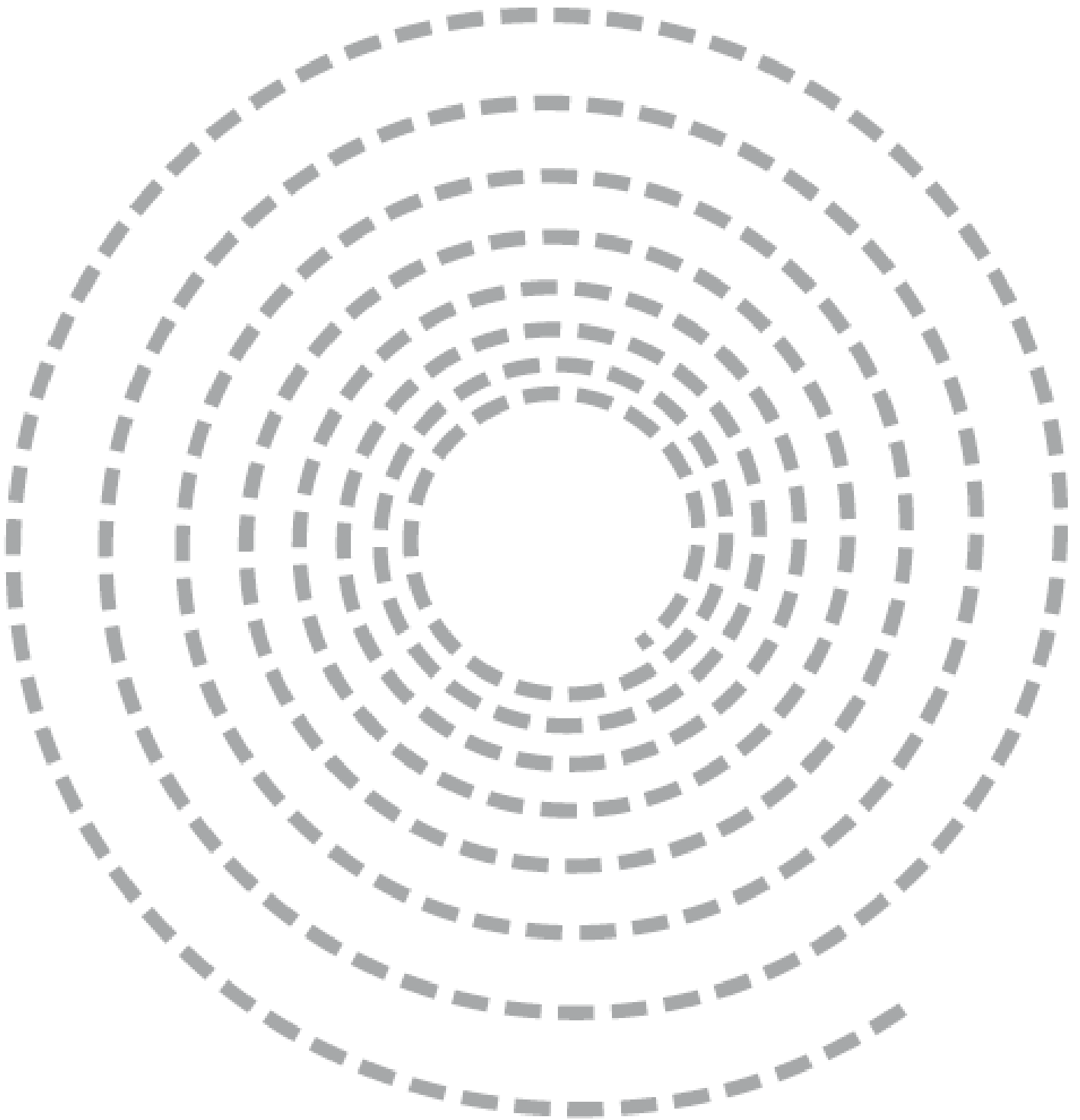

Espiral

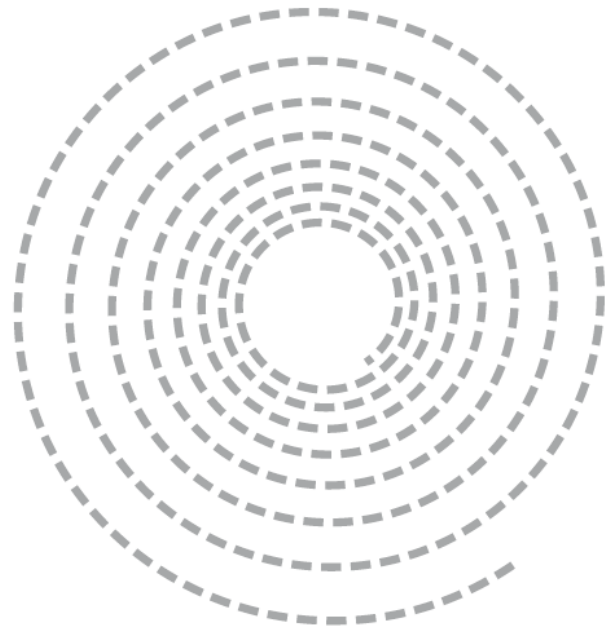
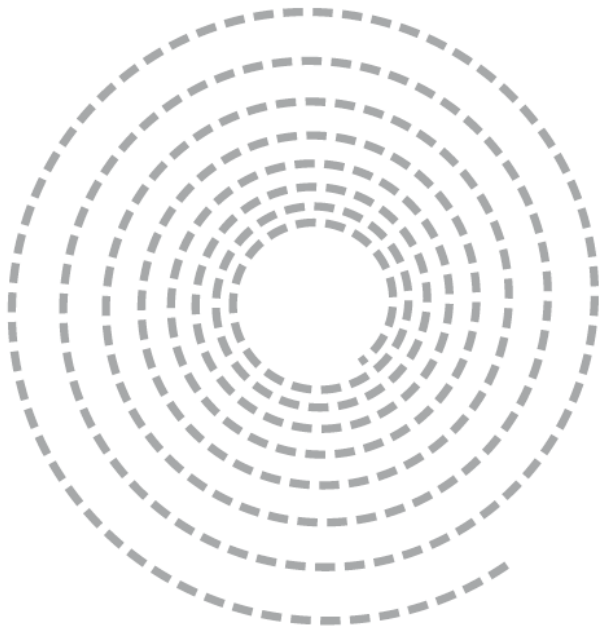
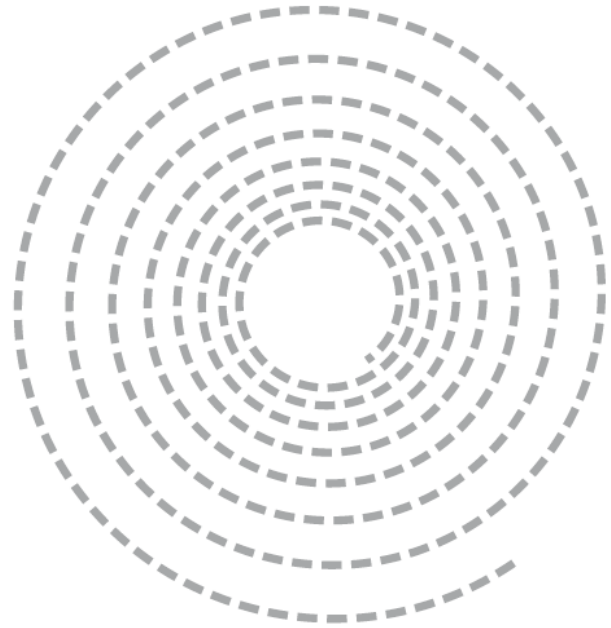
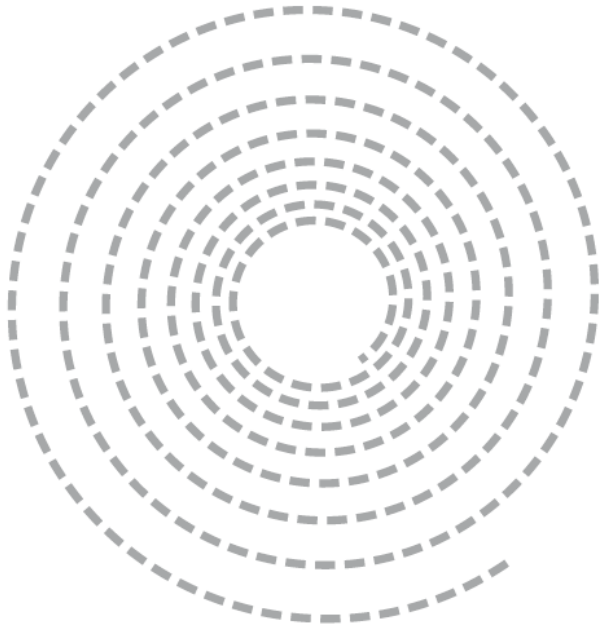

Luna

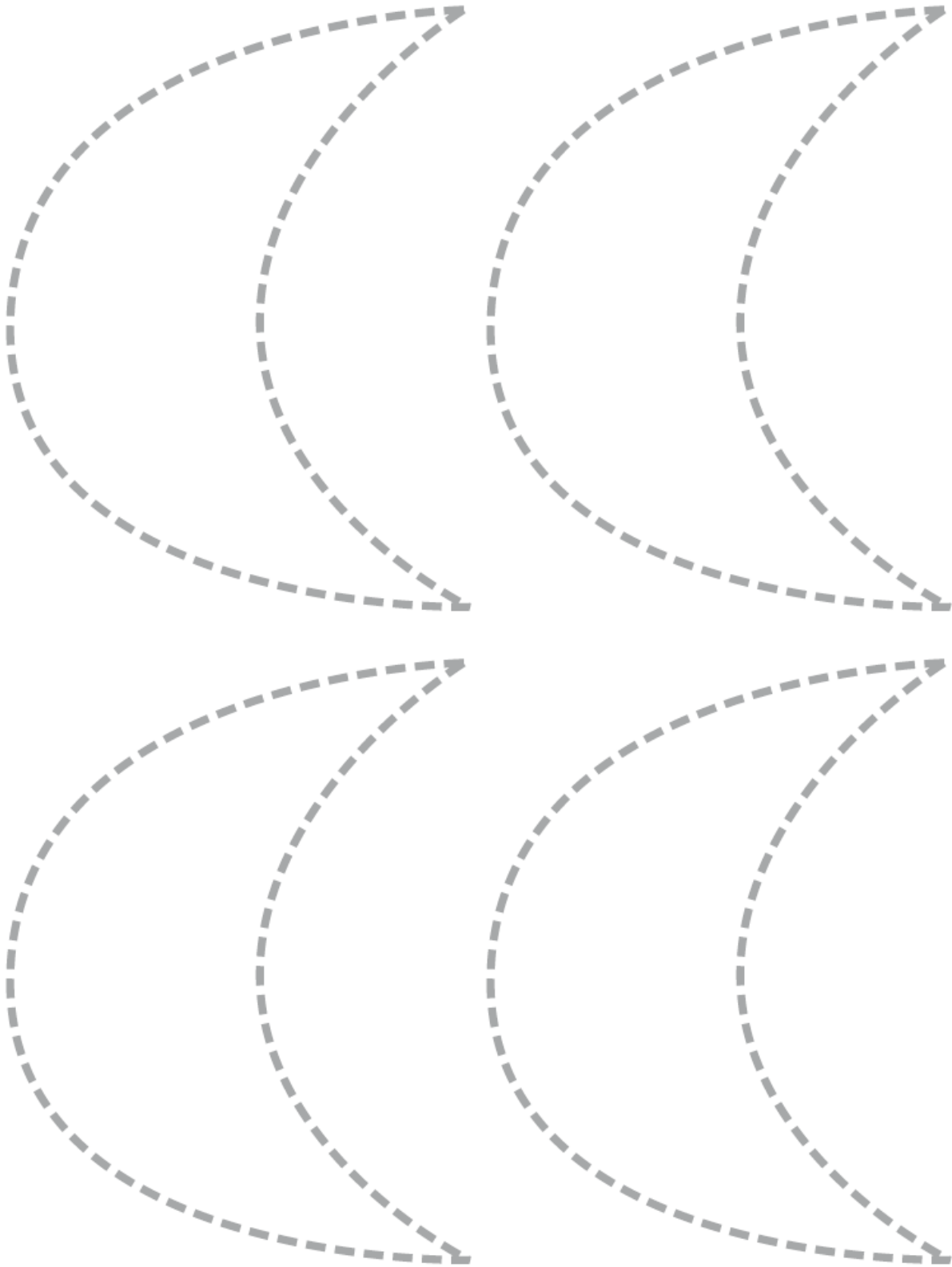

Luna

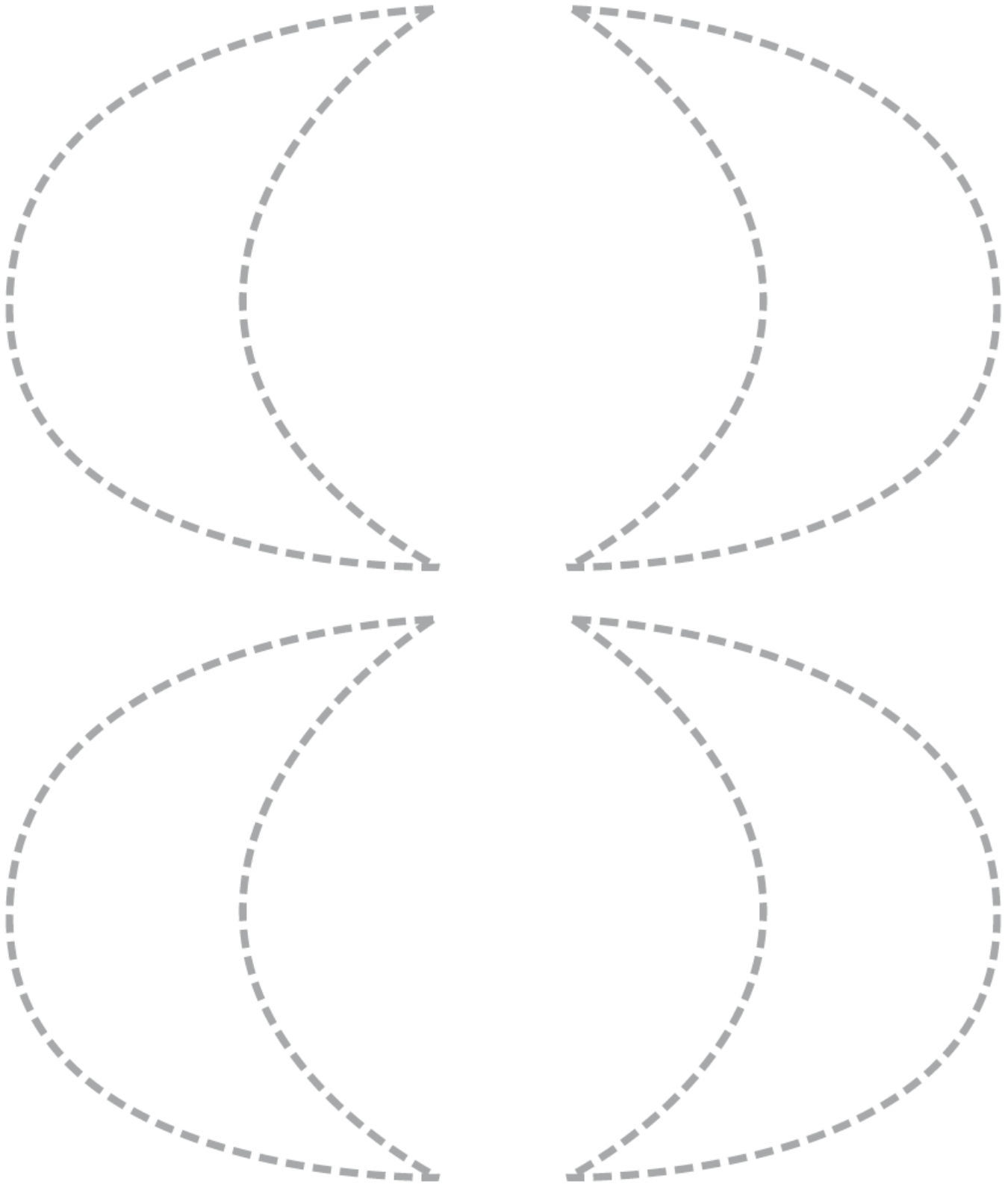

Flecha



Flecha

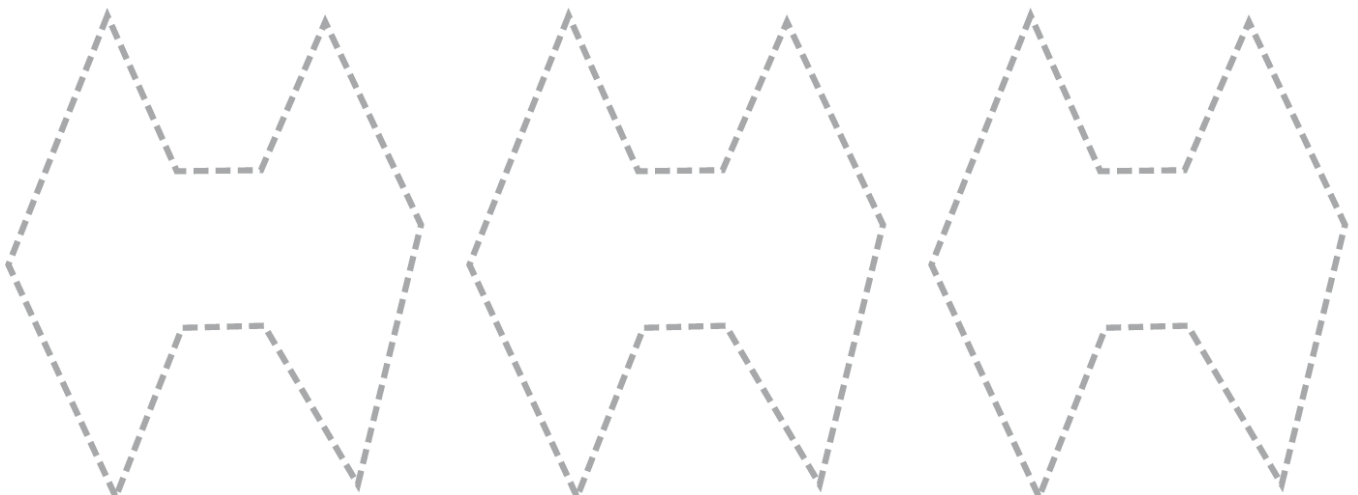
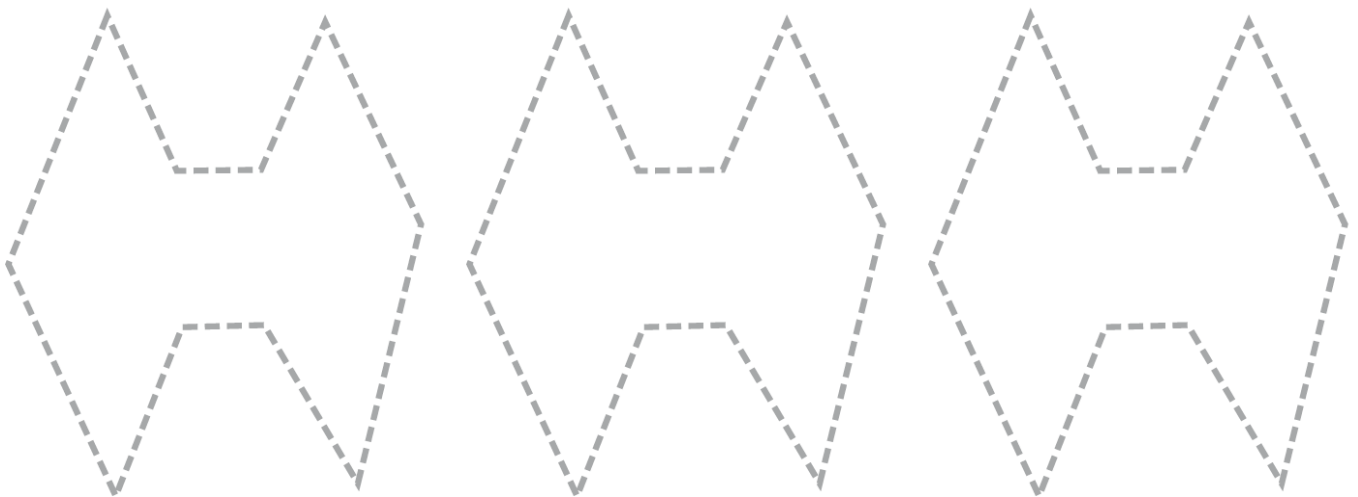
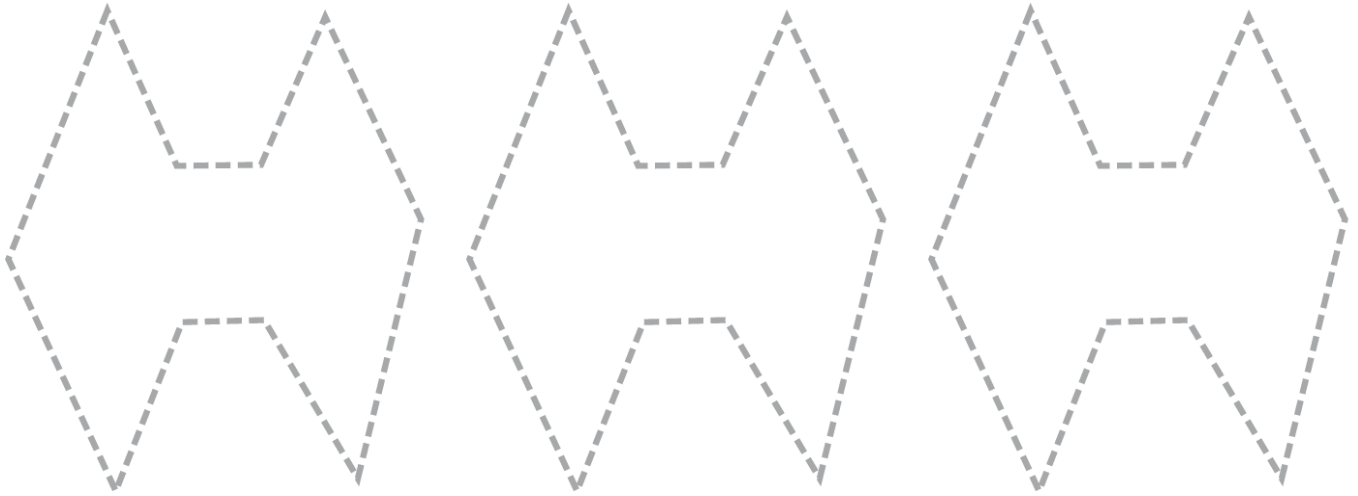

GRAFOMOTRICIDAD

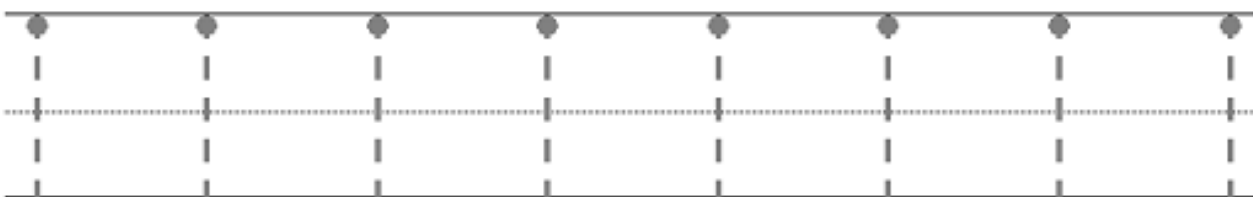
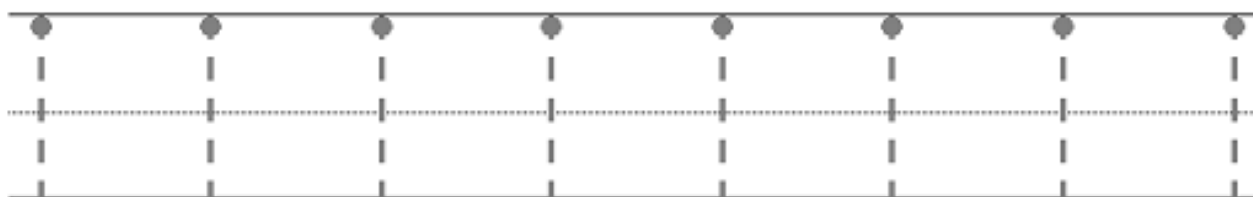
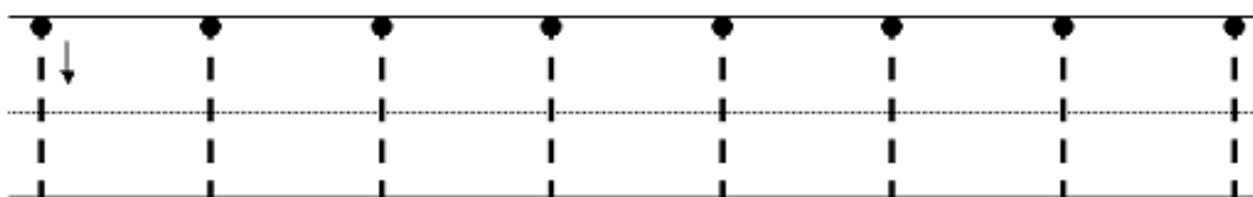
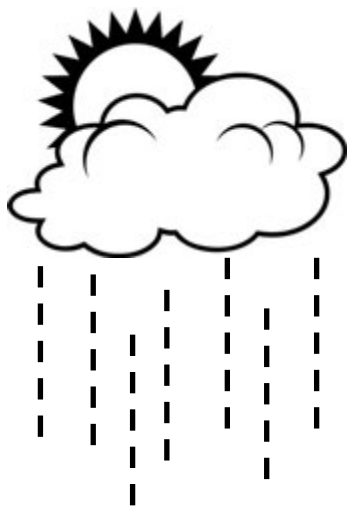

GRAFOMOTRICIDAD

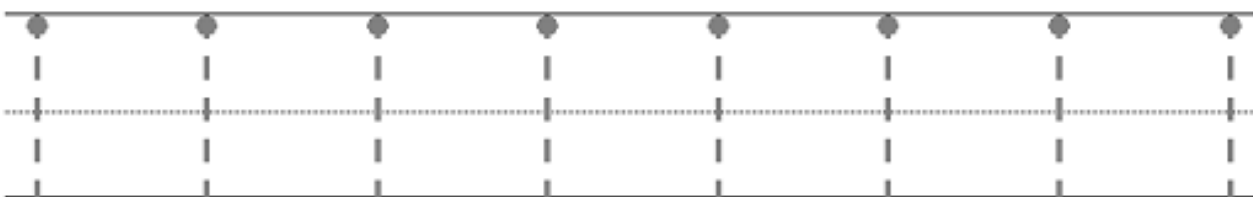
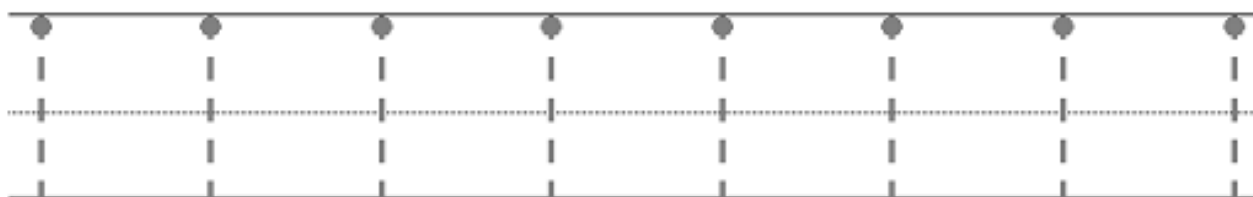
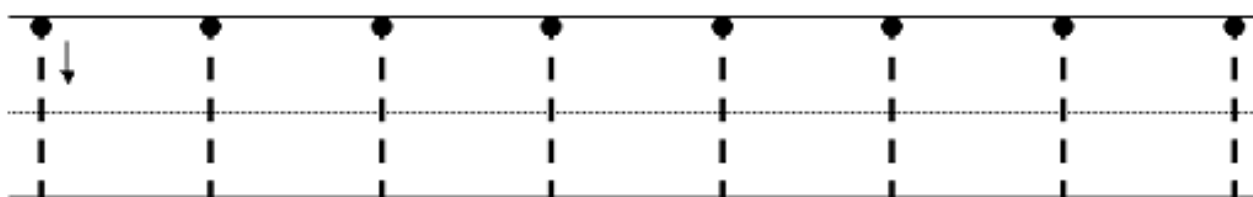

GRAFOMOTRICIDAD

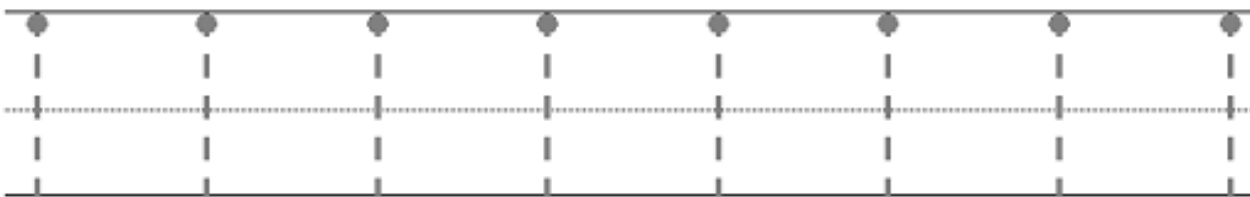
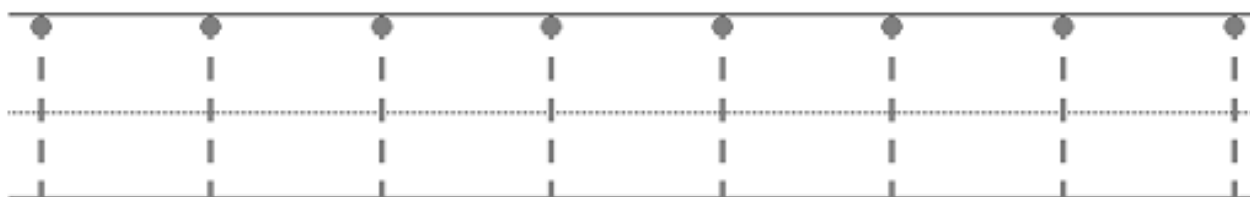
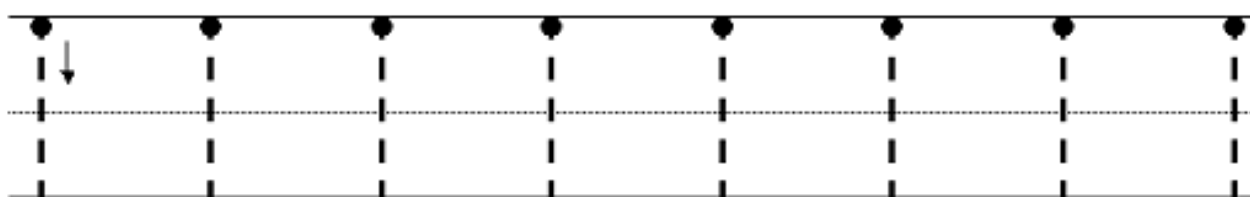
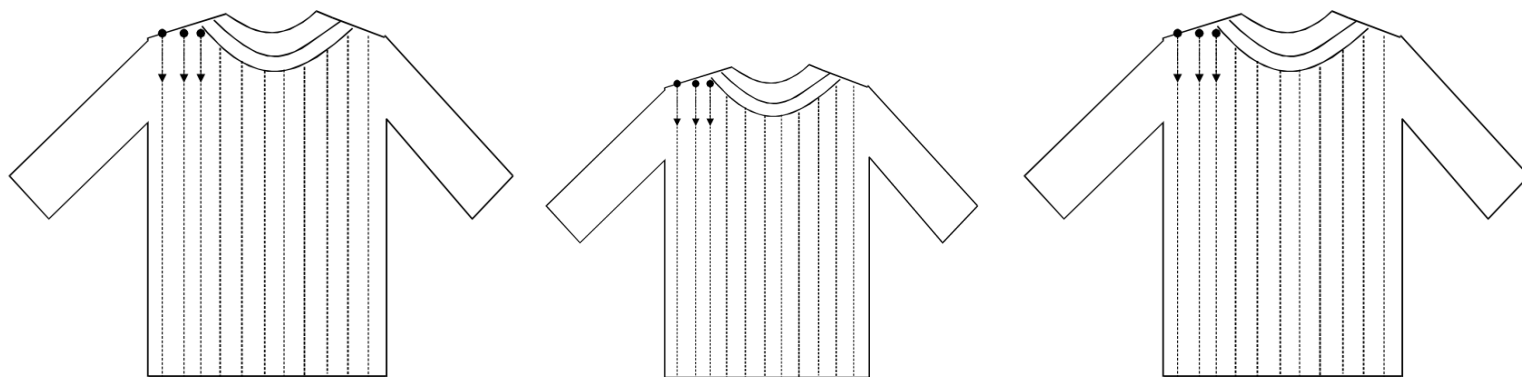

GRAFOMOTRICIDAD

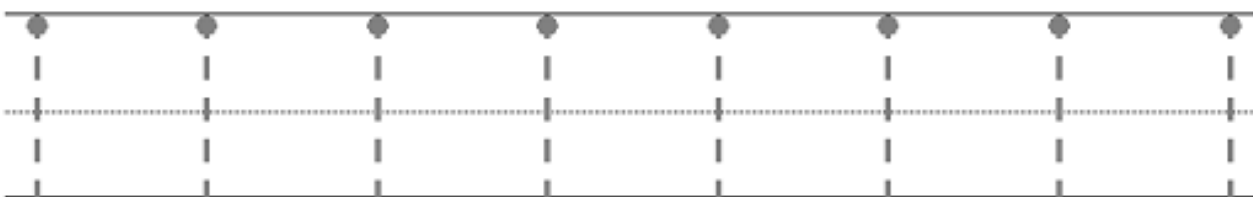
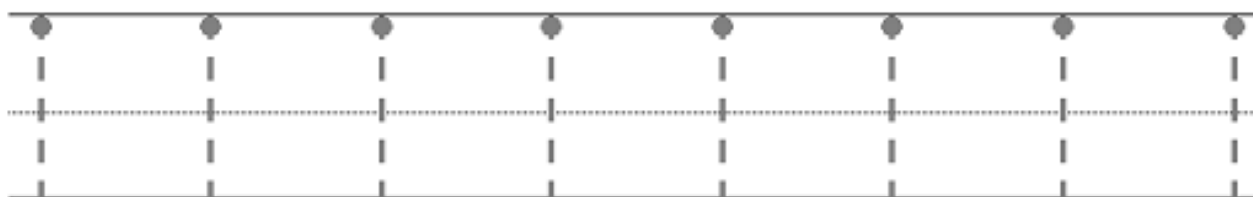
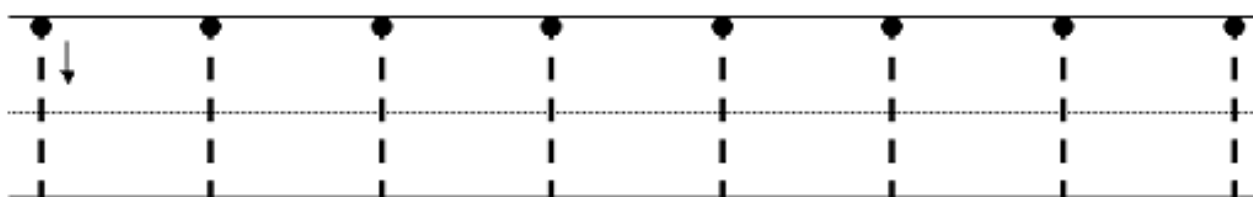
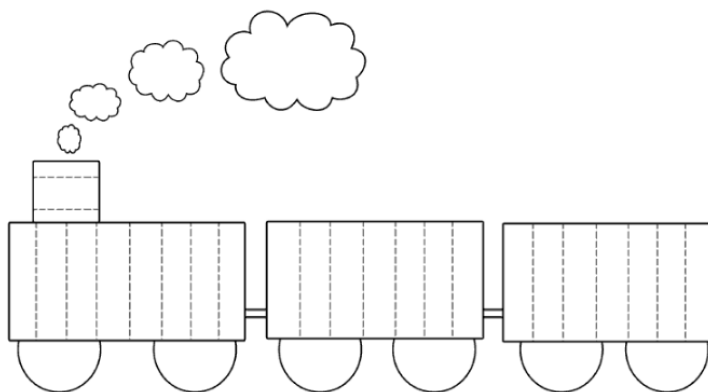

GRAFOMOTRICIDAD

The image shows a handwriting practice sheet for the letter 'A'. At the top, the word 'GRAFOMOTRICIDAD' is written in large, bold, red capital letters. Below the title, there are seven columns. Each column contains a small illustration of a moon at the top, a dashed vertical line with an upward-pointing arrow in the middle, and a small outline of the letter 'A' at the bottom. Below these columns are five rows of handwriting lines. Each row consists of a solid top line, a dashed middle line, and a solid bottom line. The first row has a small downward-pointing arrow on the left side of the top line. The second row has eight black dots on the top line, one in each column. The third, fourth, and fifth rows have three black dots on the top line, one in each of the first three columns.



GRAFOMOTRICIDAD

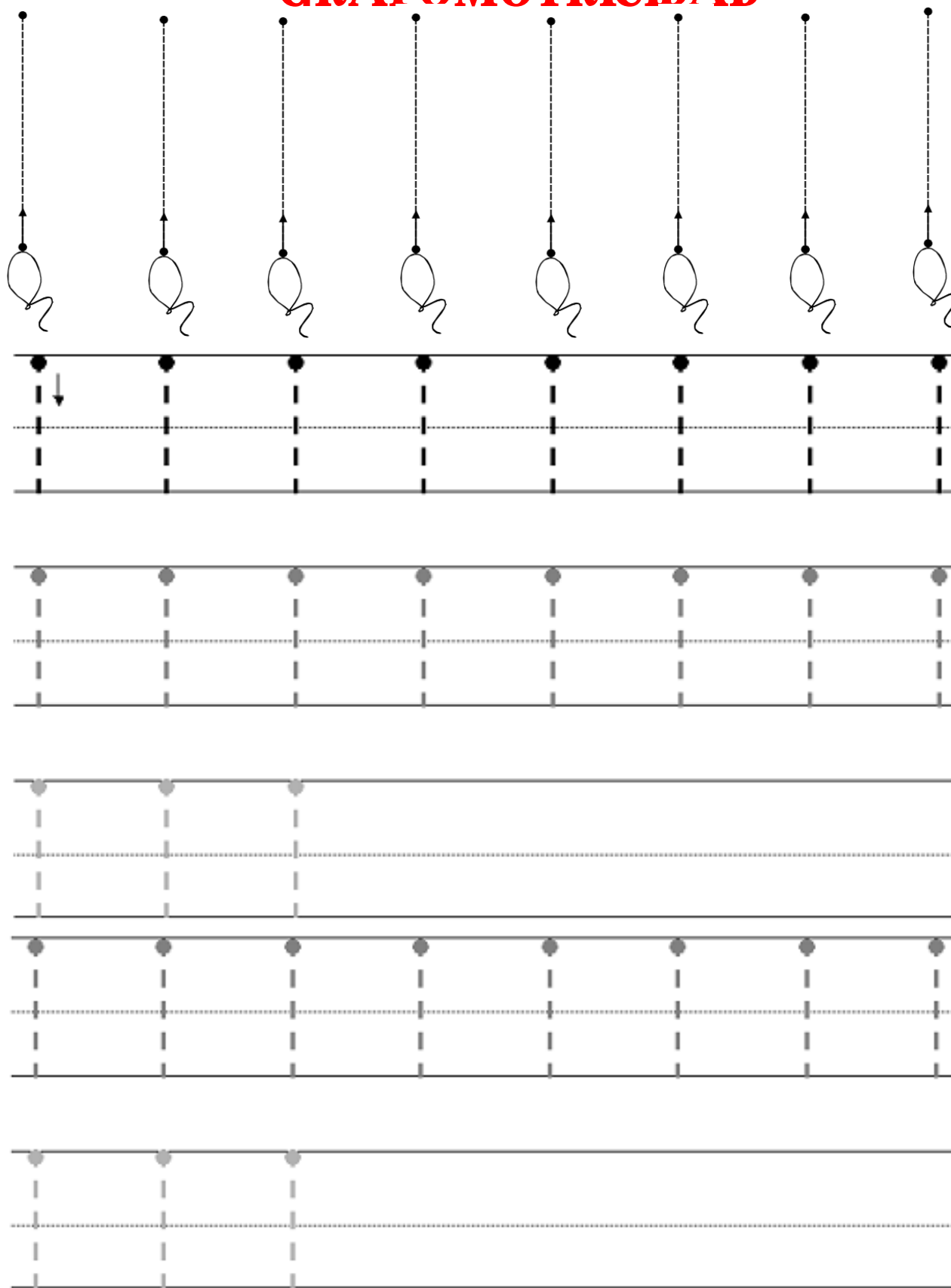

GRAFOMOTRICIDAD

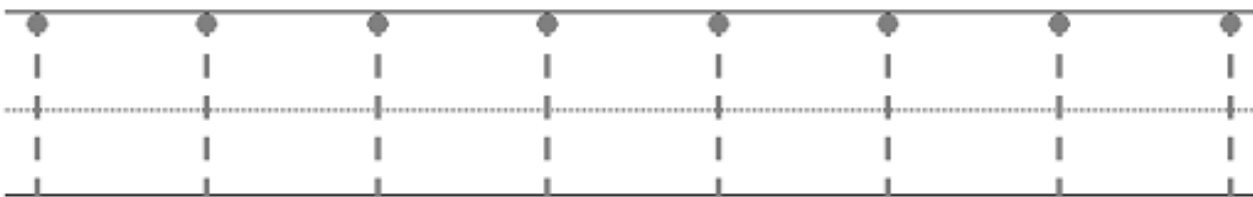
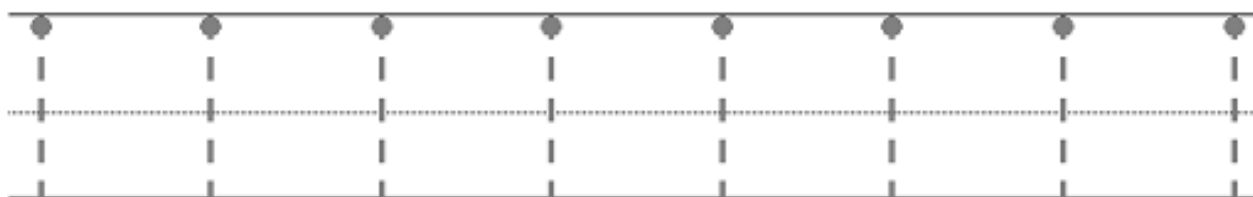
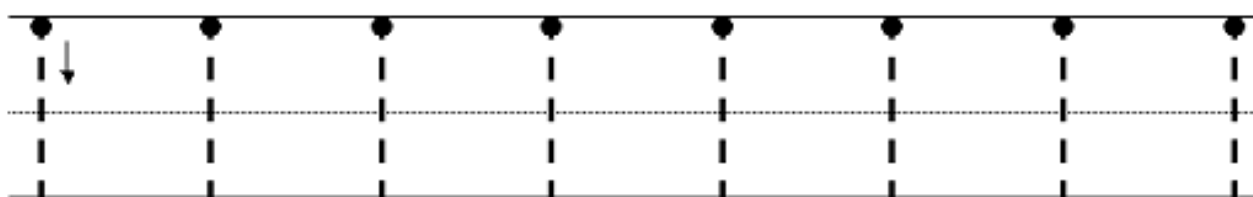
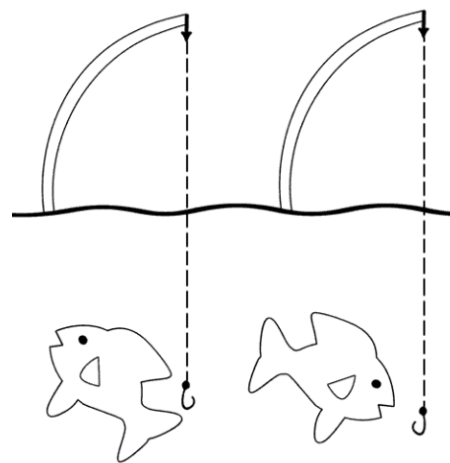
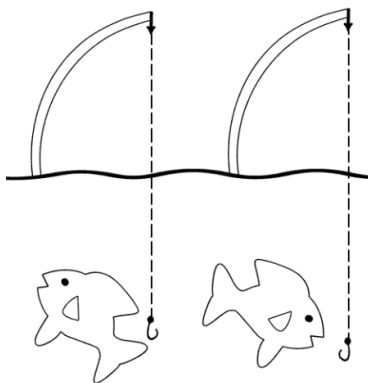
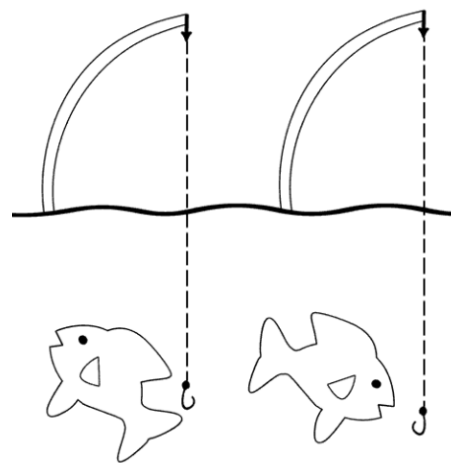

GRAFOMOTRICIDAD

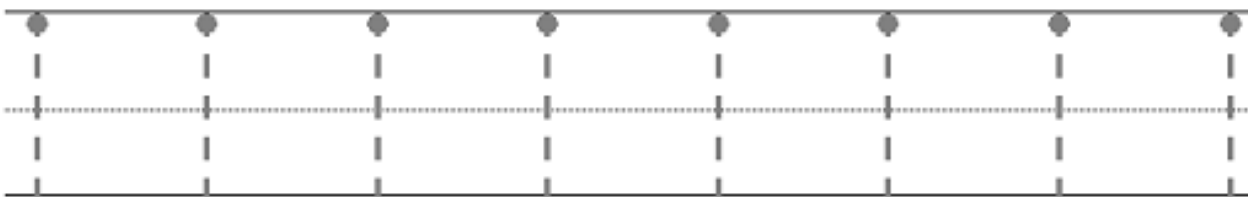
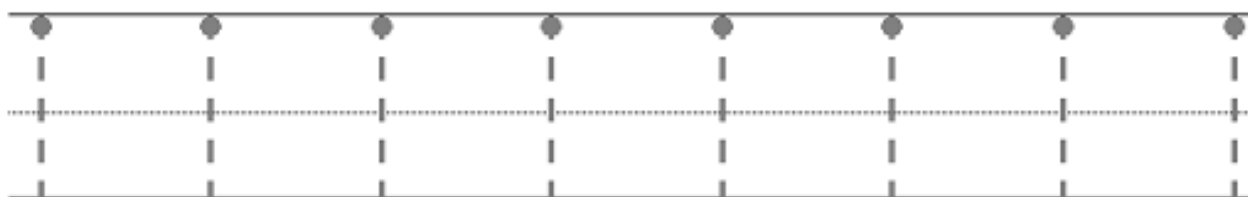
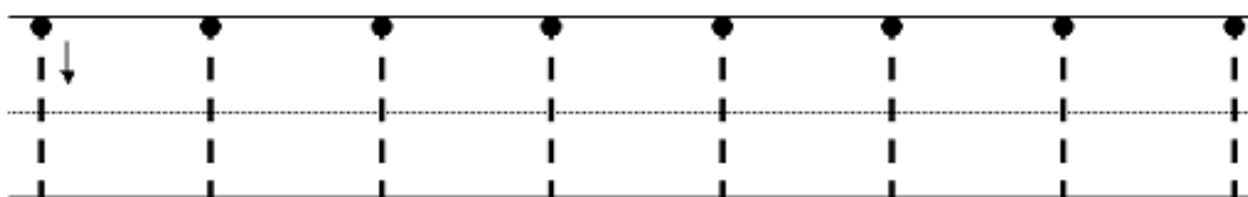

Más material en



<https://orientacionandujar.wordpress.com/>

GRAFOMOTRICIDAD

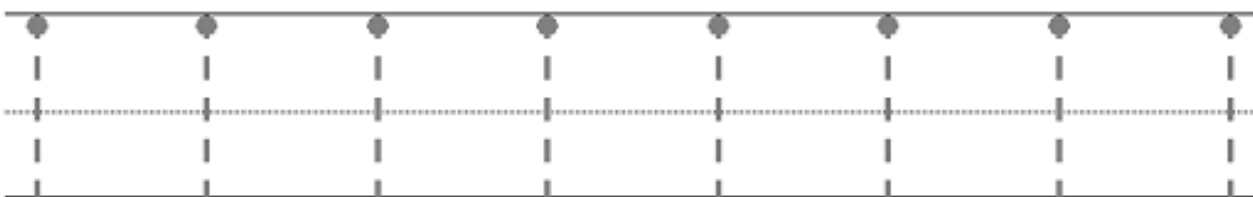
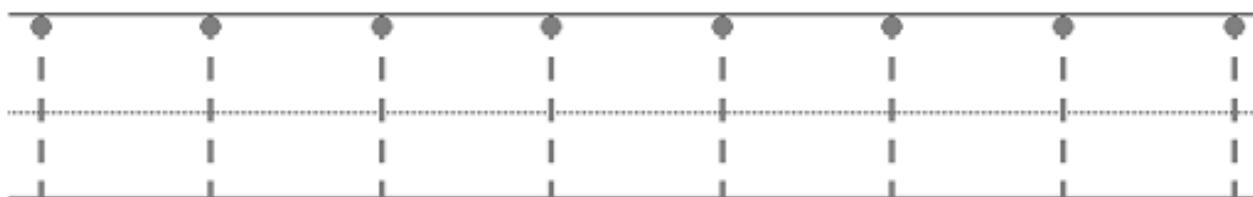
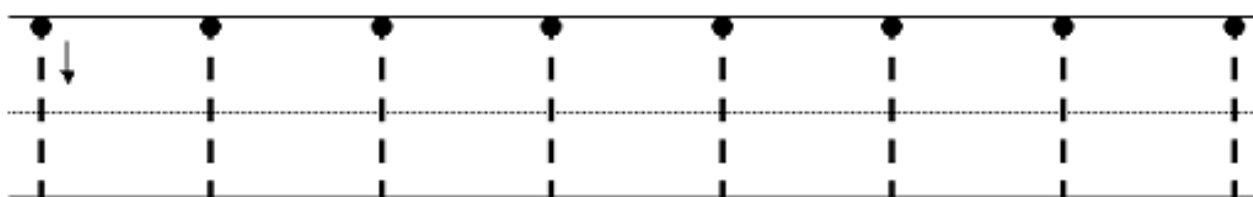
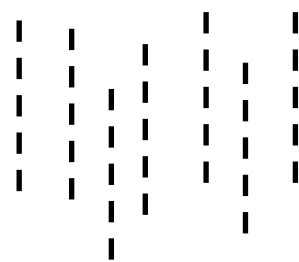
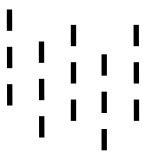
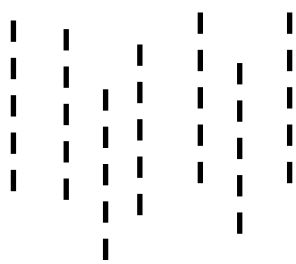

GRAFOMOTRICIDAD

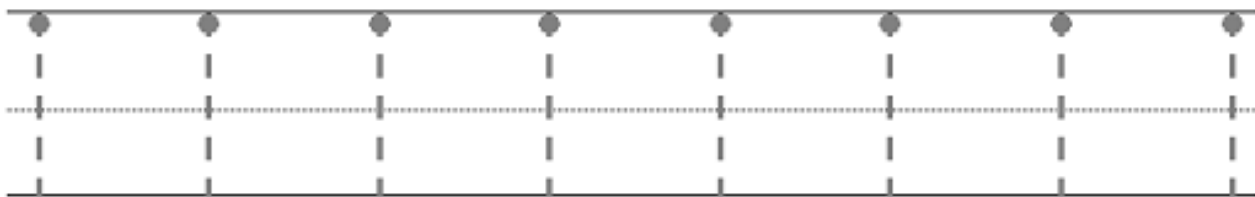
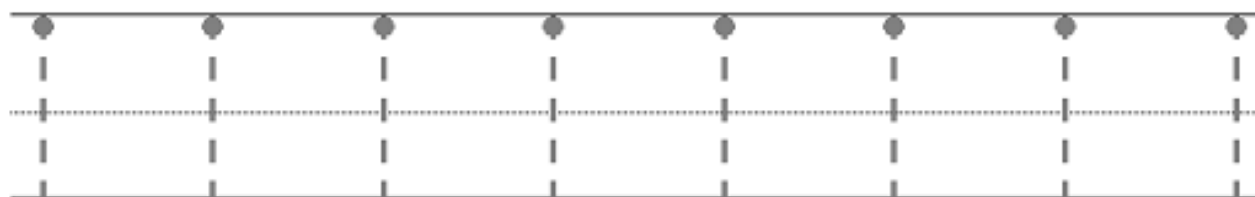
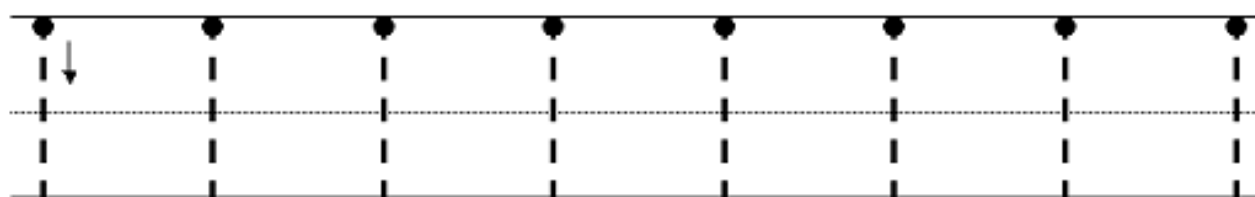

GRAFOMOTRICIDAD

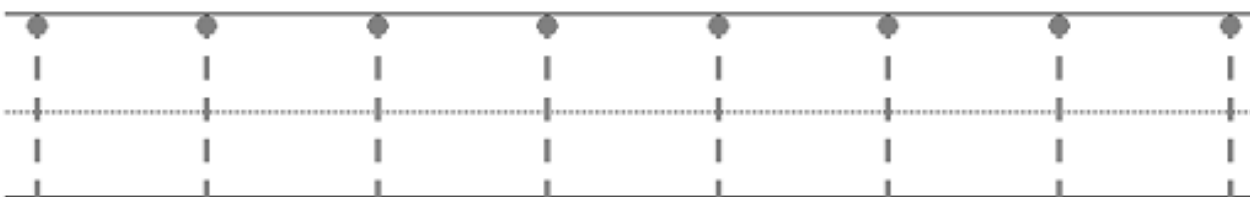
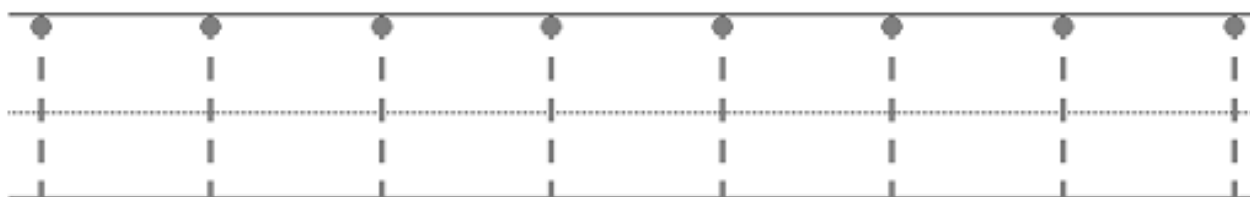
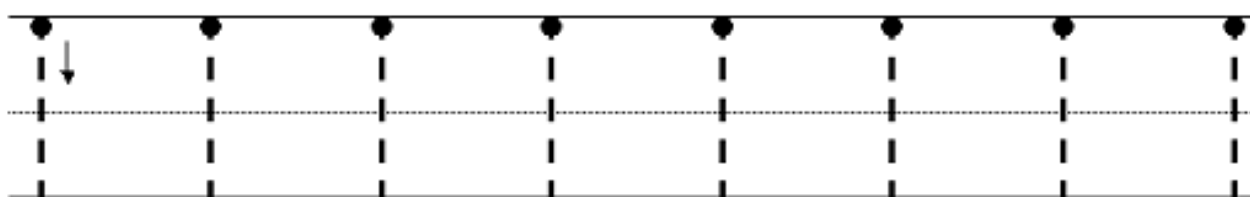
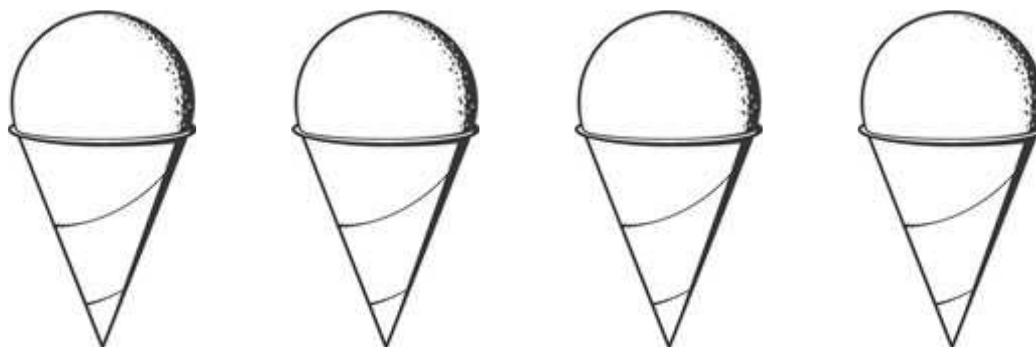

GRAFOMOTRICIDAD

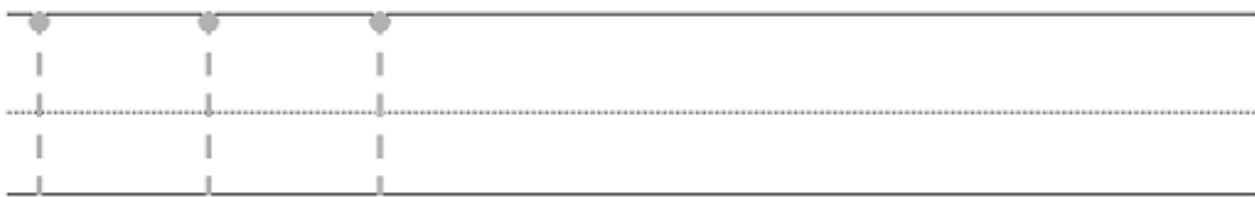
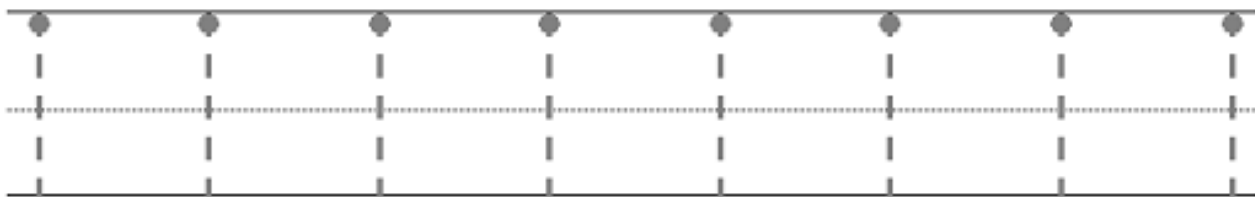
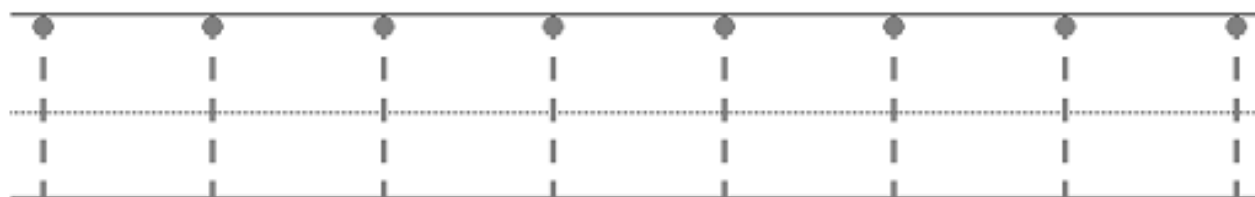
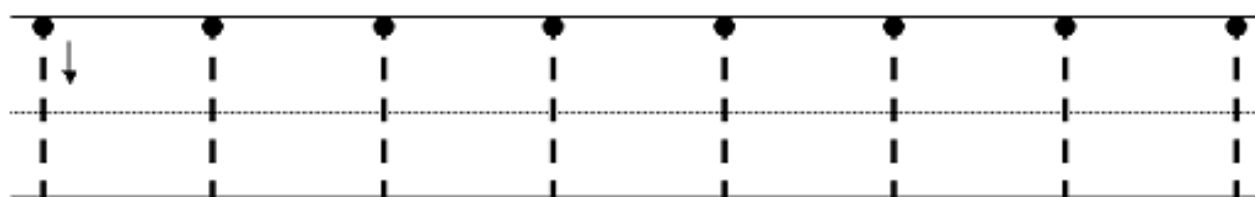
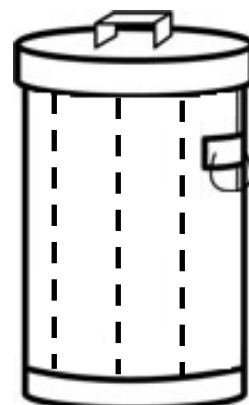
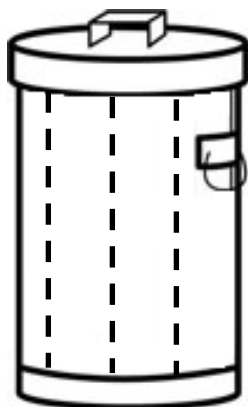
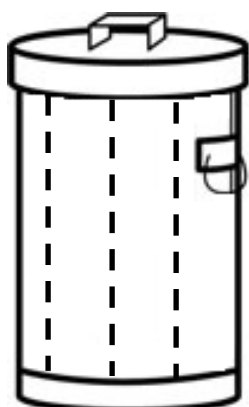

GRAFOMOTRICIDAD

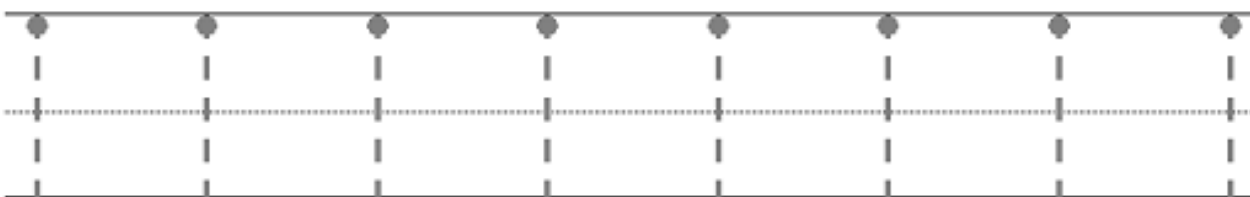
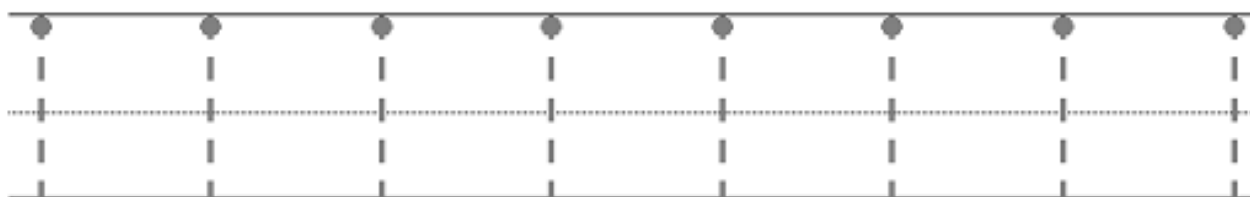
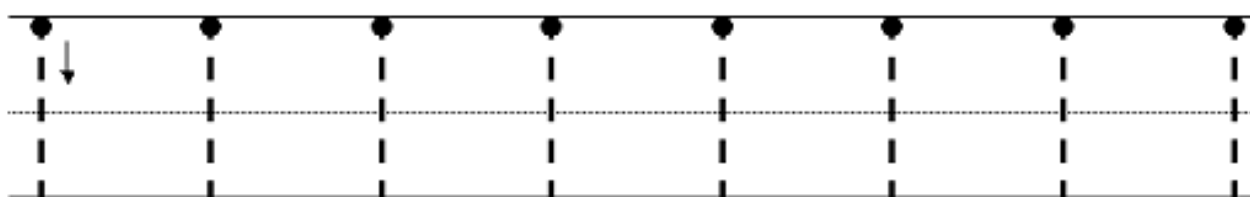
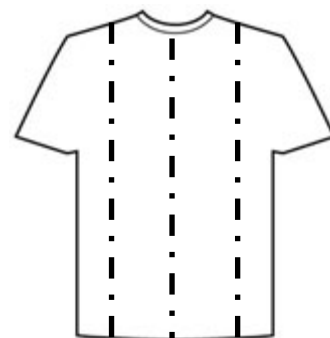
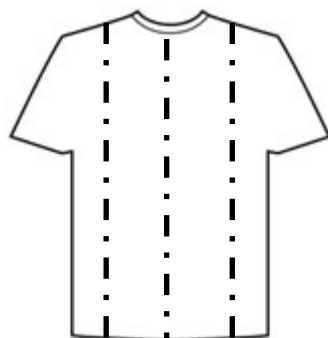
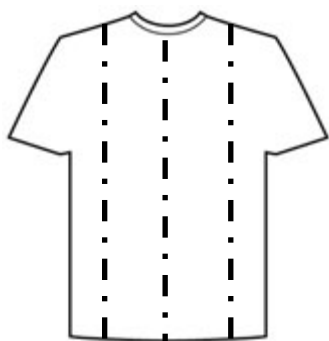

GRAFOMOTRICIDAD

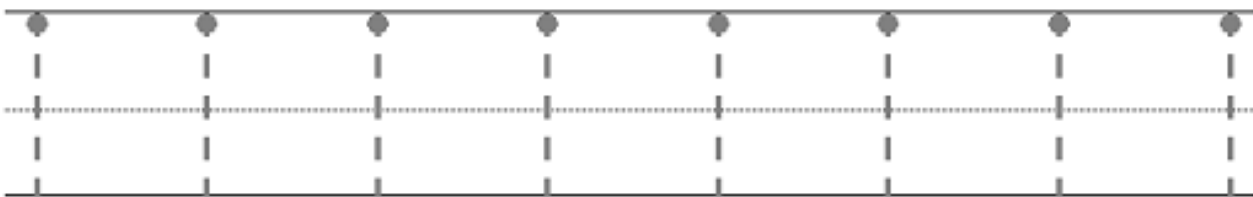
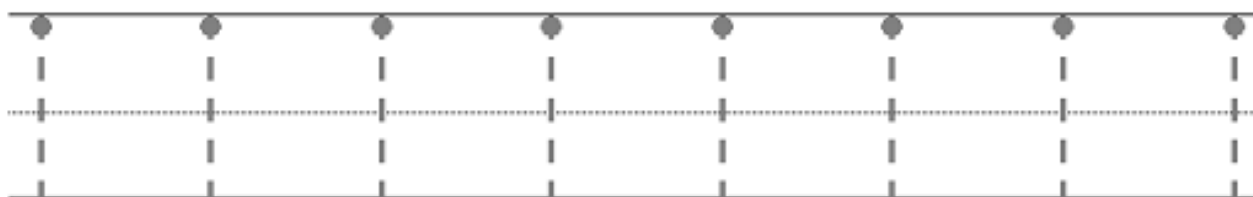
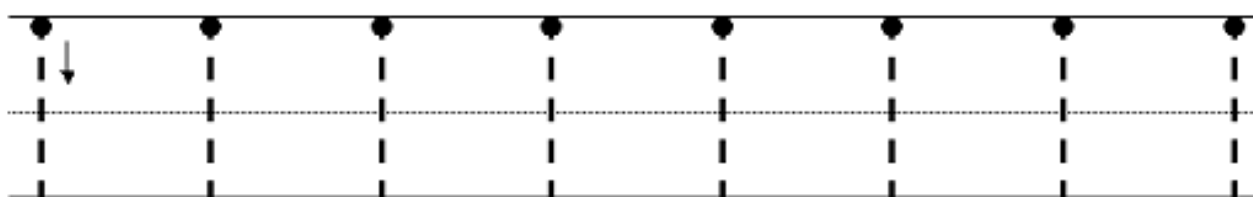
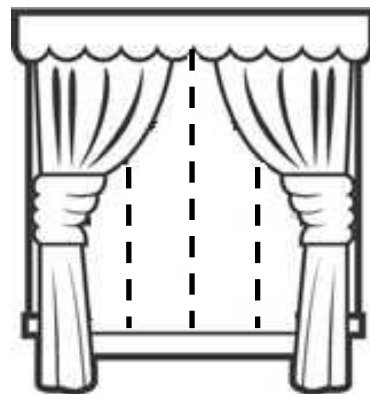
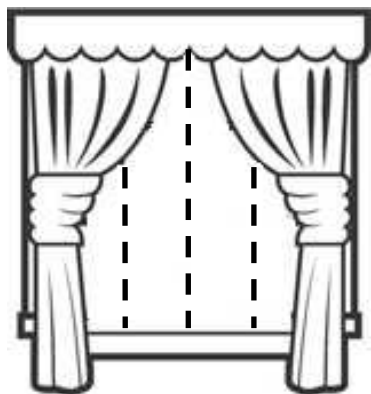

GRAFOMOTRICIDAD

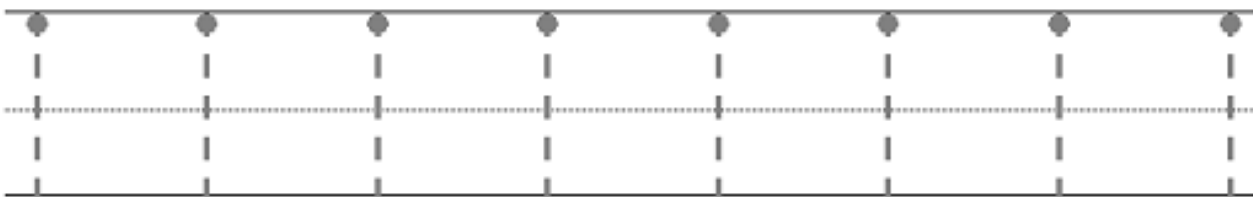
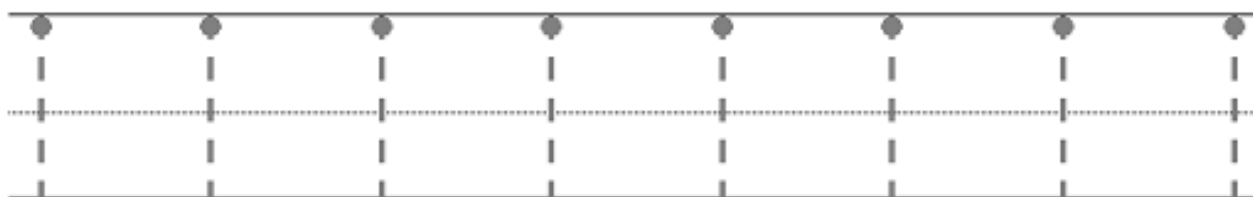
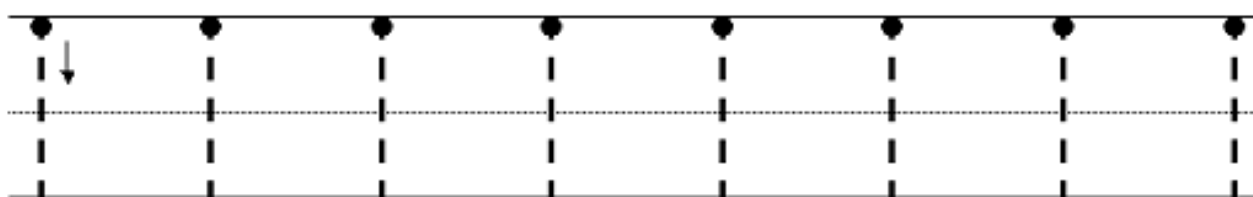
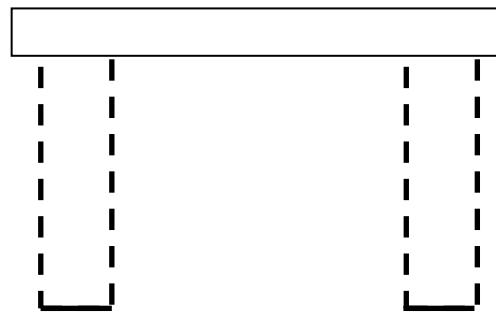
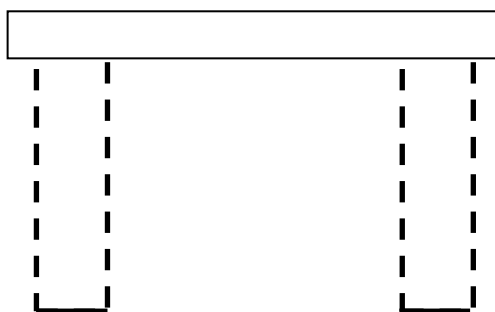

Más material en



<https://orientacionandujar.wordpress.com/>

GRAFOMOTRICIDAD

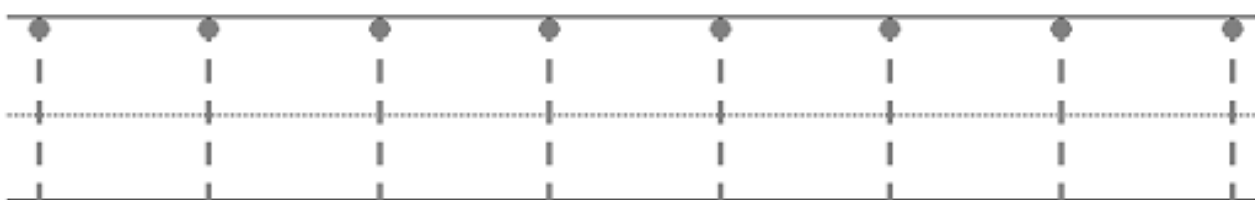
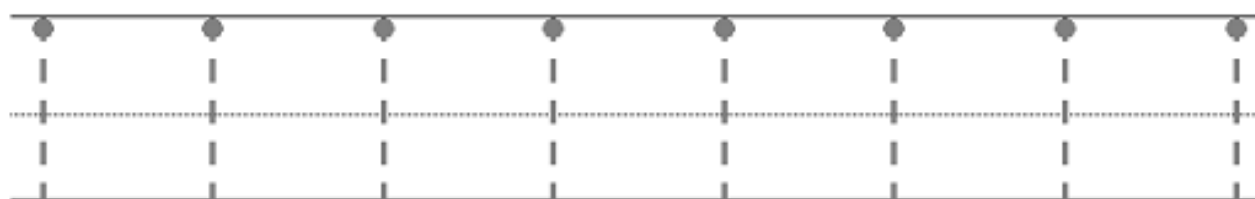
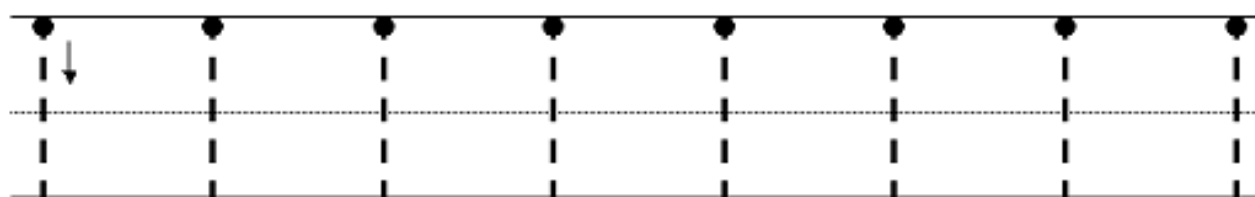
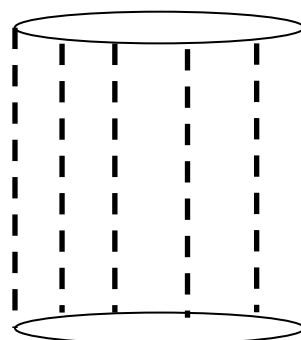
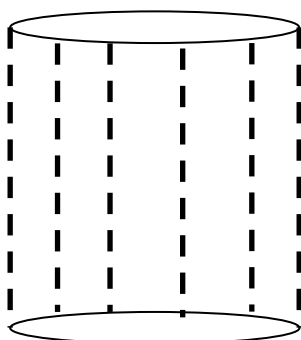
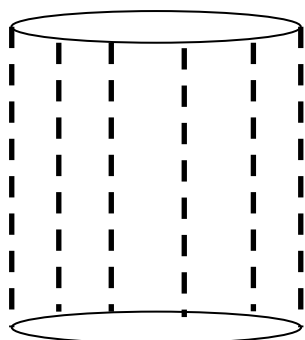

GRAFOMOTRICIDAD

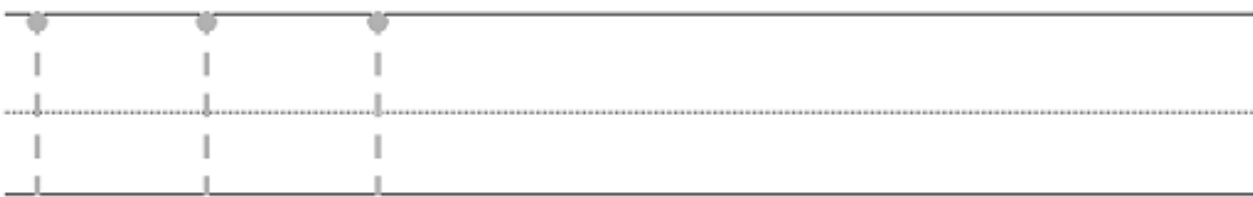
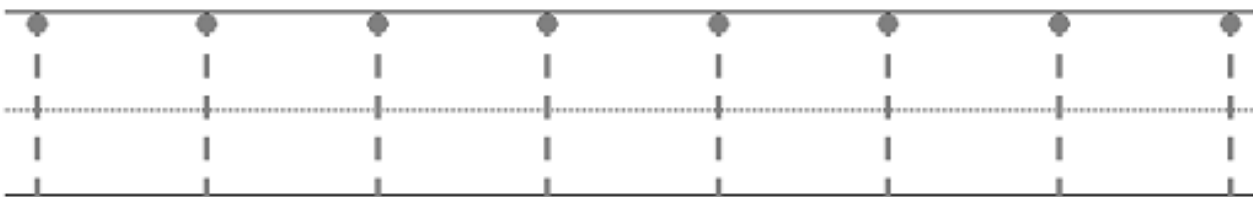
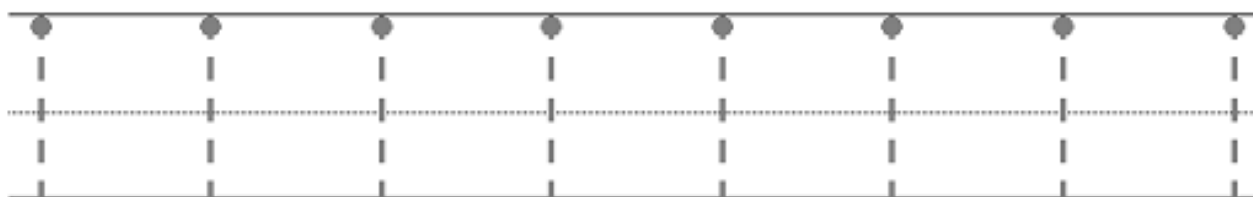
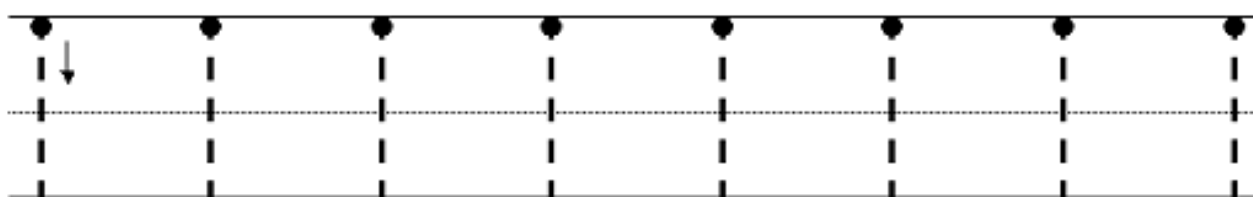

GRAFOMOTRICIDAD

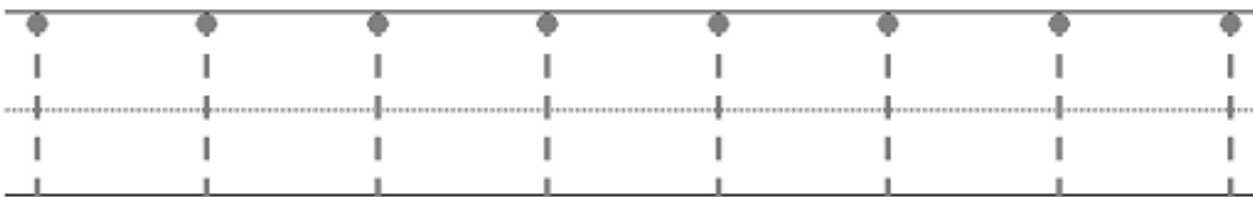
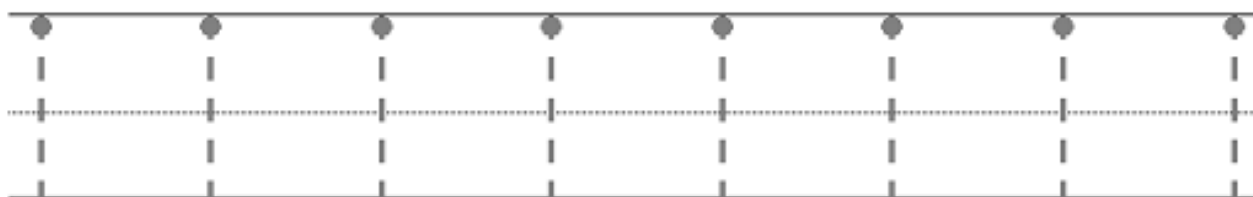
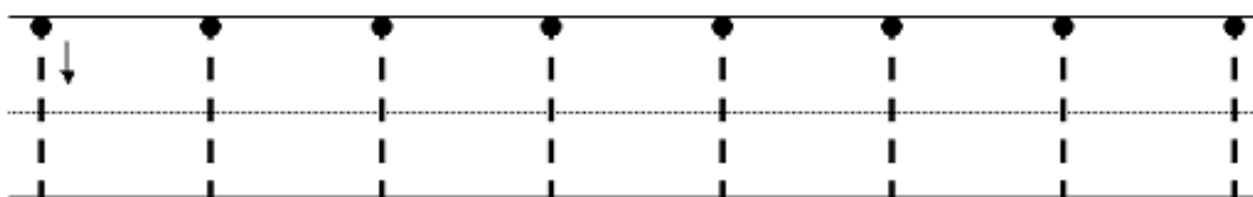
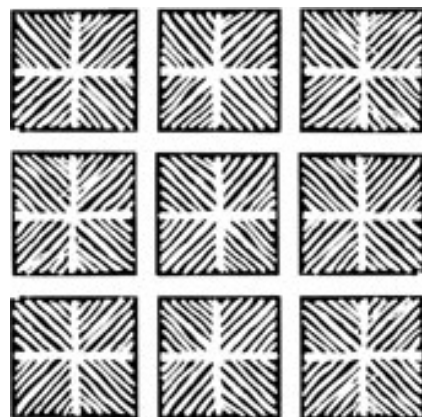
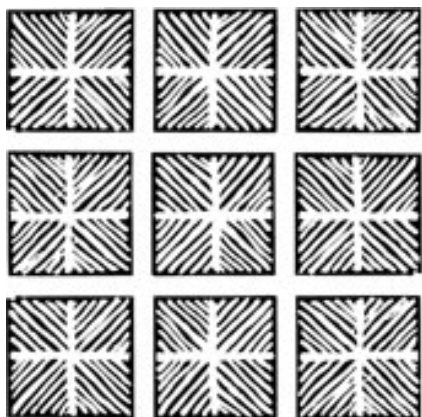

GRAFOMOTRICIDAD

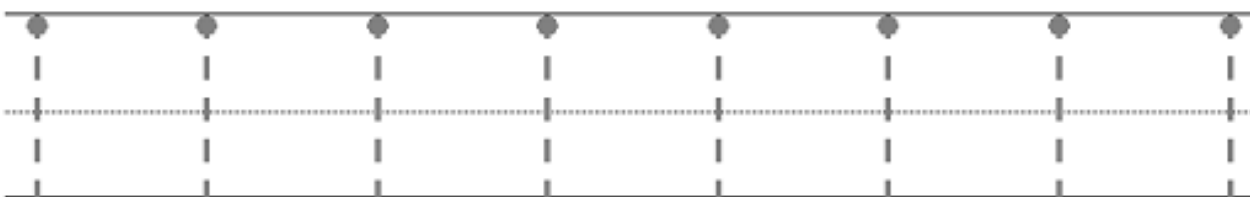
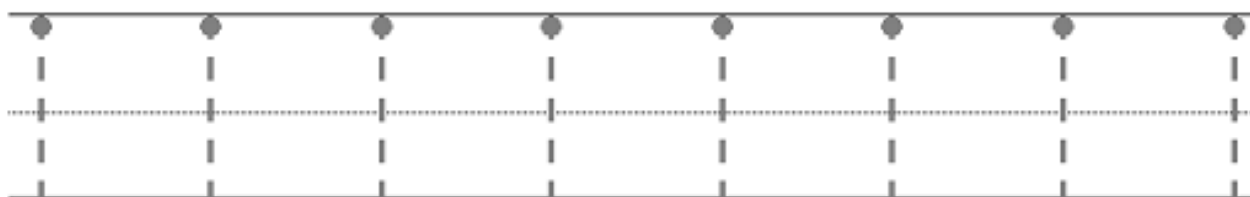
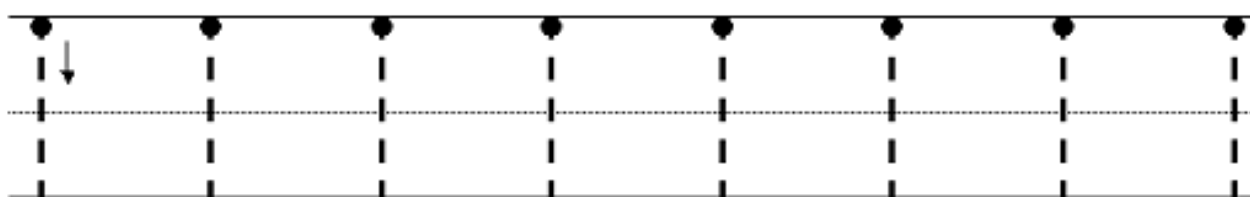
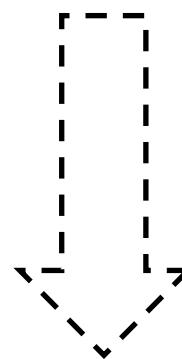
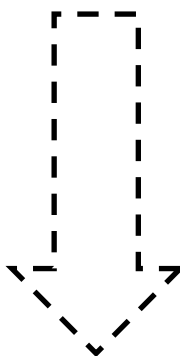
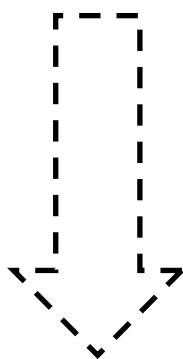

Más material en



<https://orientacionandujar.wordpress.com/>

GRAFOMOTRICIDAD

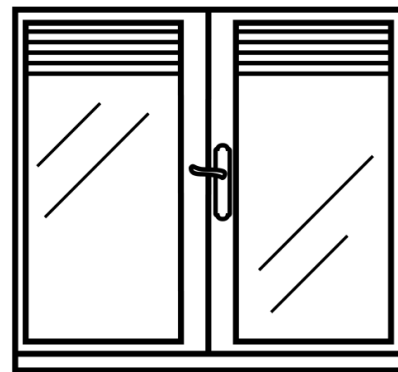
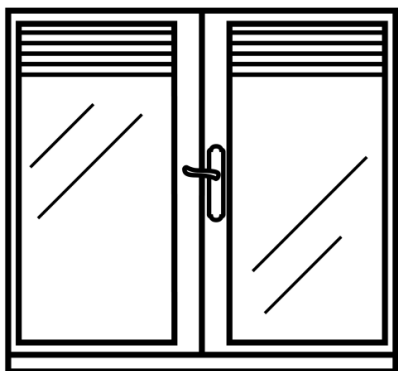

Handwriting practice lines consisting of five rows. Each row has a solid top line, a dashed middle line, and a solid bottom line. The first row contains eight vertical dashed lines, each starting with a black dot and a downward arrow indicating the starting point and direction. The second row contains eight vertical dashed lines, each starting with a black dot. The third row contains three vertical dashed lines, each starting with a black dot. The fourth row contains eight vertical dashed lines, each starting with a black dot. The fifth row contains three vertical dashed lines, each starting with a black dot.



GRAFOMOTRICIDAD

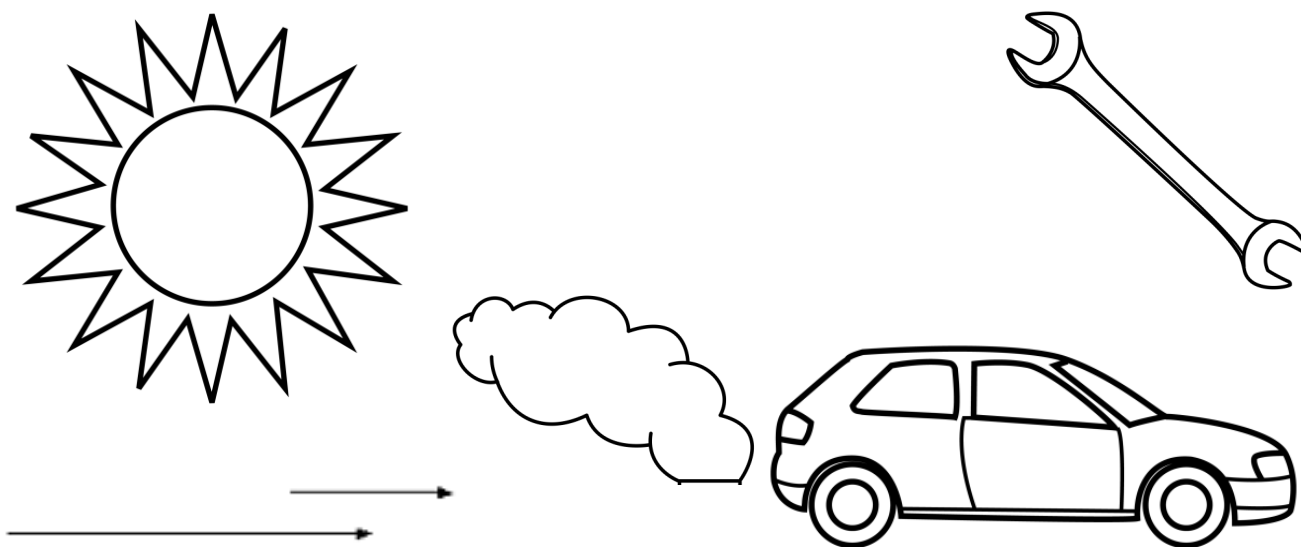

Tracing practice lines consisting of solid top and bottom lines with a dashed middle line. Each line has a starting dot and a small arrow pointing right. There are four such sets of lines, with the first two having arrows and the last two being empty for practice.

Más material en



<https://orientacionandujar.wordpress.com/>

GRAFOMOTRICIDAD

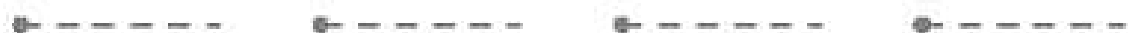
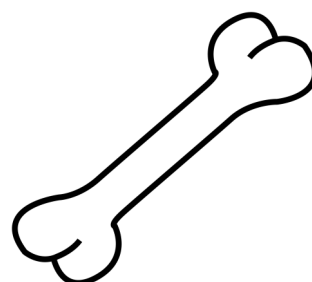
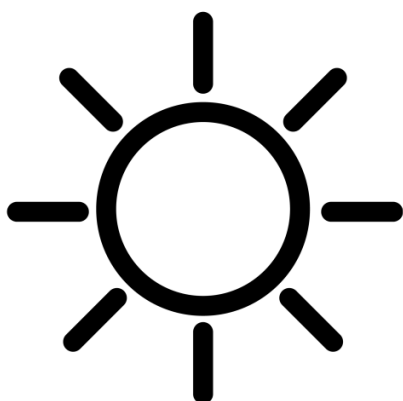

Más material en 

<https://orientacionandujar.wordpress.com/>

GRAFOMOTRICIDAD

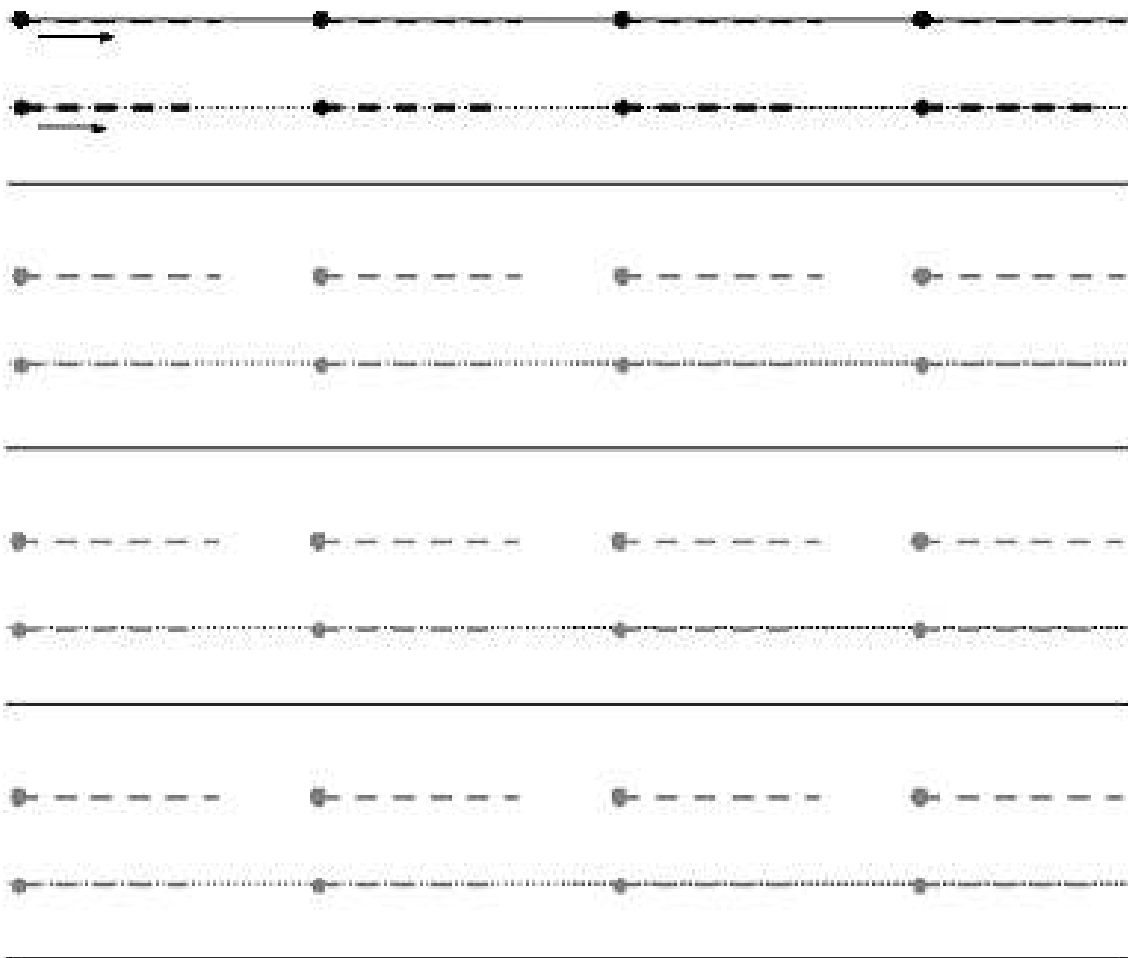
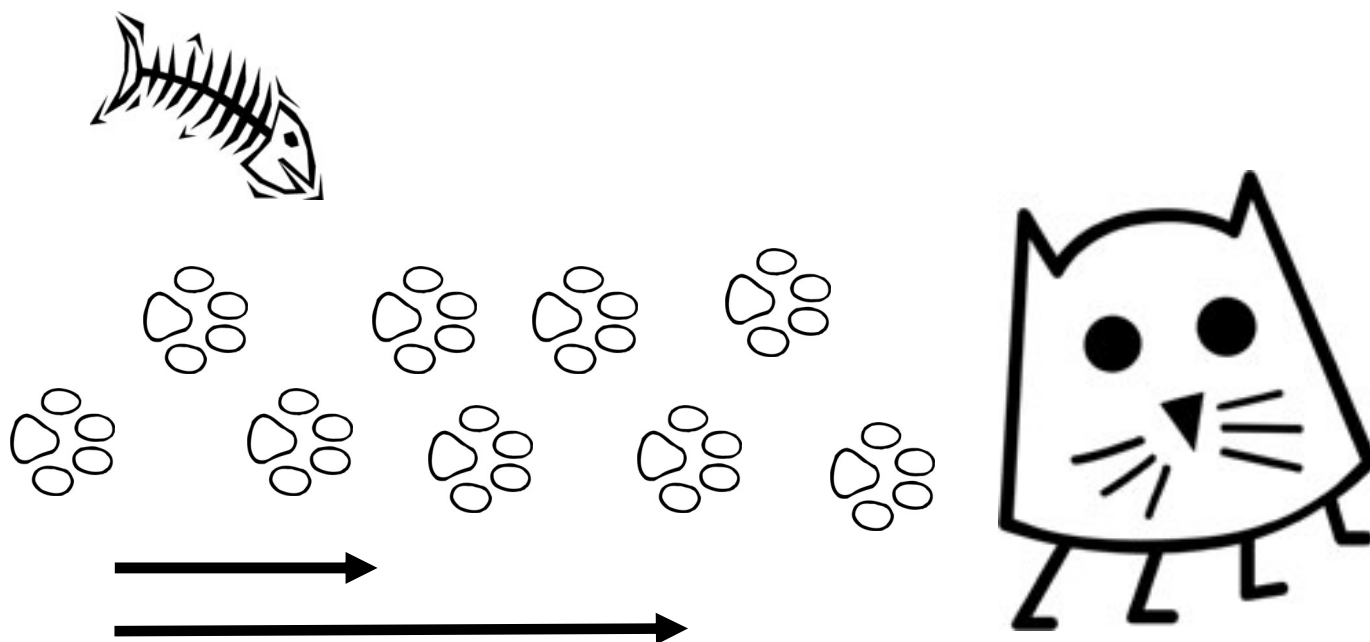

GRAFOMOTRICIDAD

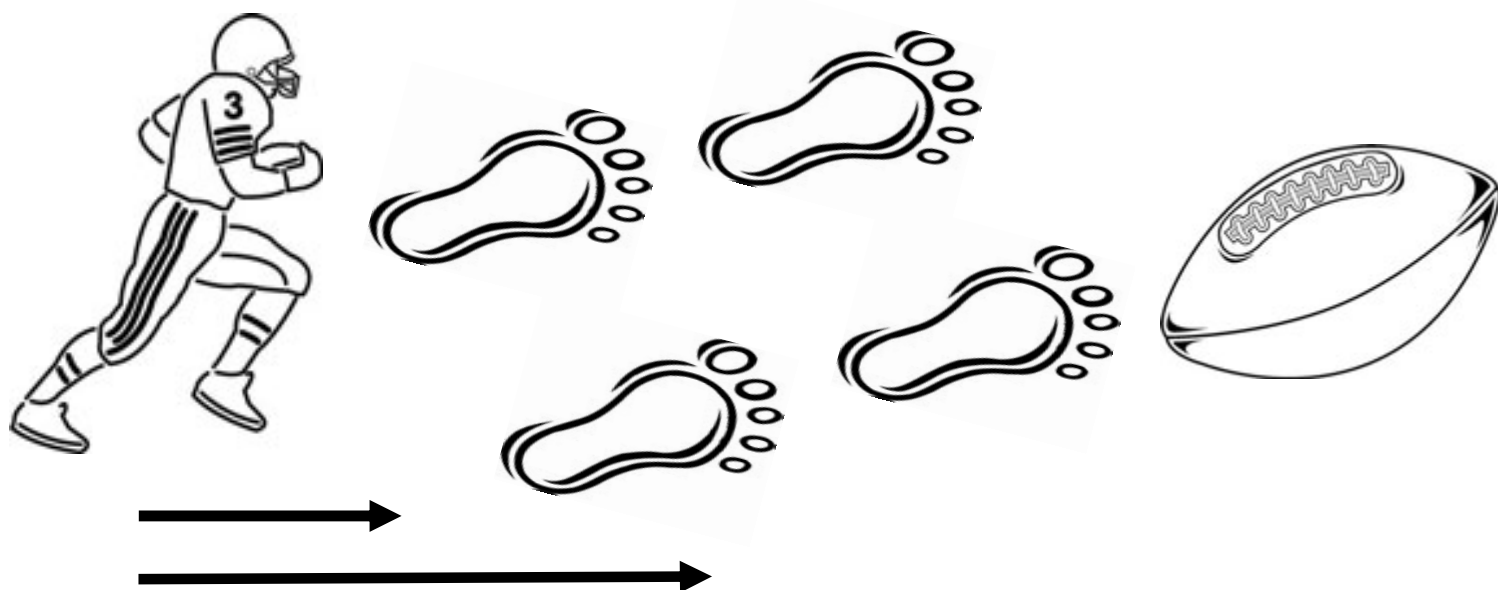

Tracing practice lines consisting of four rows. Each row contains a solid top line, a dashed middle line, and a solid bottom line. The first two rows include small arrows on the left side of the dashed line to indicate the direction of tracing. The first row has four segments, and the second row has three segments. The third and fourth rows each have four segments.

Más material en



<https://orientacionandujar.wordpress.com/>

GRAFOMOTRICIDAD

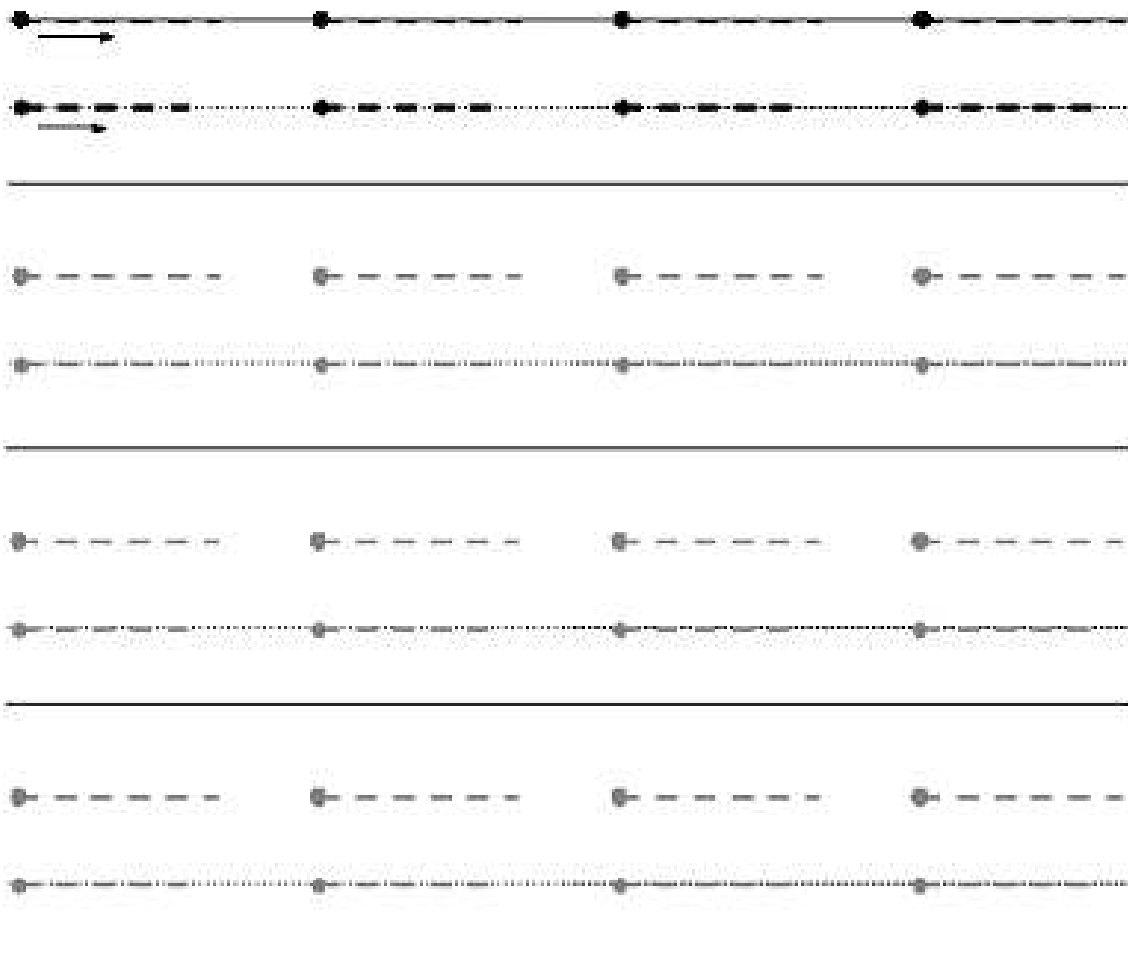
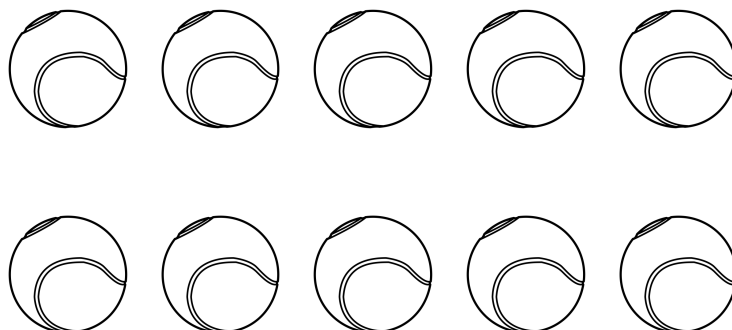

GRAFOMOTRICIDAD

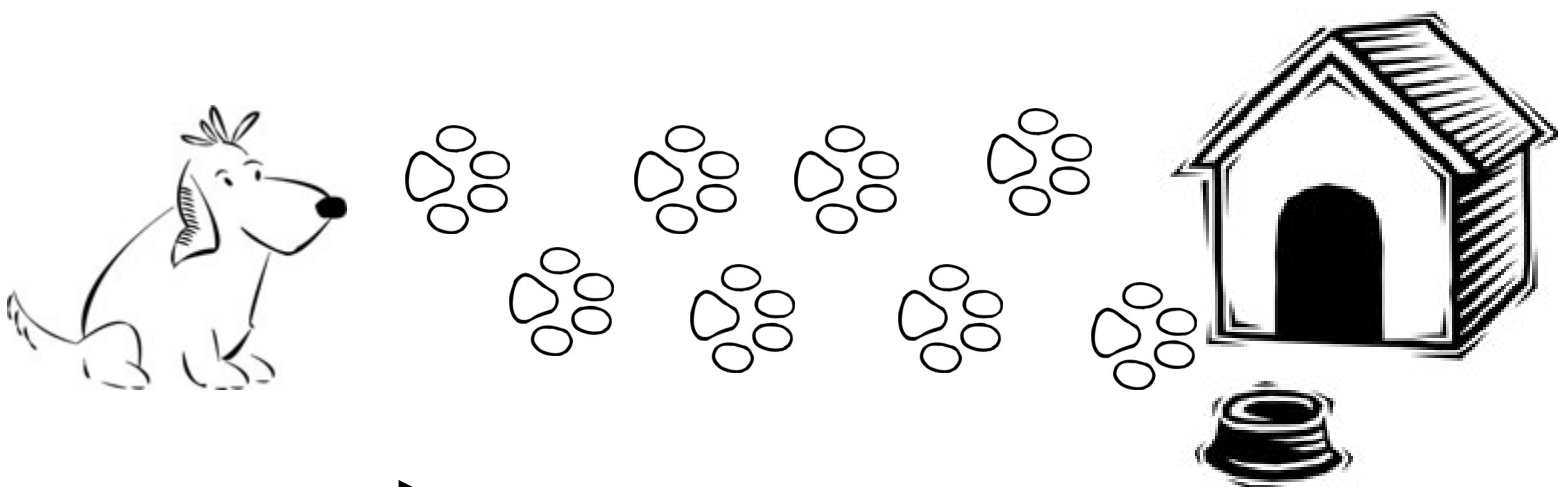

Tracing practice area consisting of multiple rows of horizontal lines. Each row includes a solid top line, a dashed middle line, and a solid bottom line. The first two rows have small arrows on the dashed middle line pointing to the right, indicating the direction of tracing. The remaining rows are for independent practice.

Más material en



<https://orientacionandujar.wordpress.com/>

GRAFOMOTRICIDAD

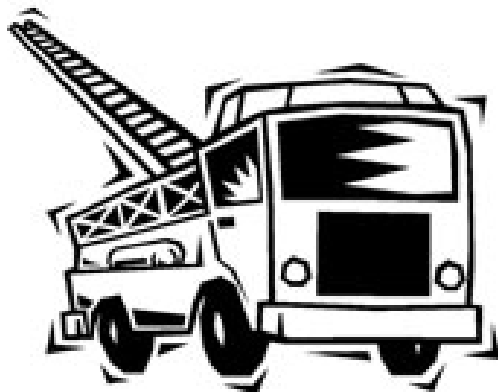

Tracing practice area consisting of multiple rows of horizontal lines. Each row includes a solid top line, a dashed middle line, and a solid bottom line. The first two rows have small arrows on the dashed middle line indicating the direction of tracing from left to right. The remaining rows are blank for independent practice.

Más material en



<https://orientacionandujar.wordpress.com/>

GRAFOMOTRICIDAD

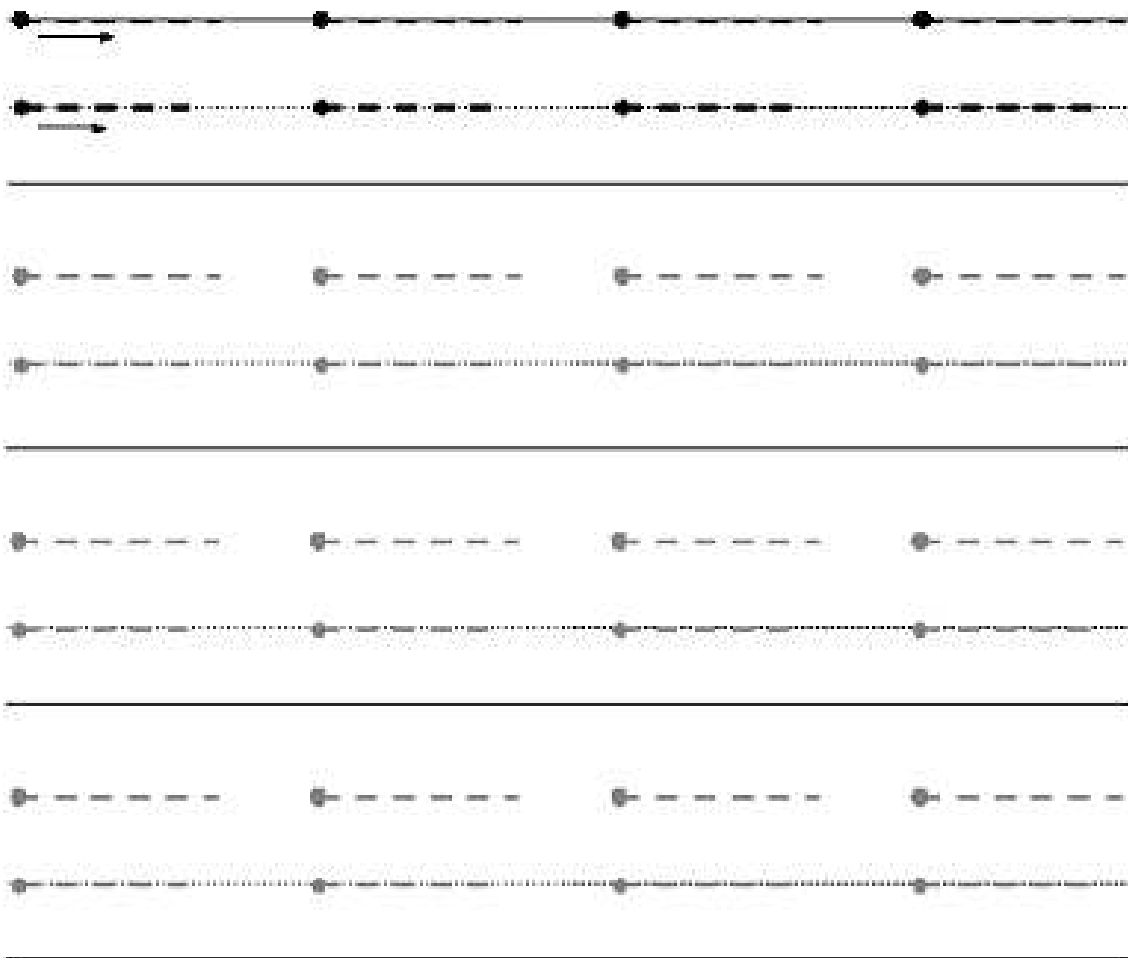
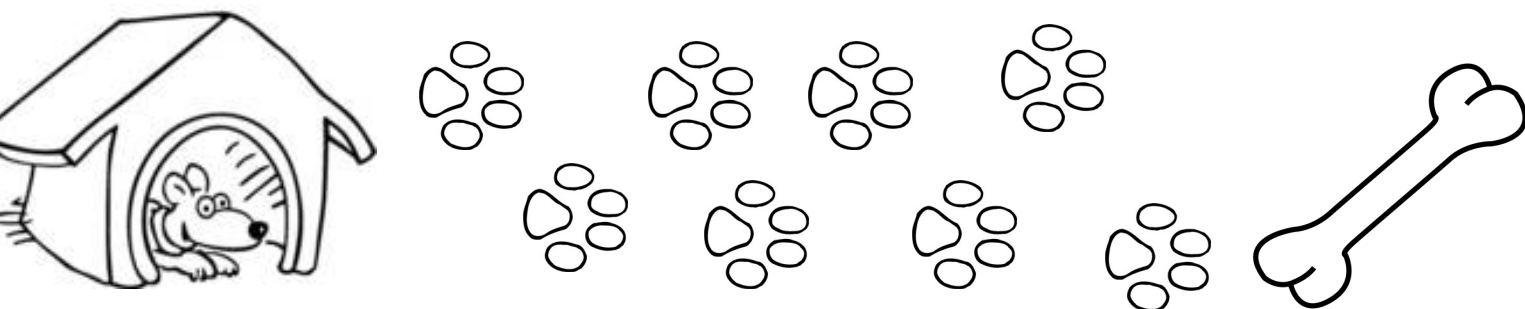

Más material en



<https://orientacionandujar.wordpress.com/>

GRAFOMOTRICIDAD

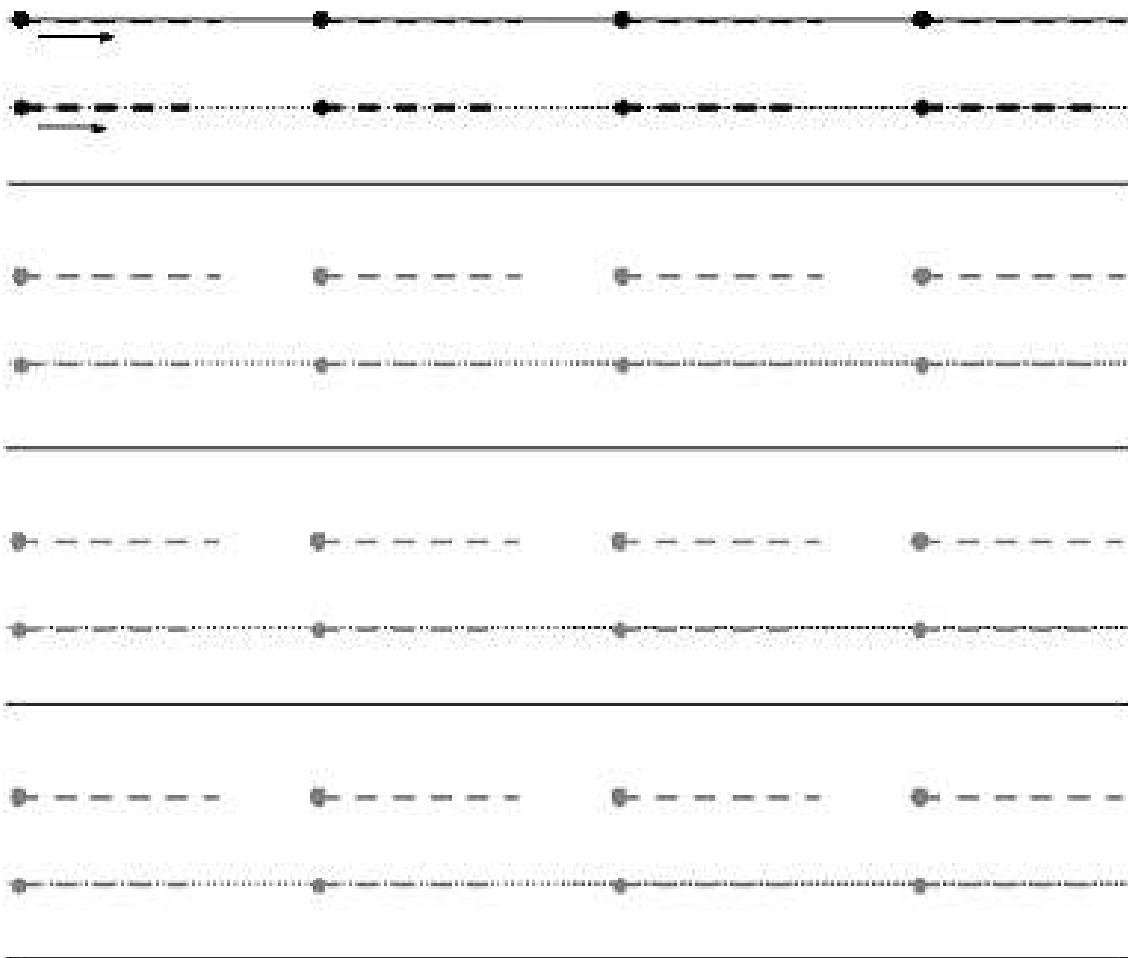
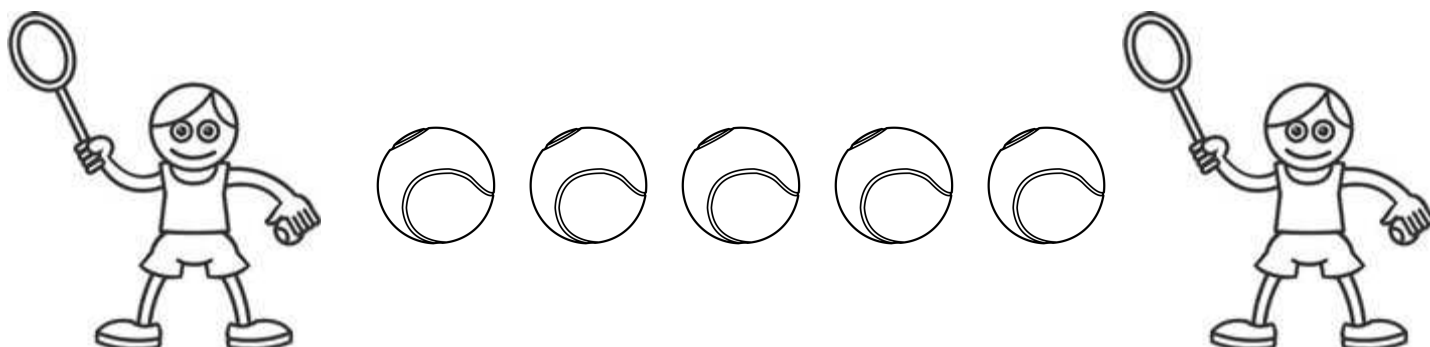

GRAFOMOTRICIDAD

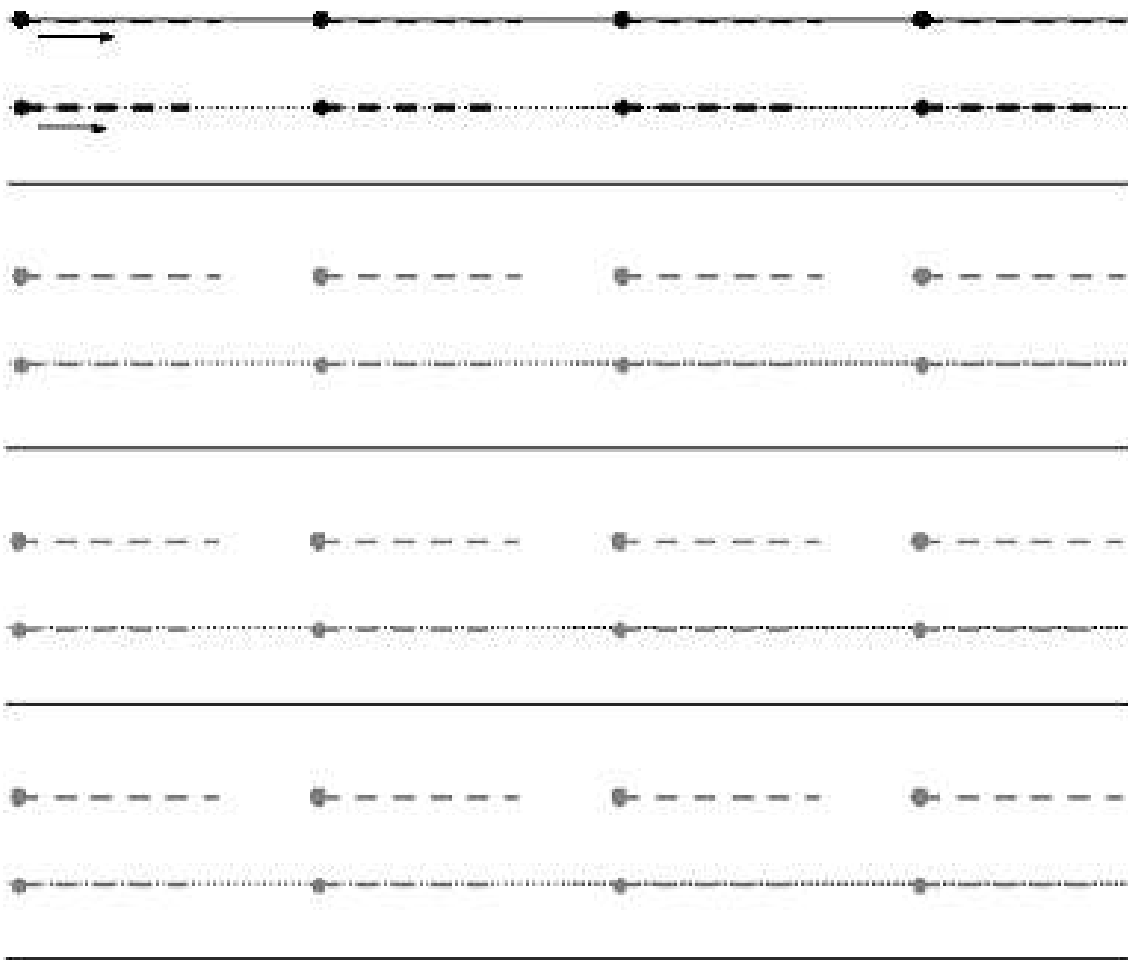
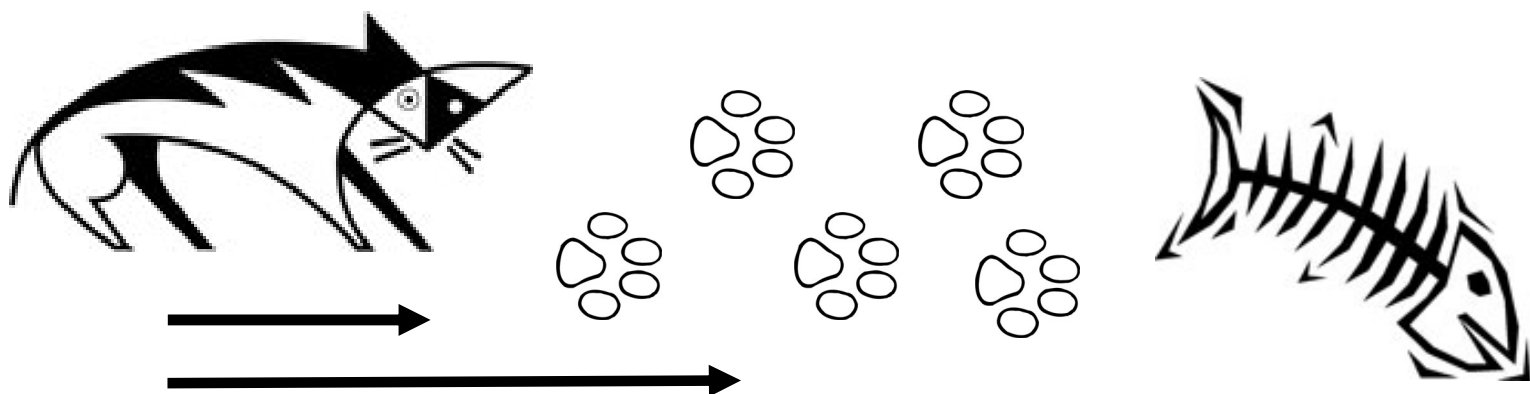

Más material en



<https://orientacionandujar.wordpress.com/>

GRAFOMOTRICIDAD

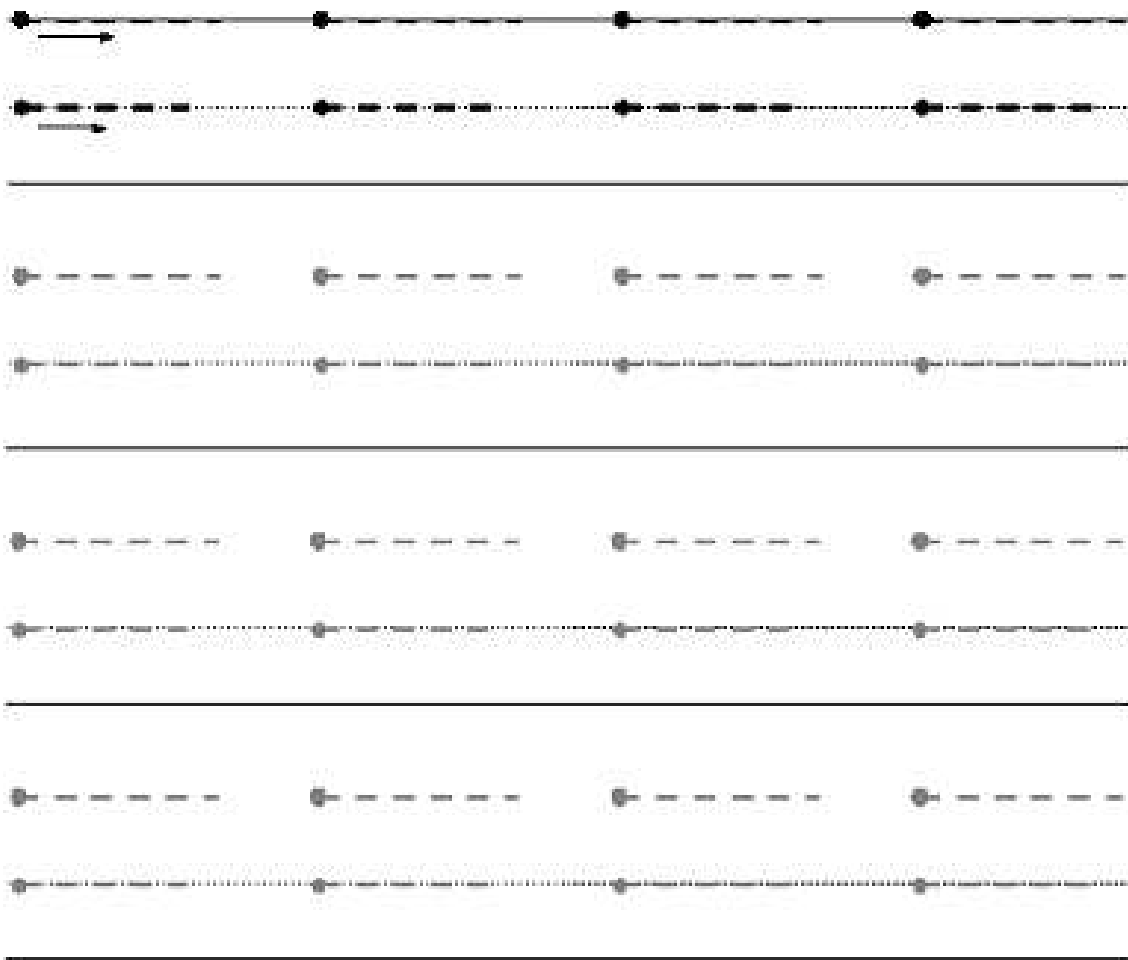
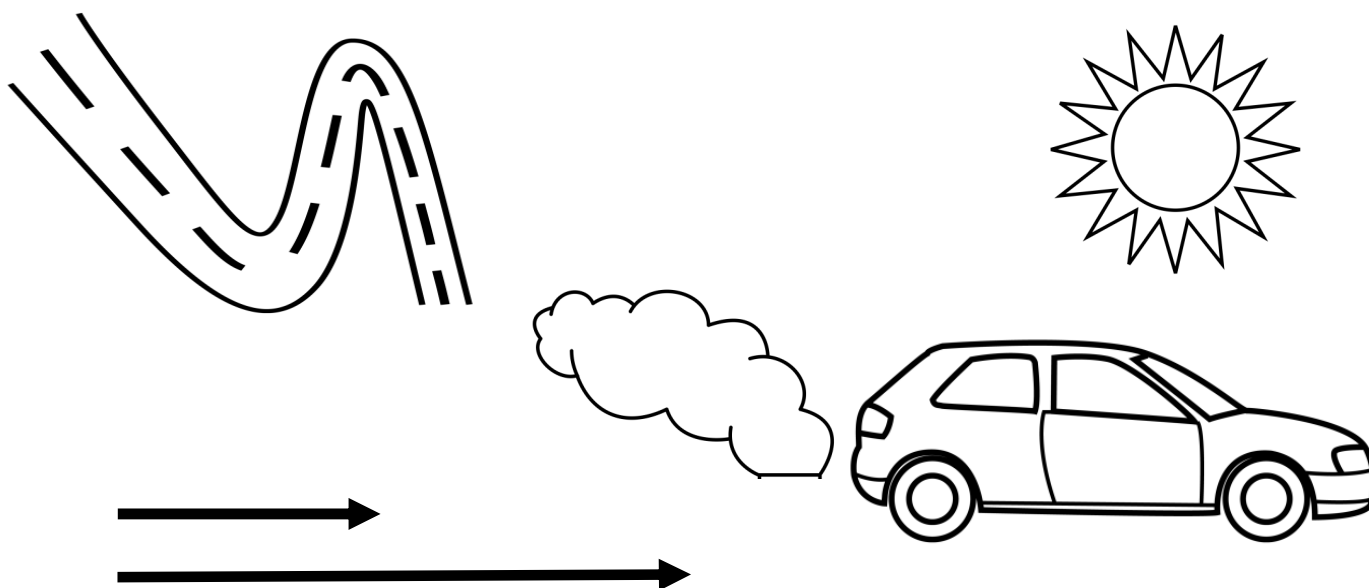

Más material en



<https://orientacionandujar.wordpress.com/>

GRAFOMOTRICIDAD

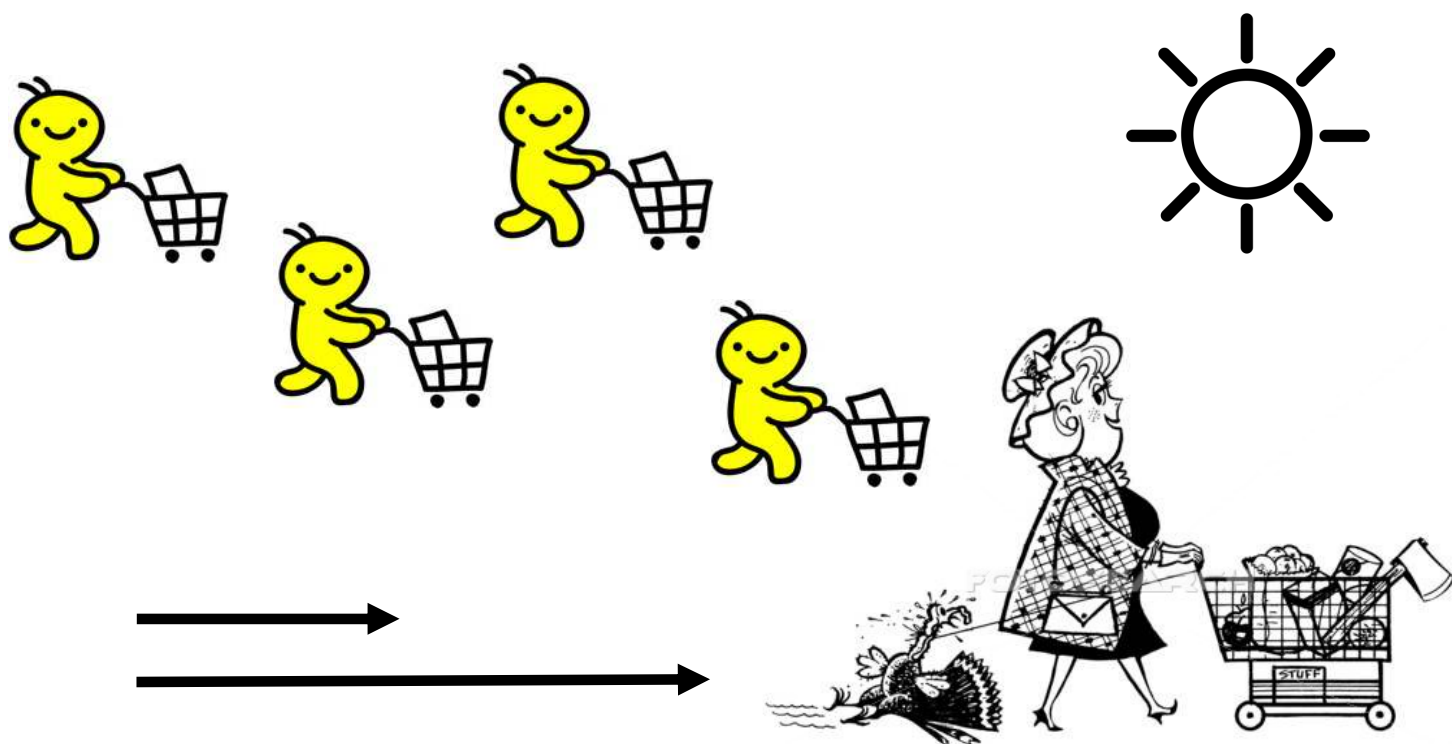

Tracing practice lines consisting of four rows of horizontal lines. Each row contains a solid top line, a dashed middle line, and a solid bottom line. The first two rows have small arrows indicating the direction of the stroke. The first row has four segments, and the second row has five segments. The remaining two rows have four segments each.

Más material en



<https://orientacionandujar.wordpress.com/>

GRAFOMOTRICIDAD

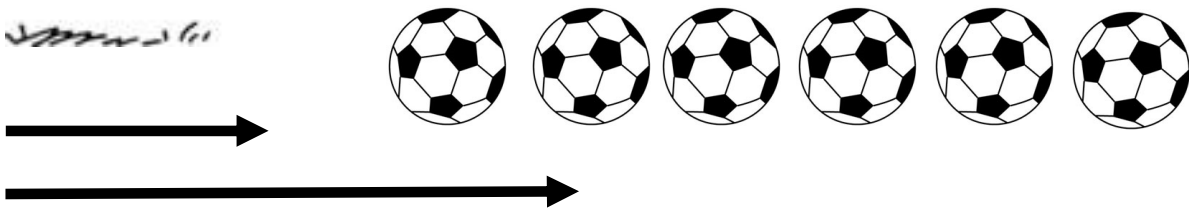
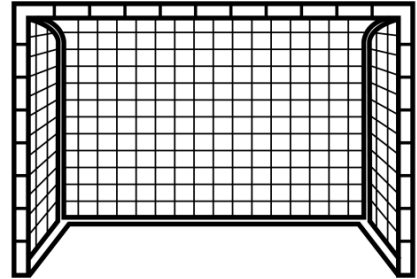

GRAFOMOTRICIDAD

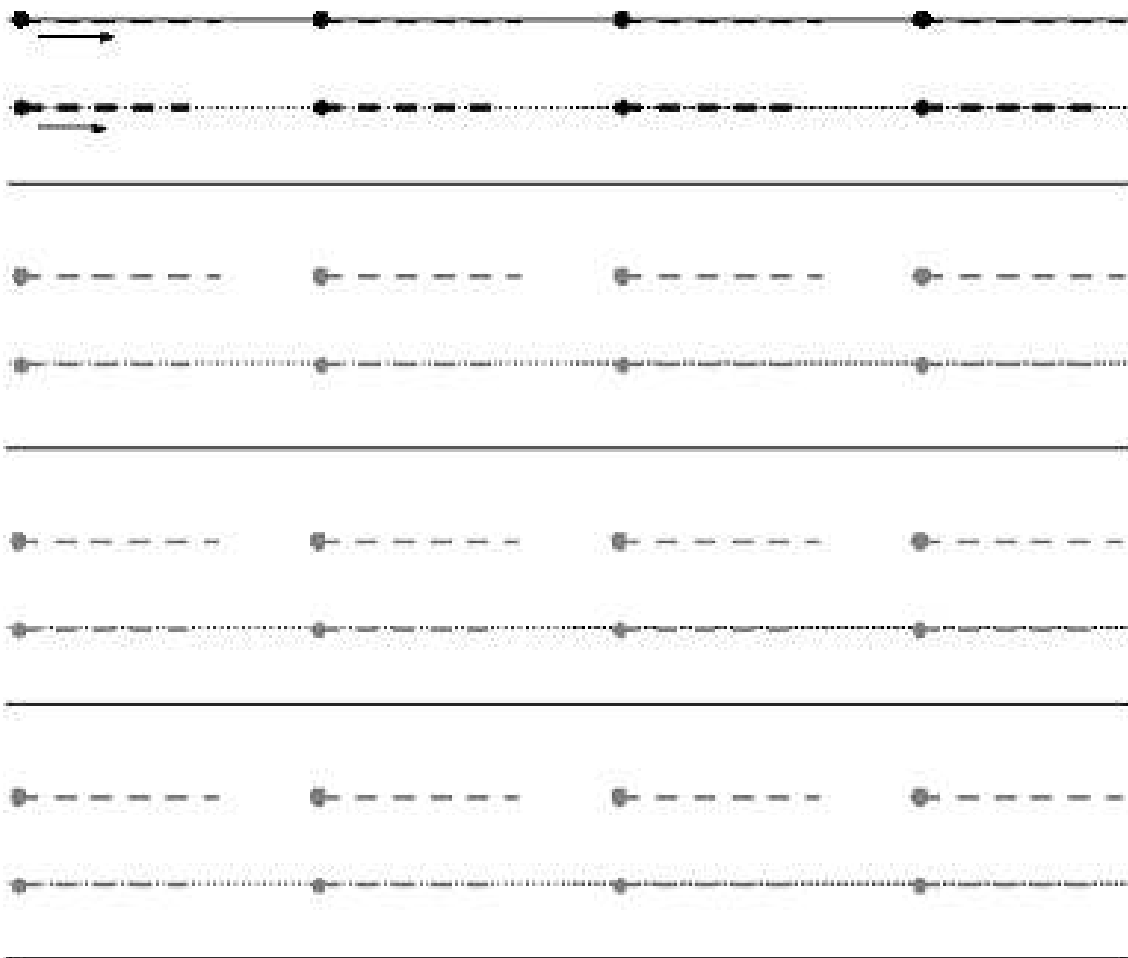
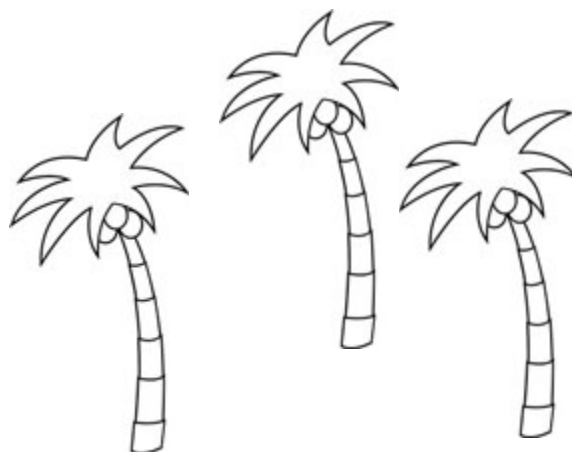
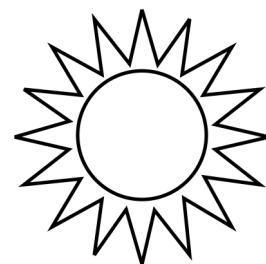

GRAFOMOTRICIDAD

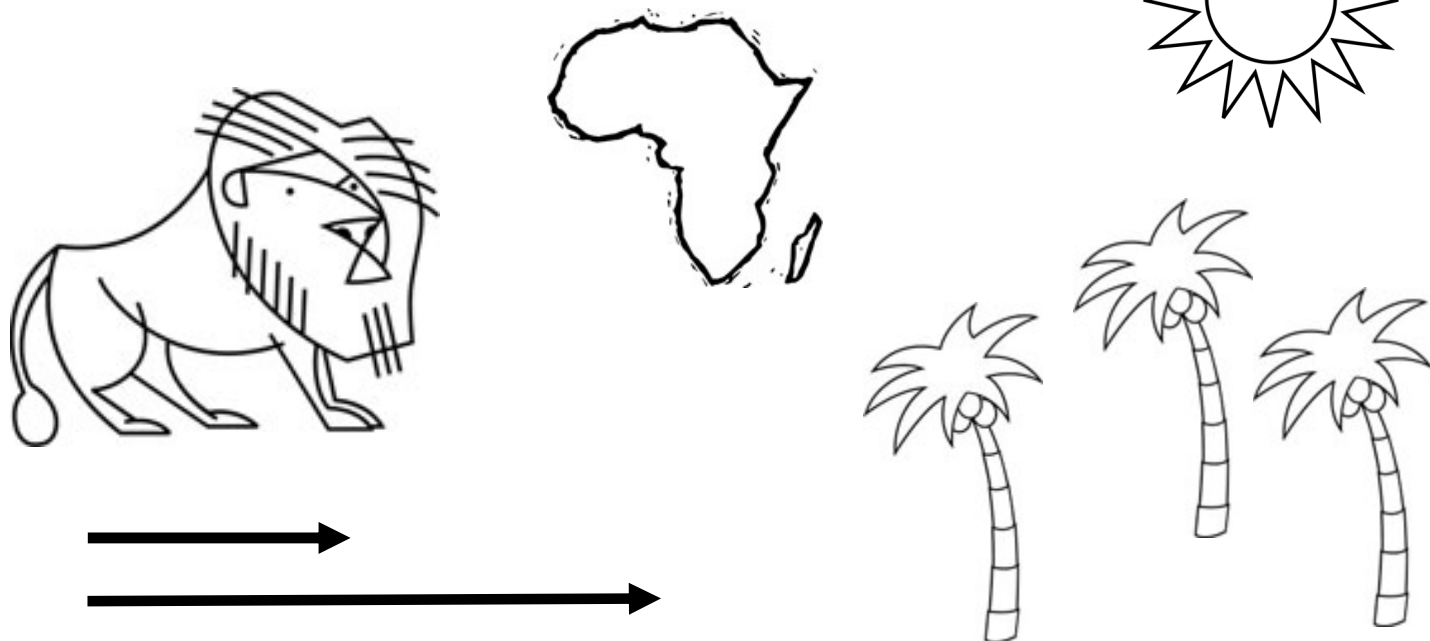

Tracing practice lines consisting of four rows. Each row contains a solid top line, a dashed middle line, and a solid bottom line. The first two rows include small arrows on the dashed lines to indicate the direction of writing. The first row has four segments, and the subsequent rows have four segments each.



GRAFOMOTRICIDAD

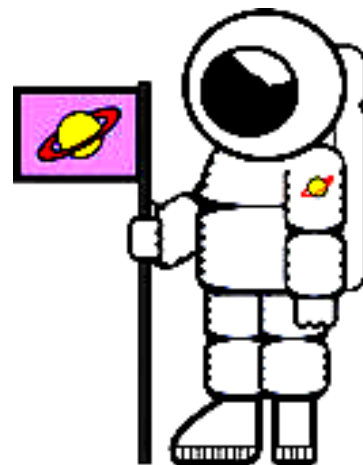

Tracing practice area consisting of four sets of horizontal lines. Each set includes a solid top line, a dashed middle line, and a solid bottom line. The first two sets have small arrows indicating the direction of the stroke. The first set has four segments, and the second set has three segments. The third and fourth sets each have four segments.

Más material en



<https://orientacionandujar.wordpress.com/>

GRAFOMOTRICIDAD

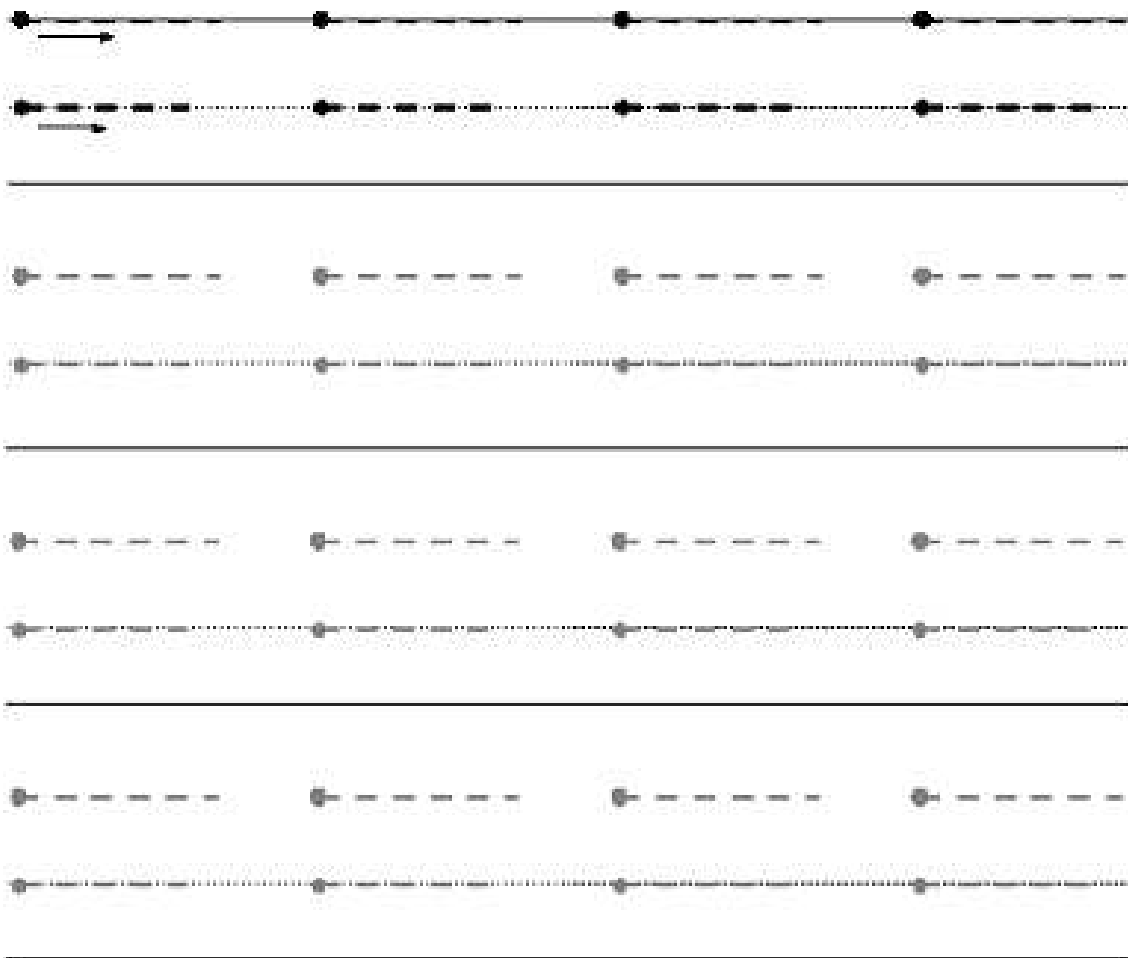

GRAFOMOTRICIDAD

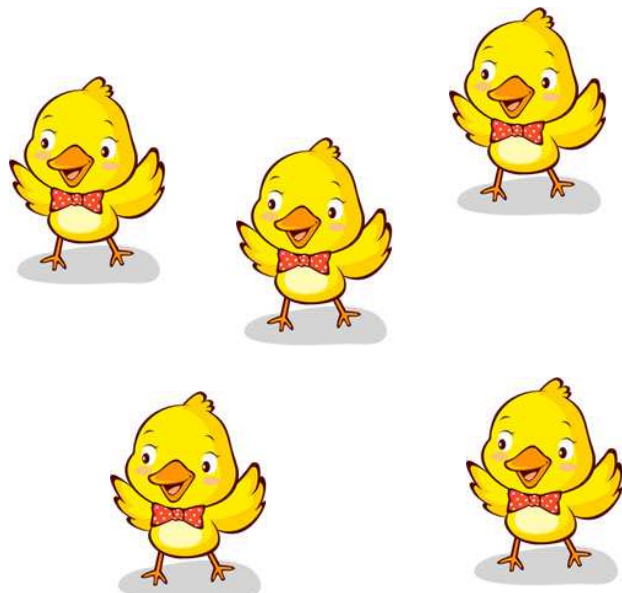

Tracing practice lines consisting of four rows. Each row has a solid top line and a solid bottom line. The first two rows include a dashed line between the solid lines, with a small arrow pointing right at the start of the dashed line. The last two rows only have the solid lines.

Más material en



<https://orientacionandujar.wordpress.com/>

GRAFOMOTRICIDAD

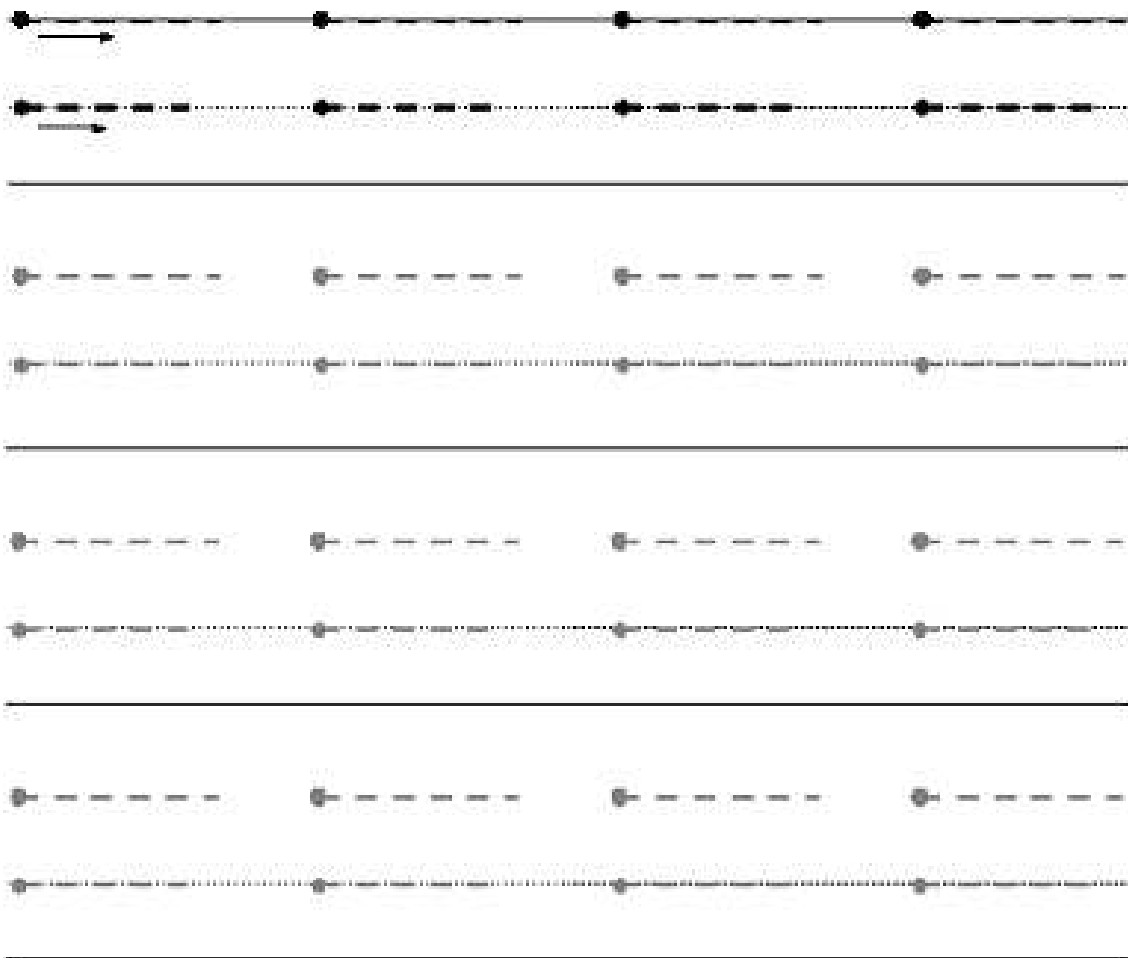

GRAFOMOTRICIDAD

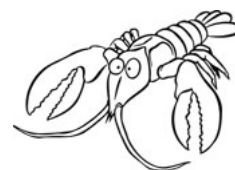
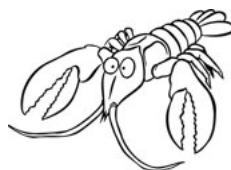
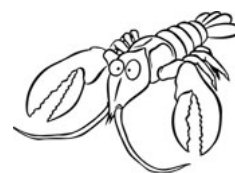
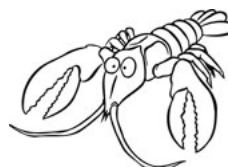

Más material en



<https://orientacionandujar.wordpress.com/>

GRAFOMOTRICIDAD

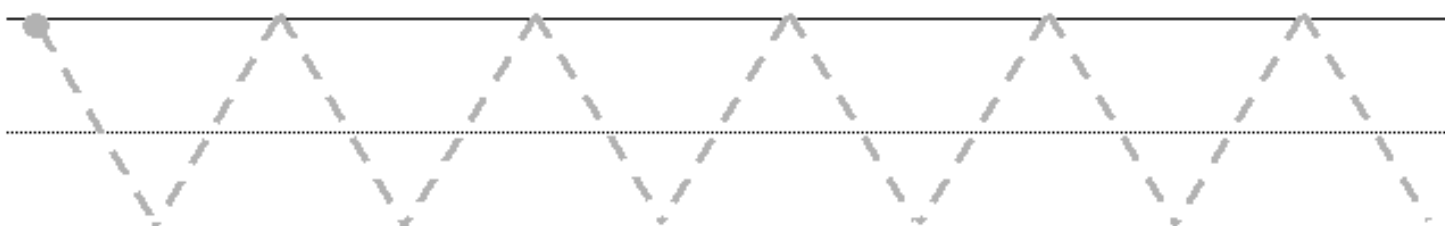
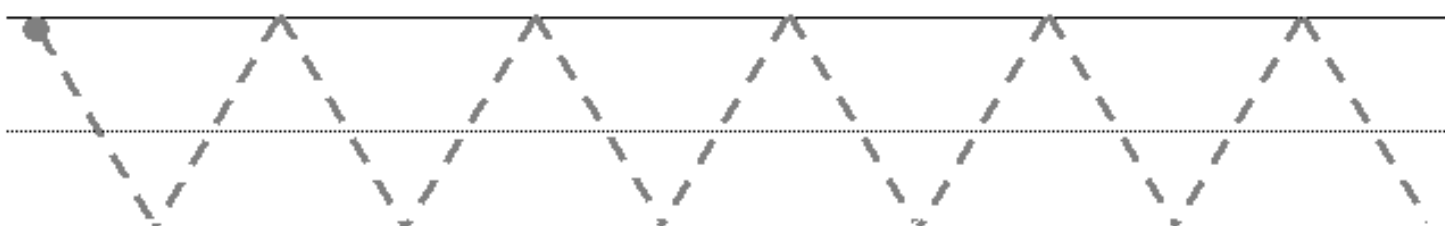
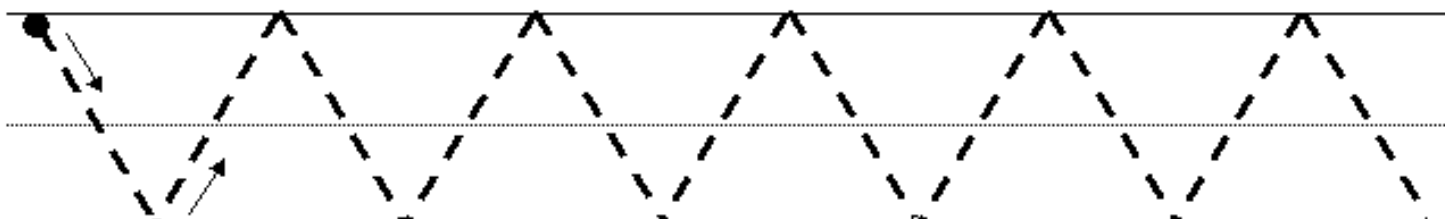
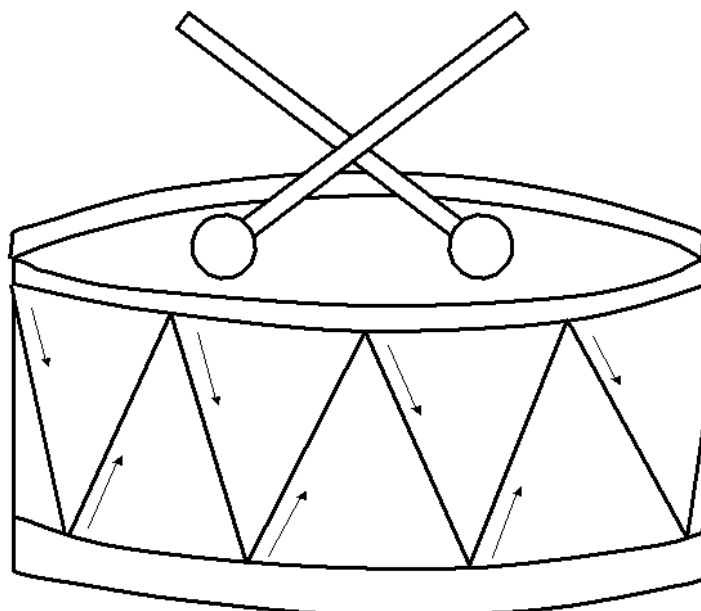

Más material en



<https://orientacionandujar.wordpress.com/>

GRAFOMOTRICIDAD

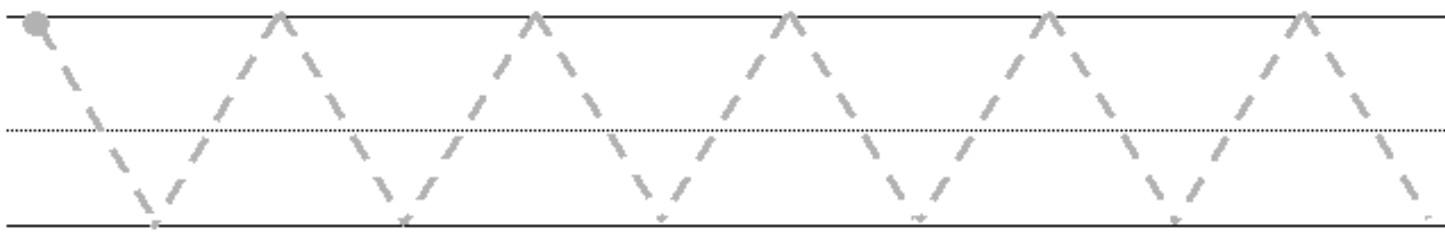
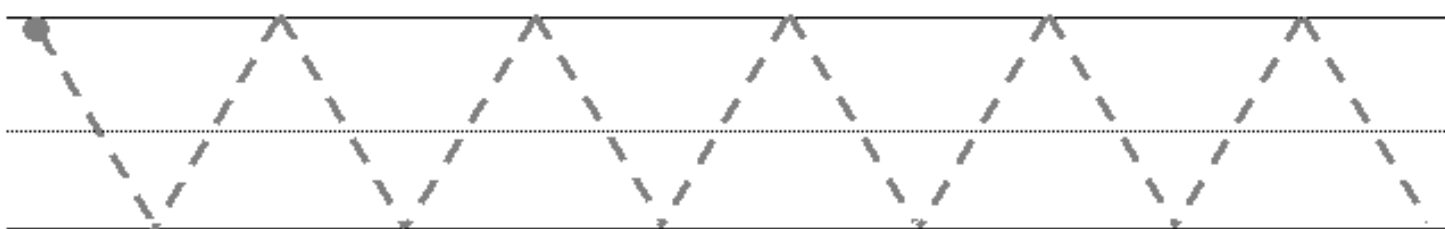
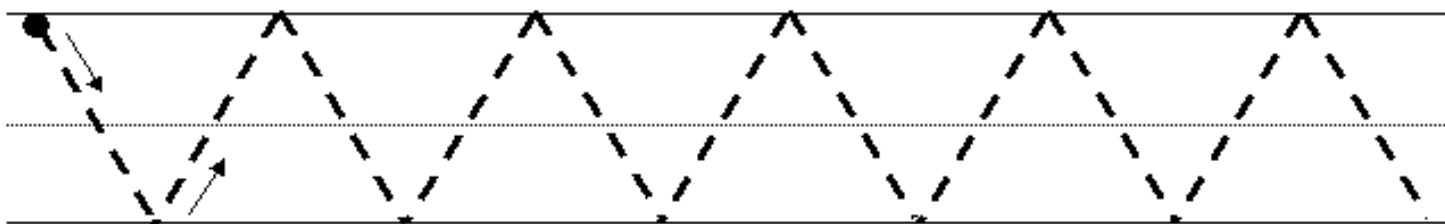
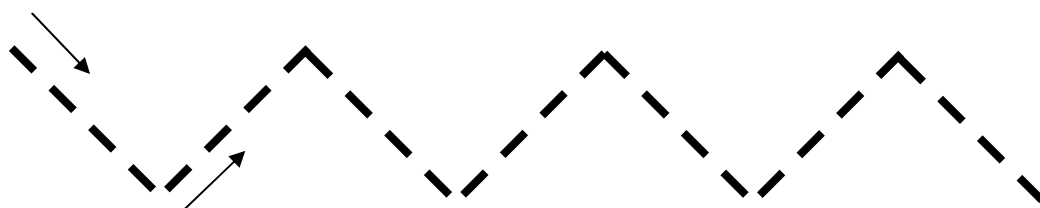
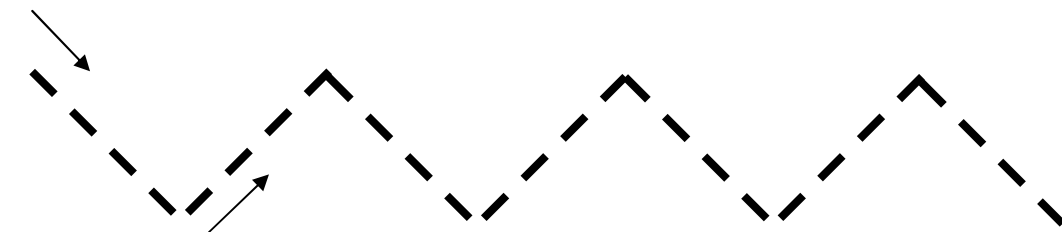

Más material en



<https://orientacionandujar.wordpress.com/>

GRAFOMOTRICIDAD

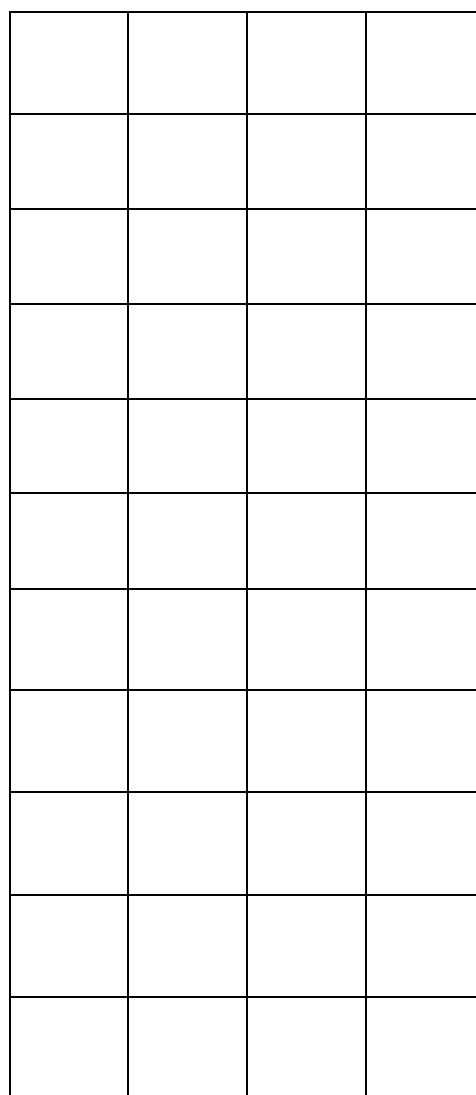
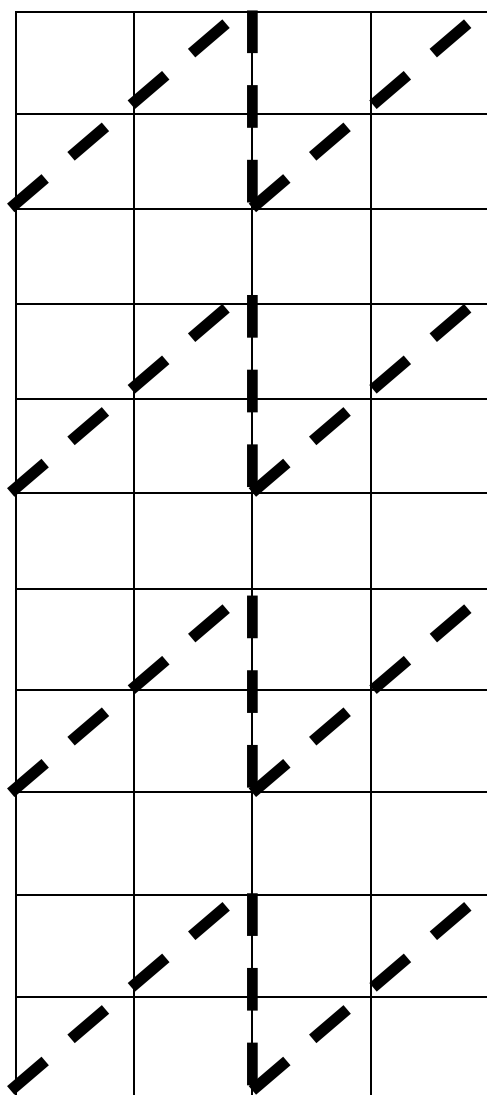
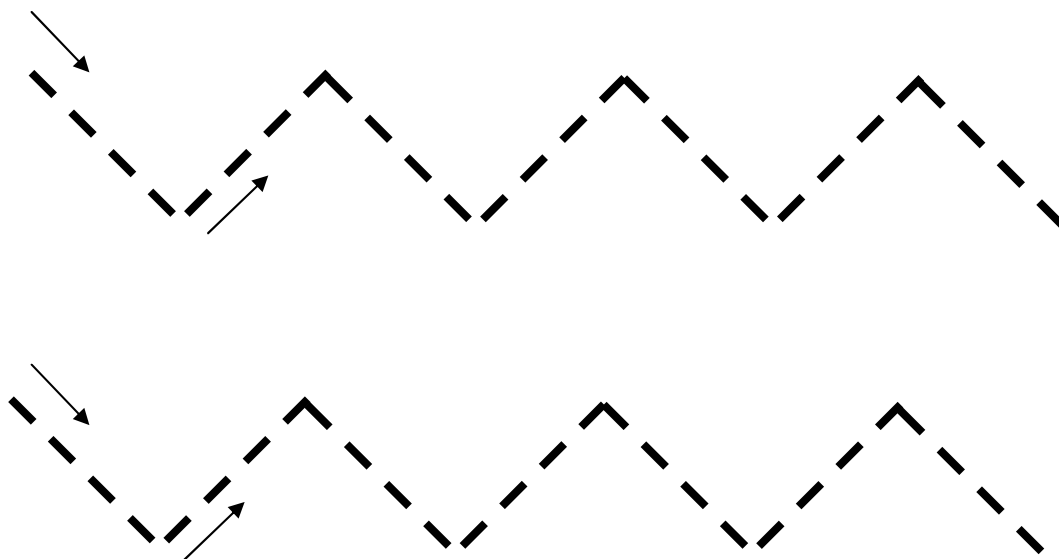

Más material en



<https://orientacionandujar.wordpress.com/>

GRAFOMOTRICIDAD

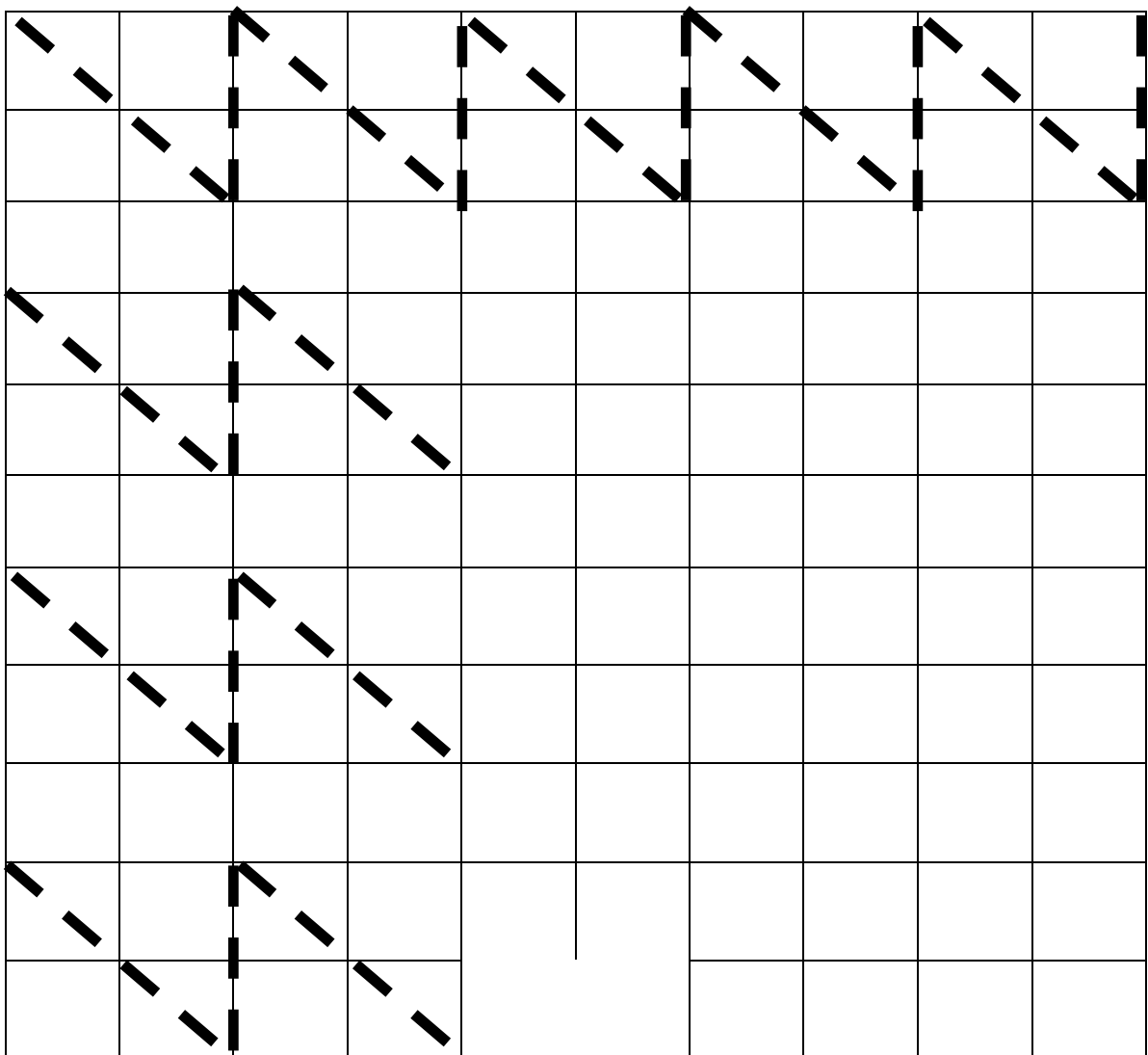
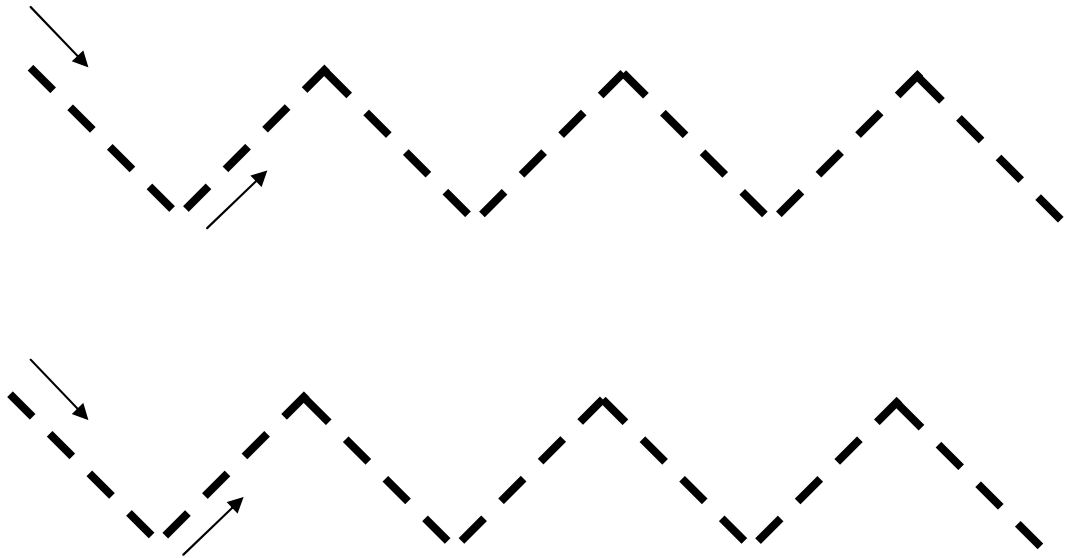

Más material en



<https://orientacionandujar.wordpress.com/>

GRAFOMOTRICIDAD

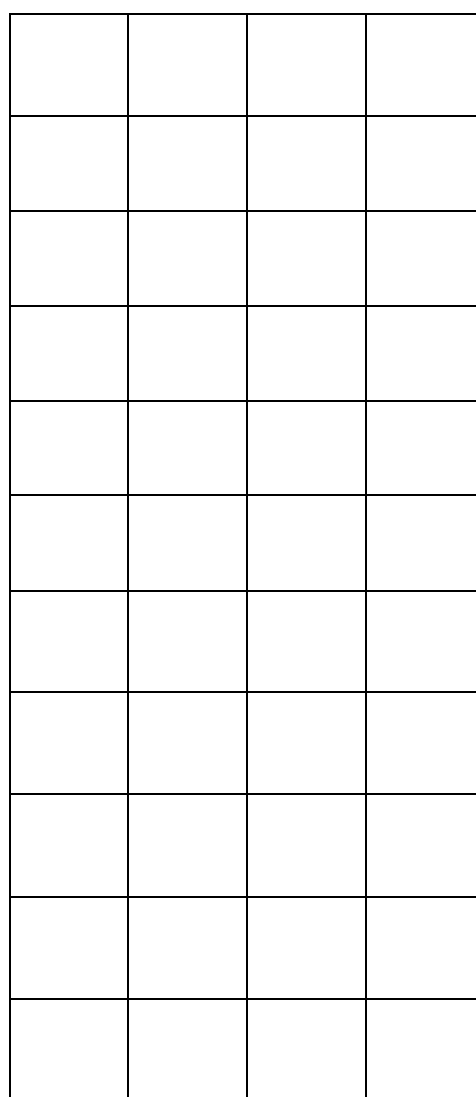
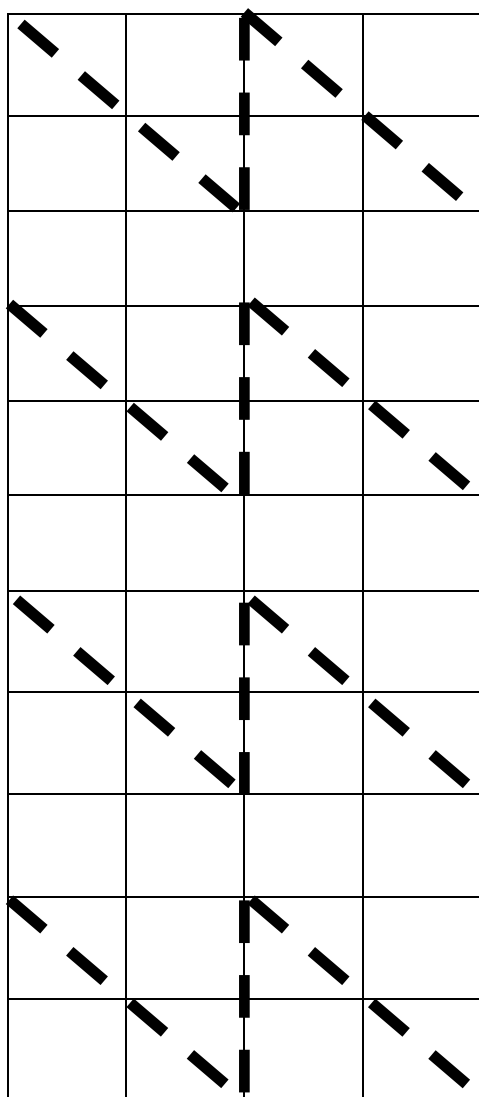
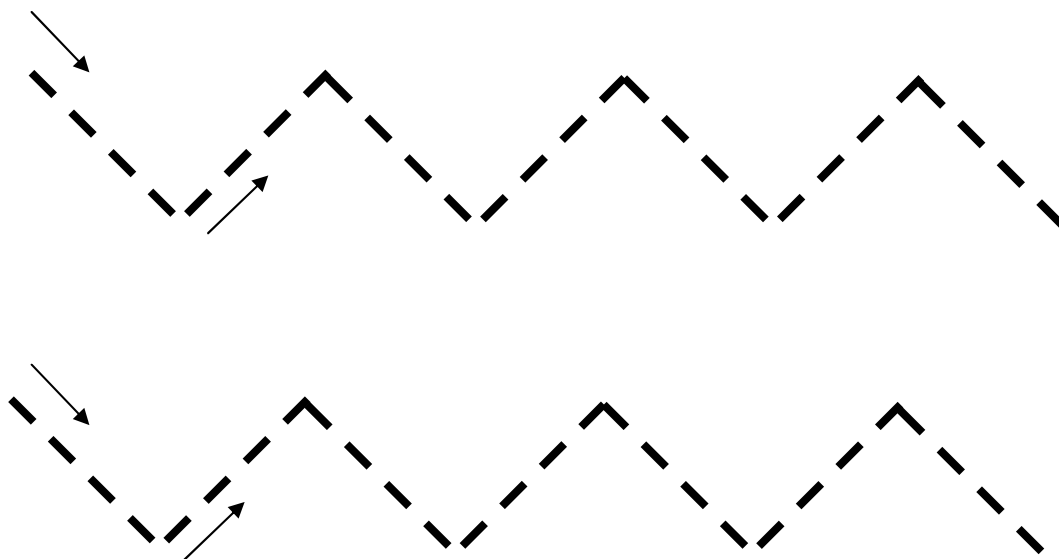

Más material en



<https://orientacionandujar.wordpress.com/>

GRAFOMOTRICIDAD

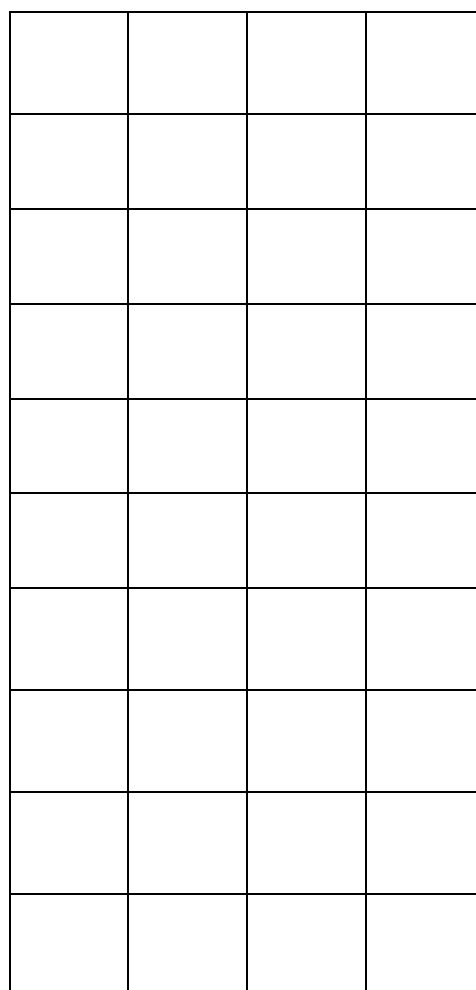
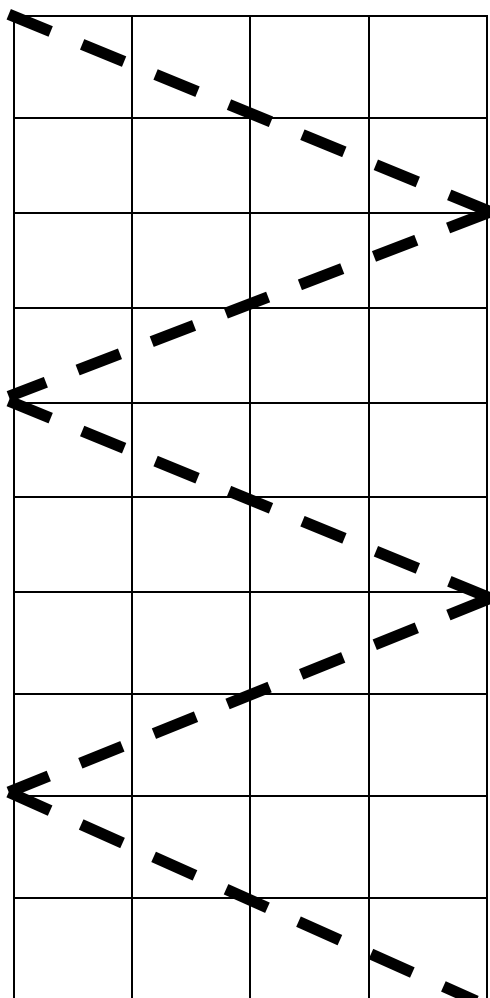
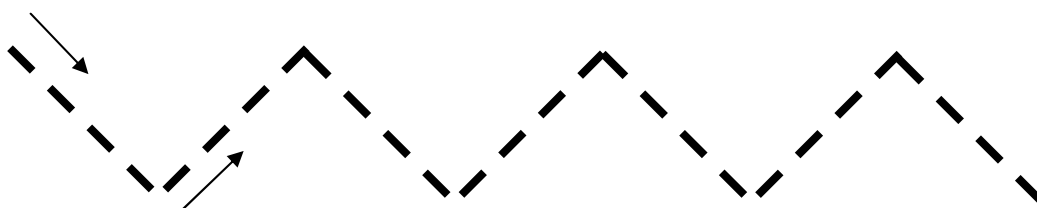
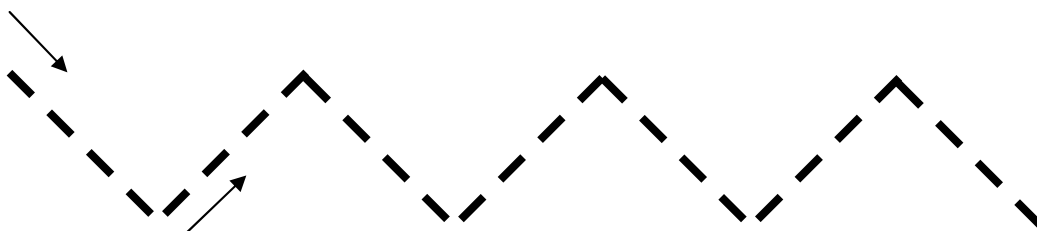

GRAFOMOTRICIDAD

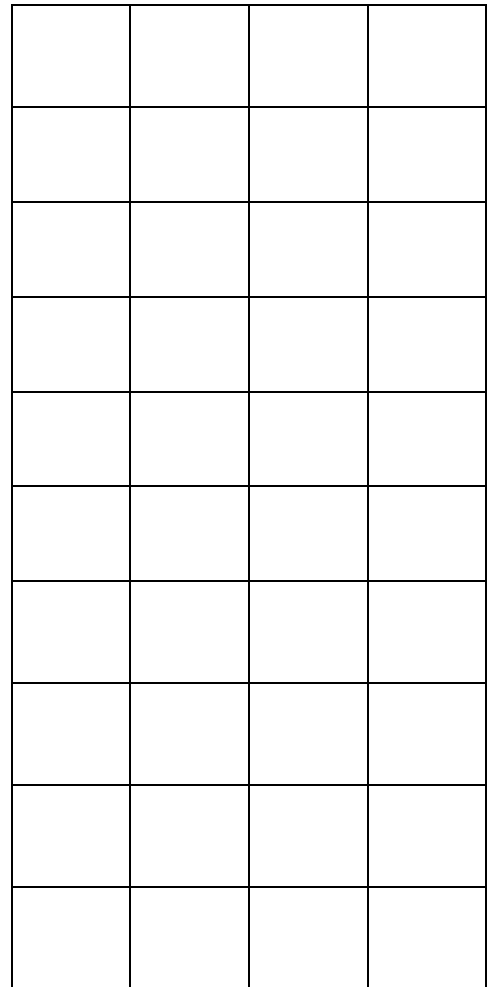
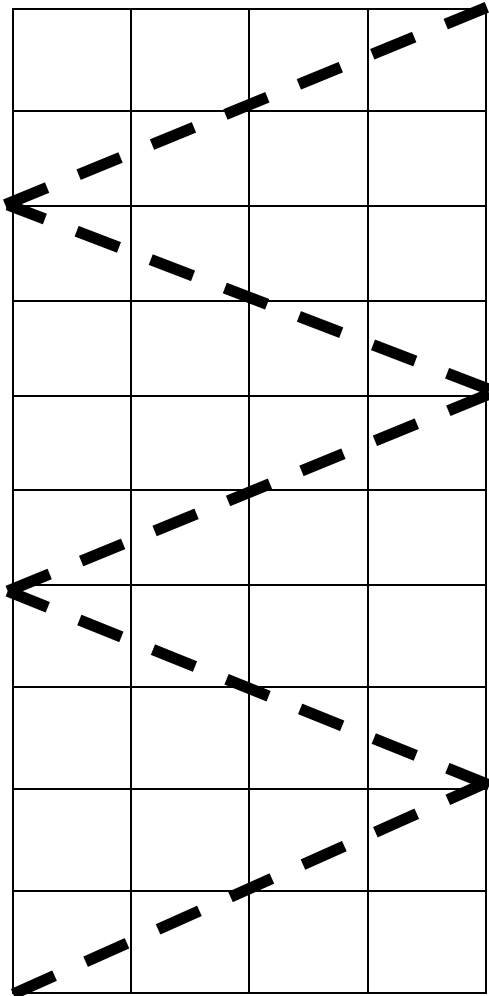
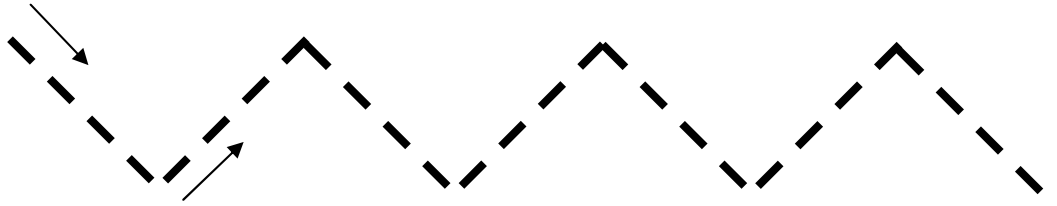
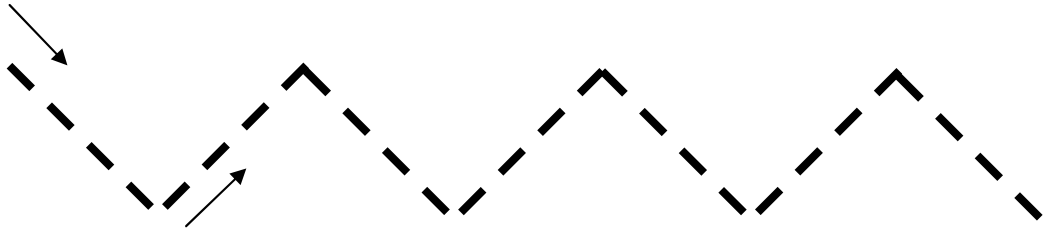

GRAFOMOTRICIDAD

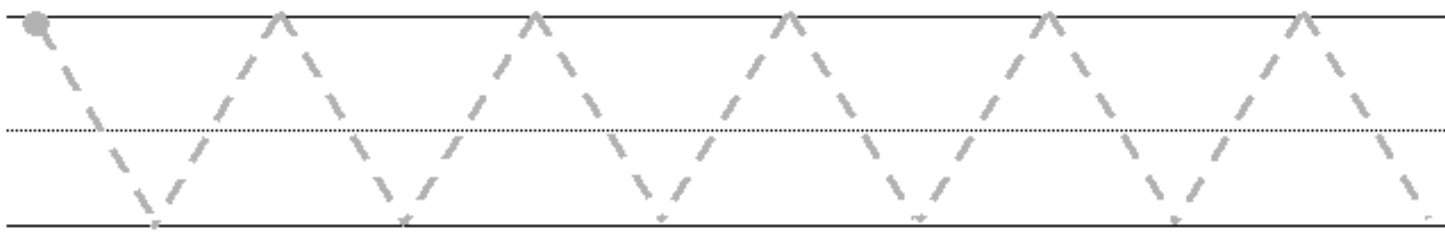
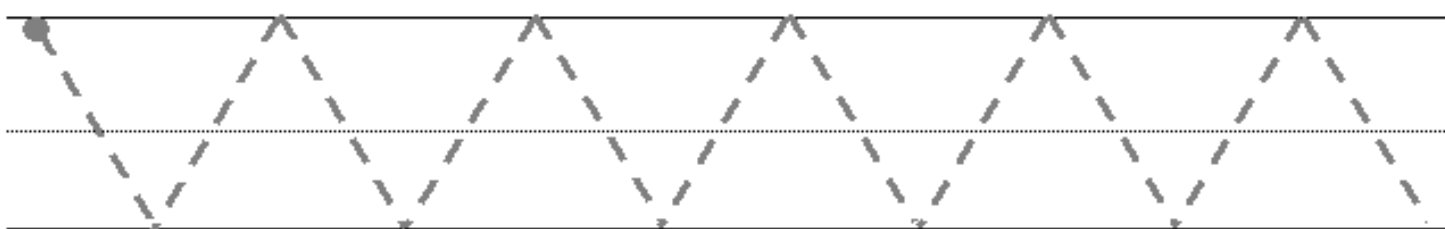
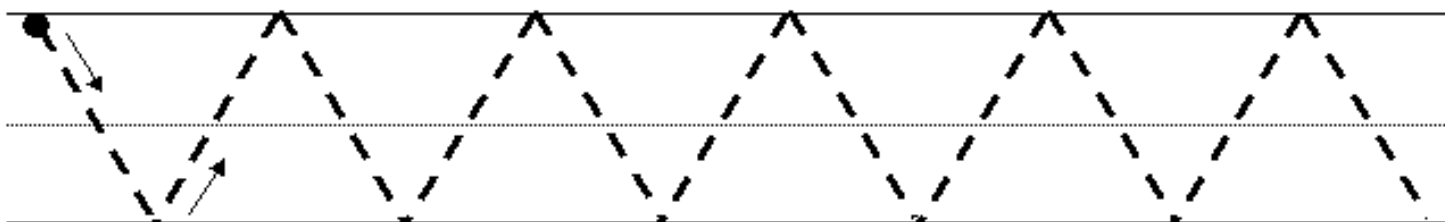
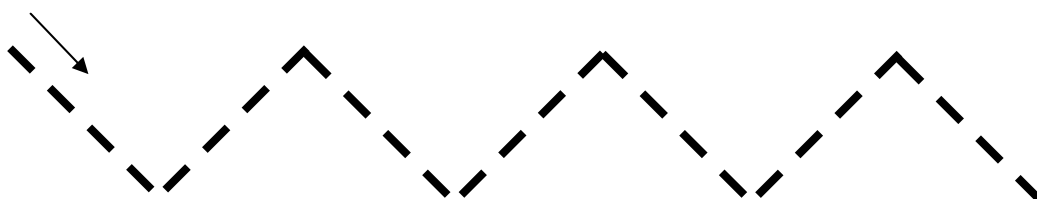
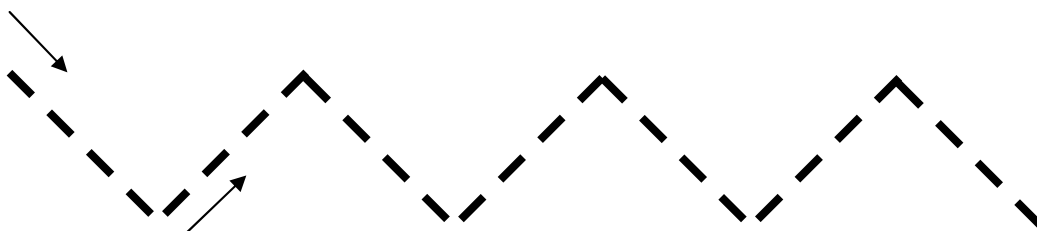

Más material en



<https://orientacionandujar.wordpress.com/>

GRAFOMOTRICIDAD

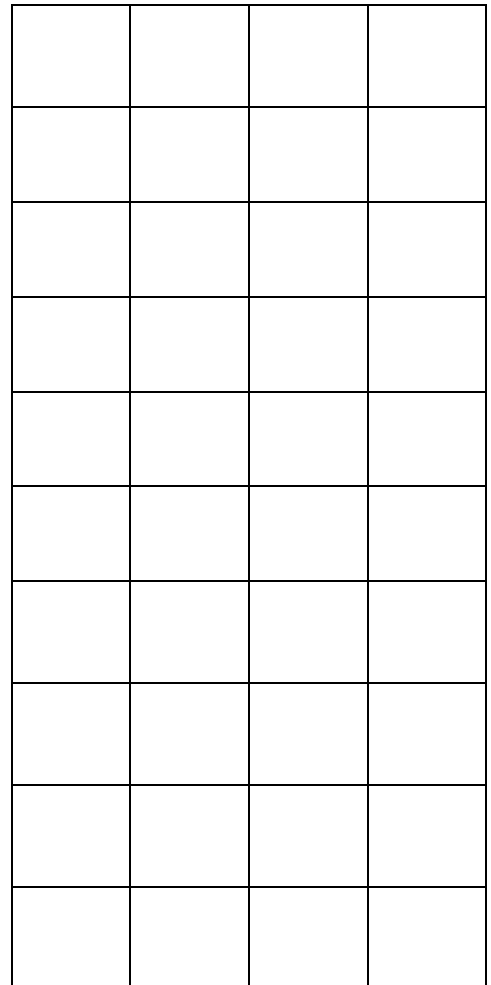
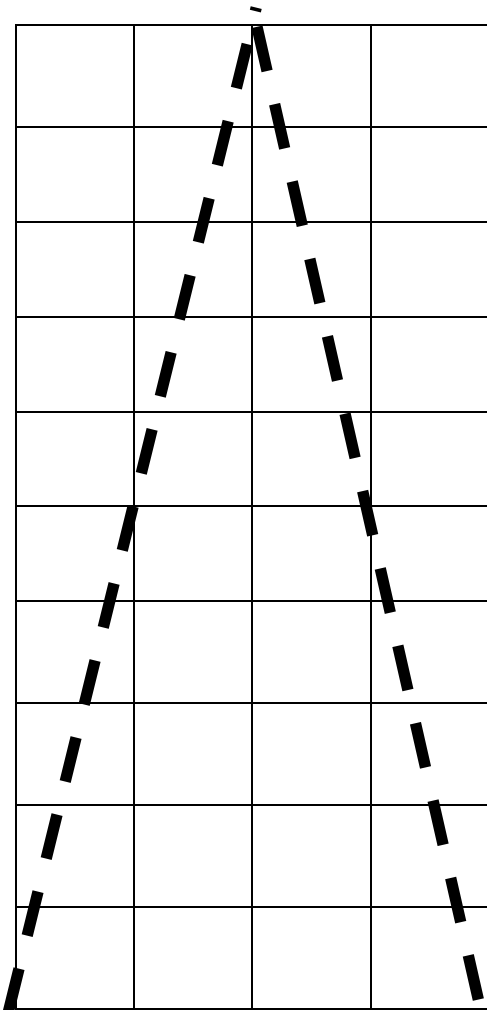
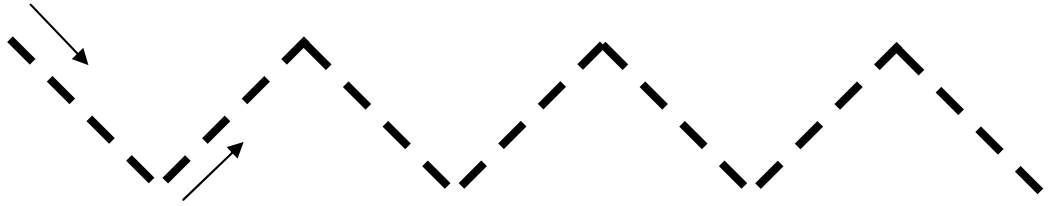
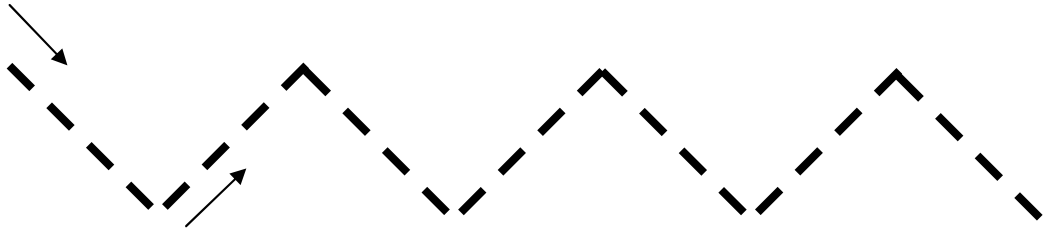

GRAFOMOTRICIDAD

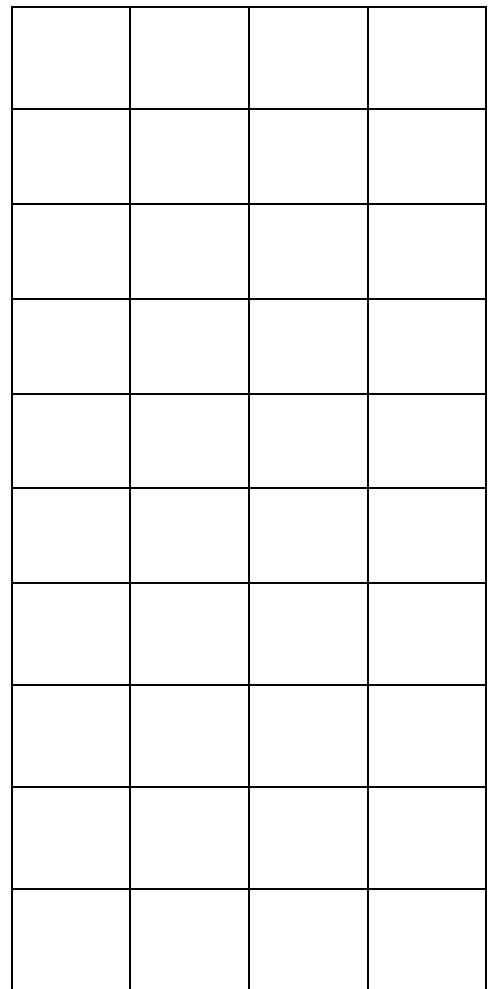
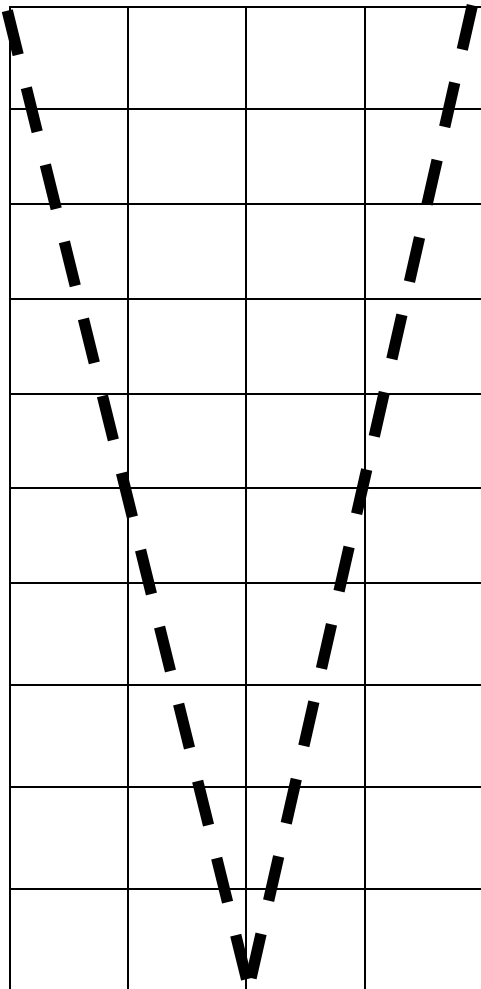
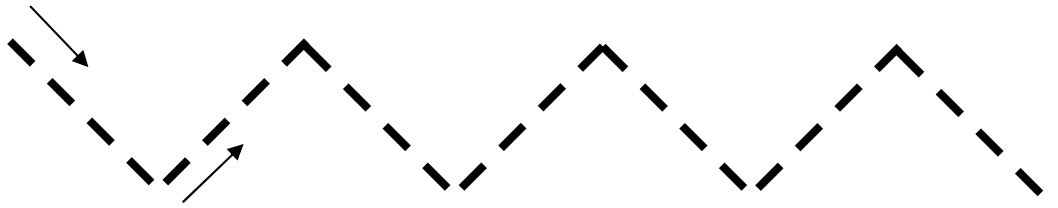
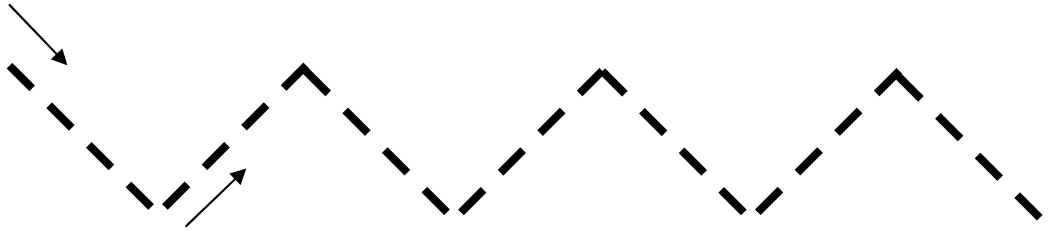

Name _____

Tracing Waves

Follow the lines with your pencil

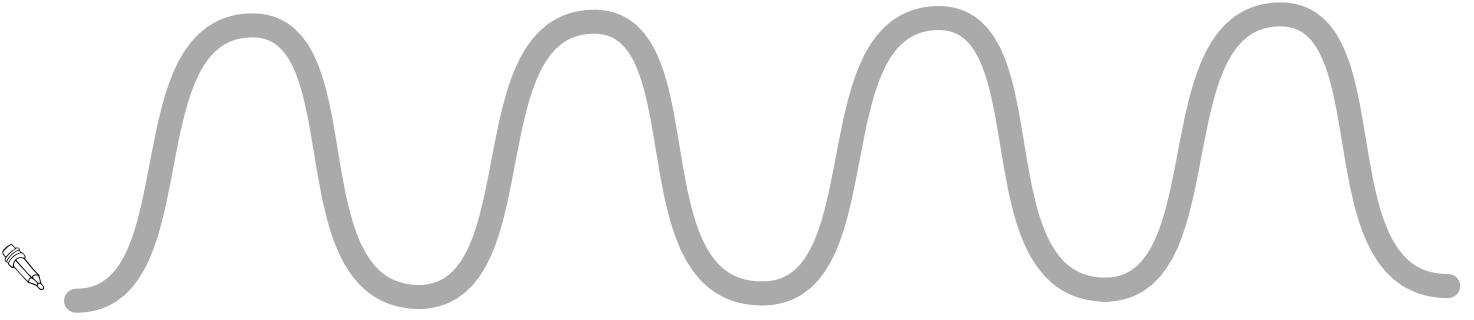
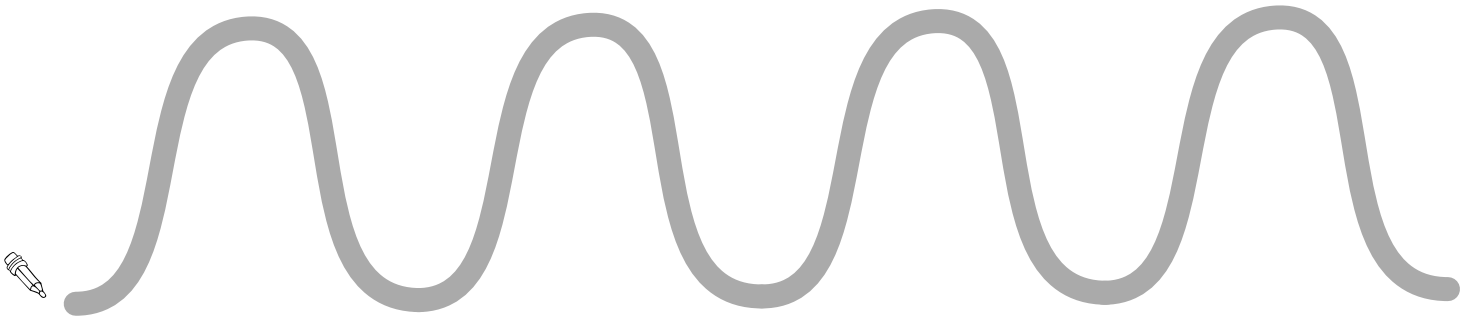

GRAFOMOTRICIDAD

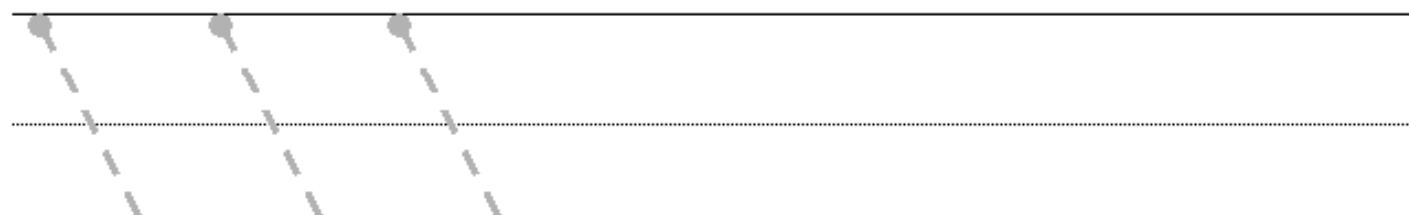
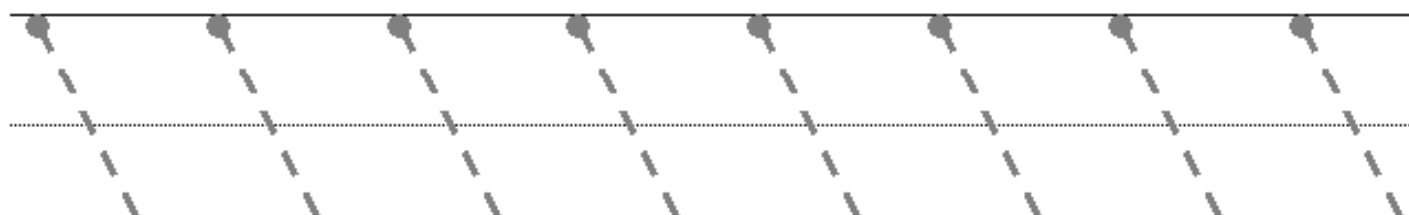
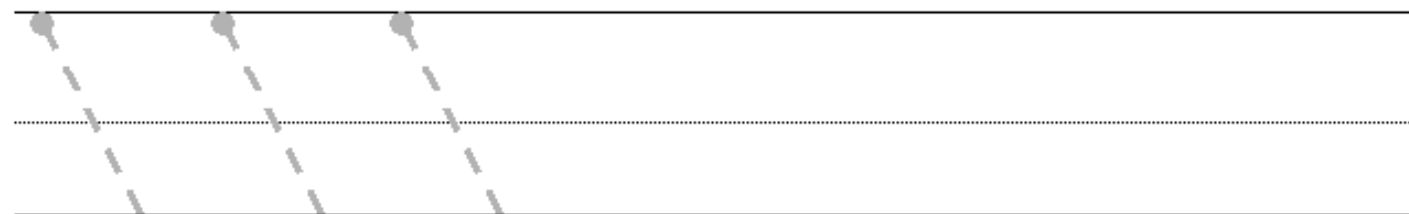
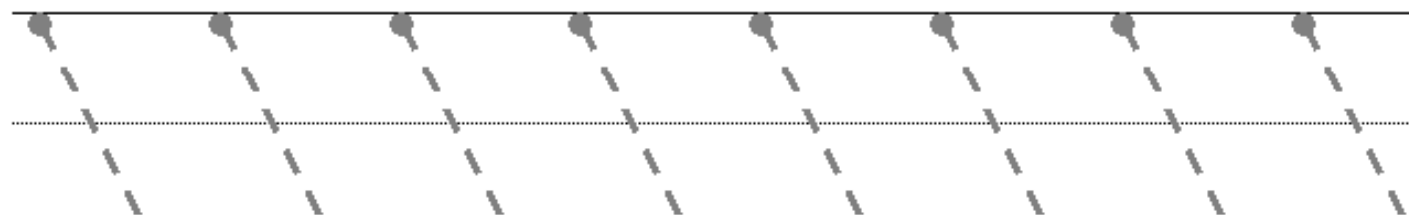
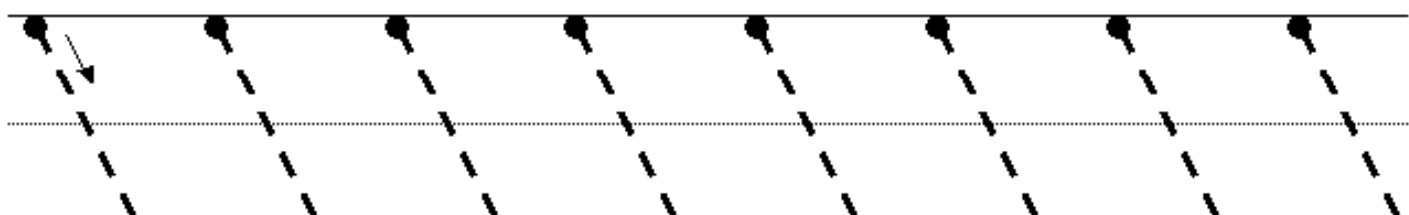
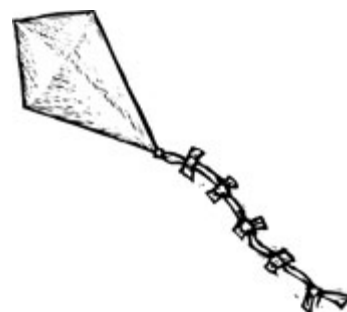
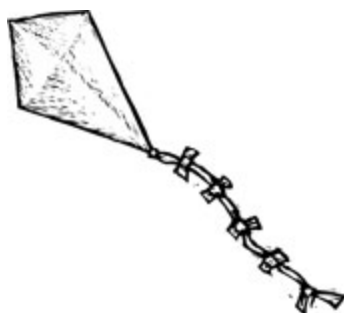
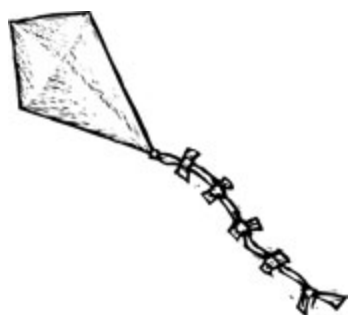

GRAFOMOTRICIDAD

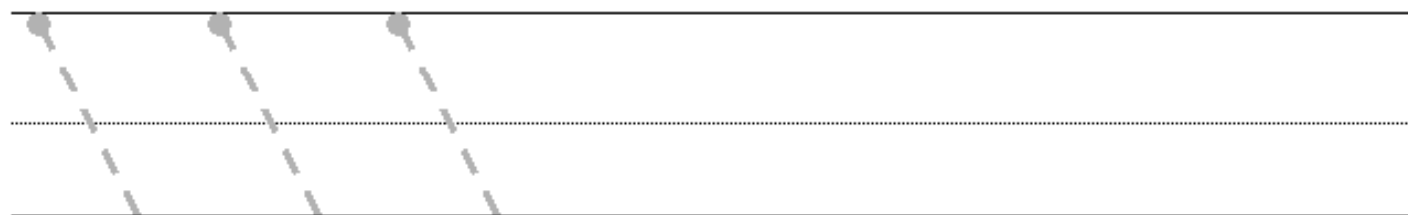
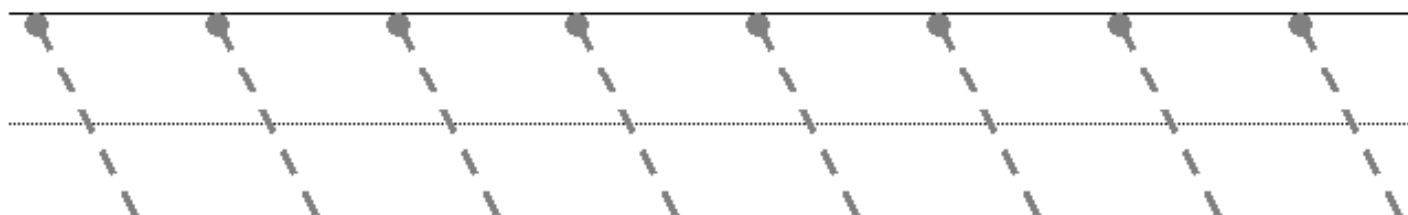
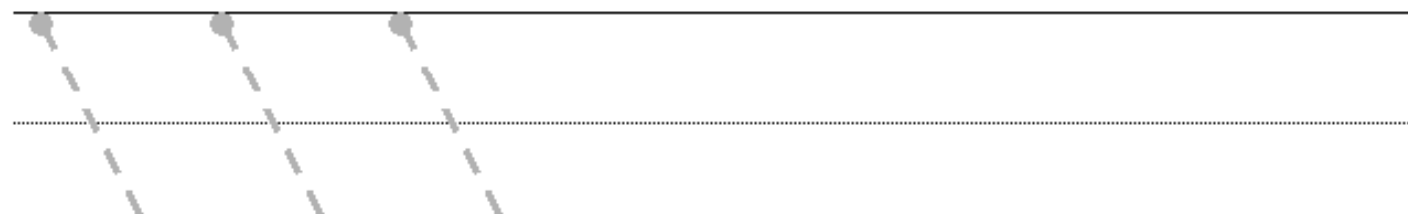
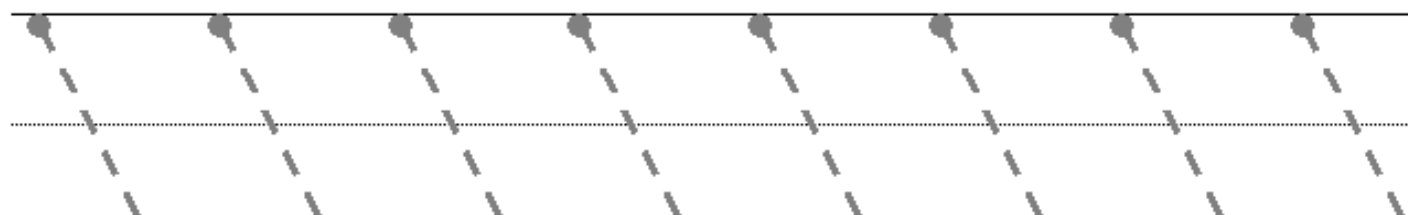
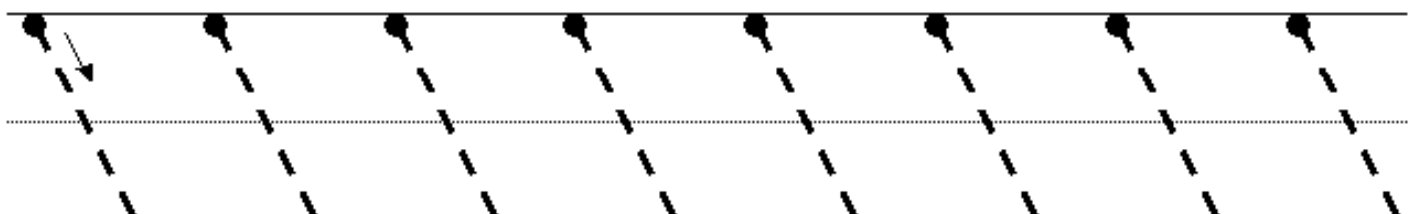
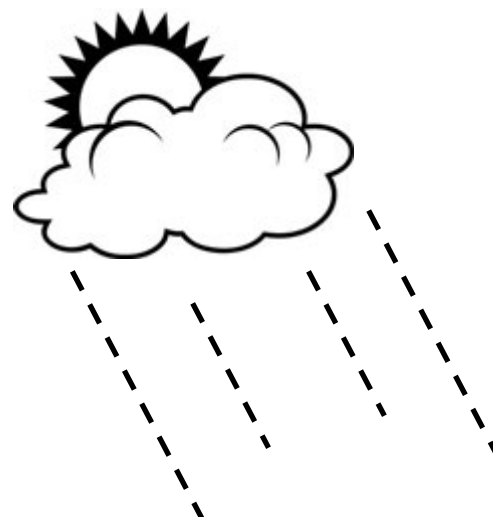
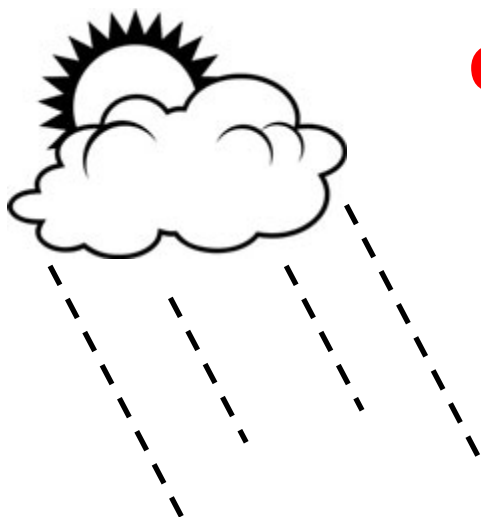

GRAFOMOTRICIDAD

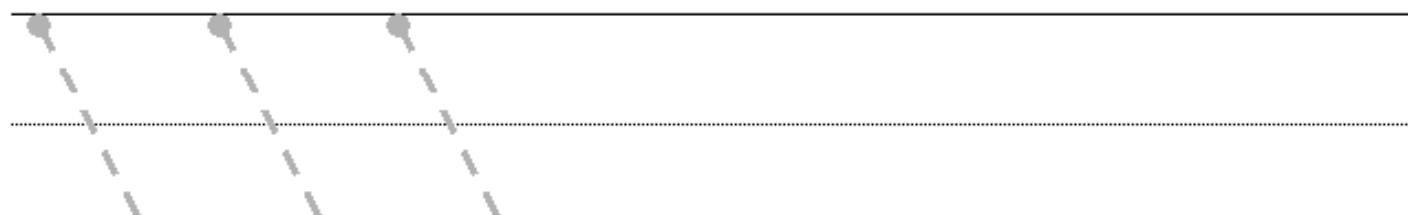
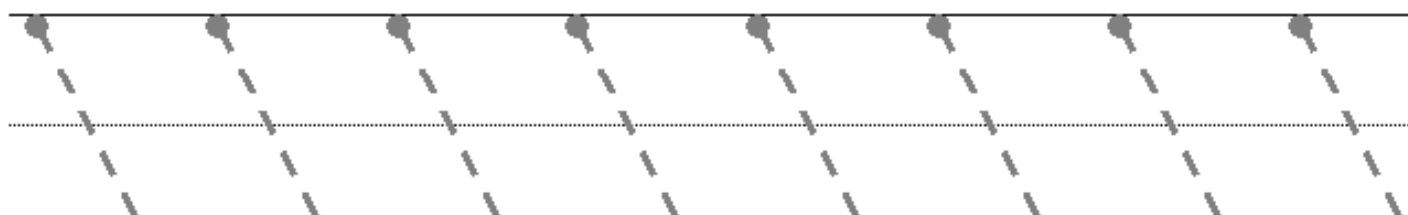
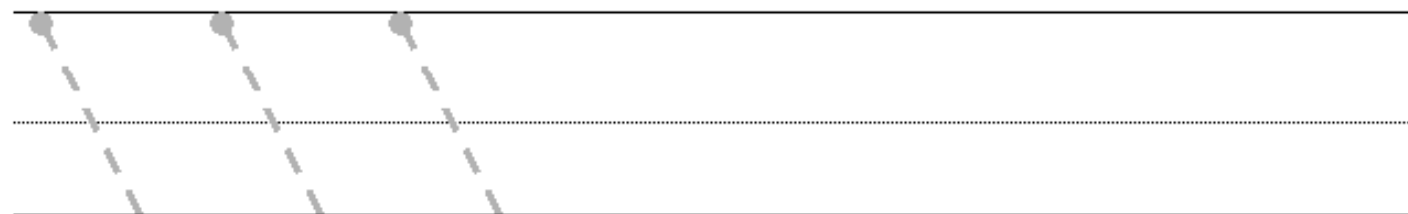
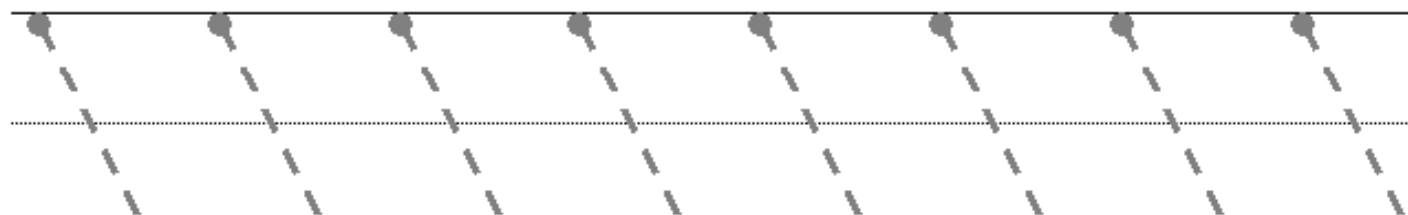
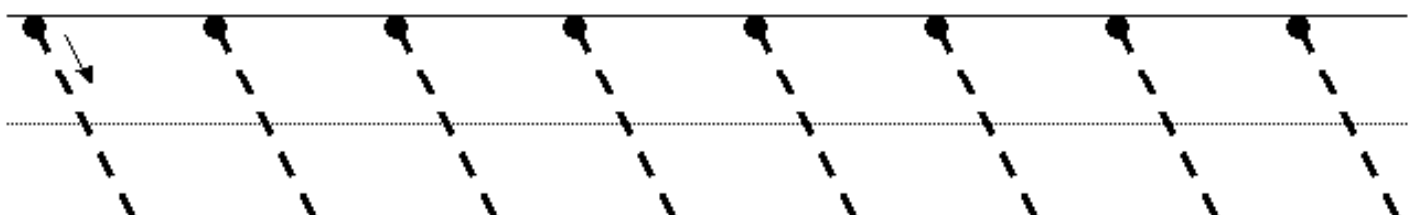
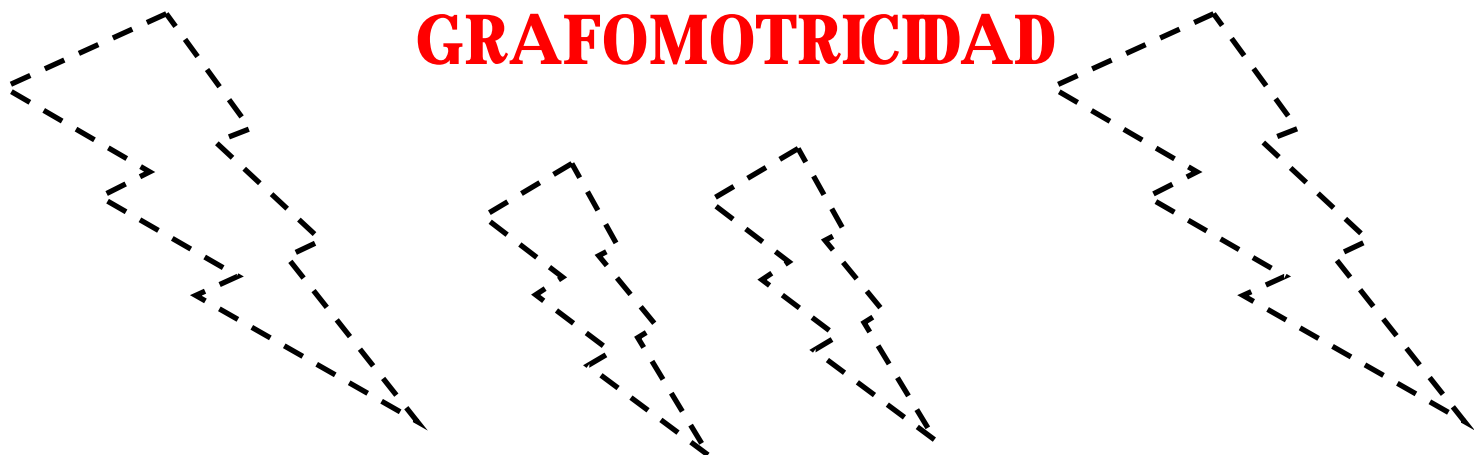

GRAFOMOTRICIDAD

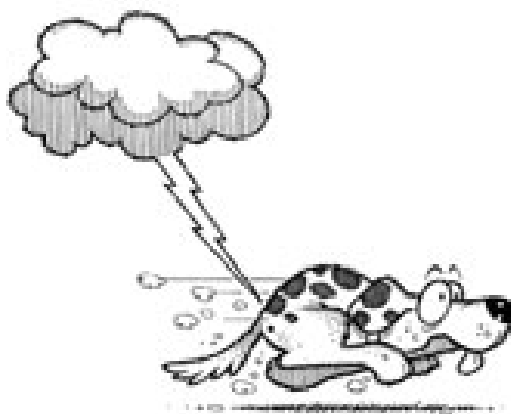

Handwriting practice section consisting of five rows of three-line guides (top solid line, middle dotted line, bottom solid line). Each row contains dashed diagonal lines for tracing, starting from a solid black dot on the top line and ending at the bottom line. The first row includes a small arrow pointing downwards from the first dot to indicate the direction of the stroke. The number of dashed lines per row is: 8, 8, 3, 8, and 3.

Más material en



<https://orientacionandujar.wordpress.com/>

GRAFOMOTRICIDAD

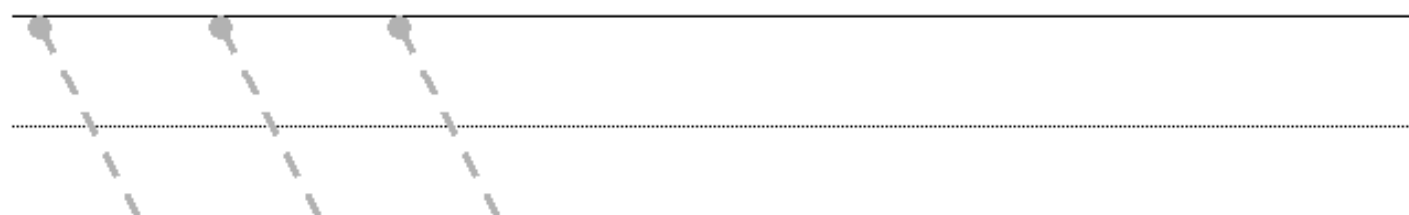
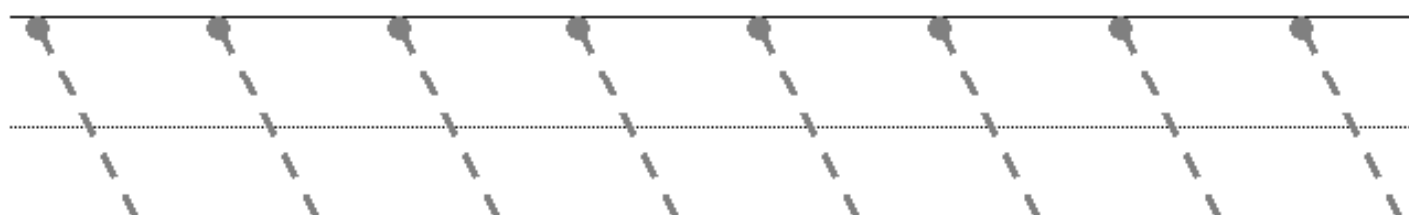
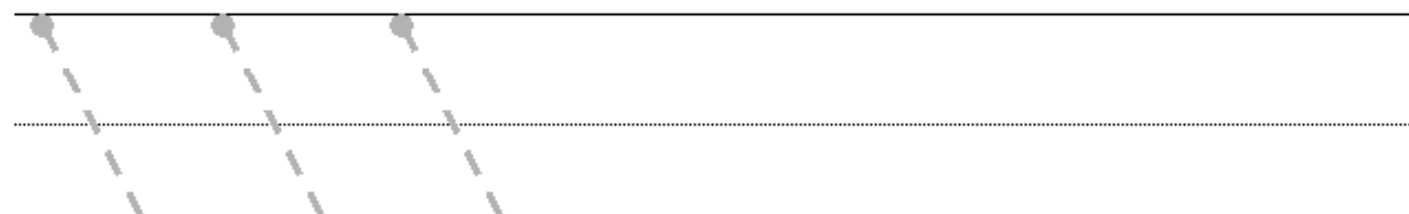
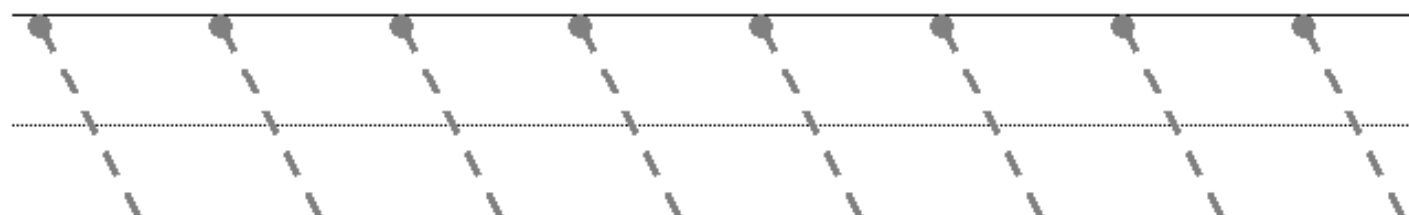
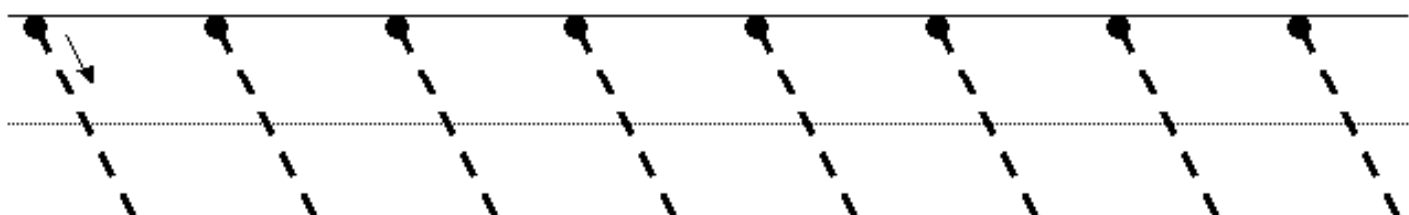

GRAFOMOTRICIDAD

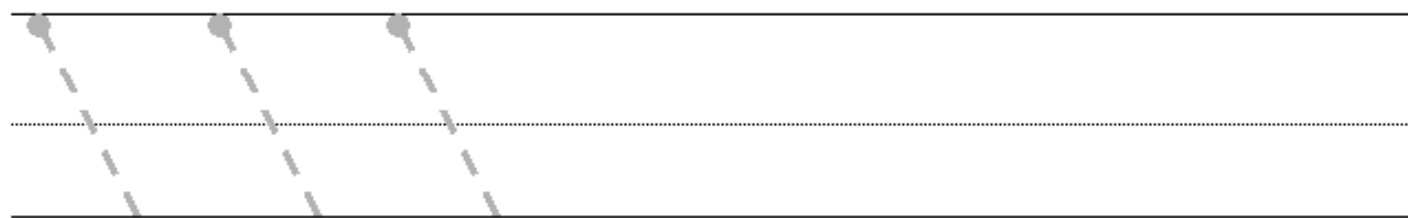
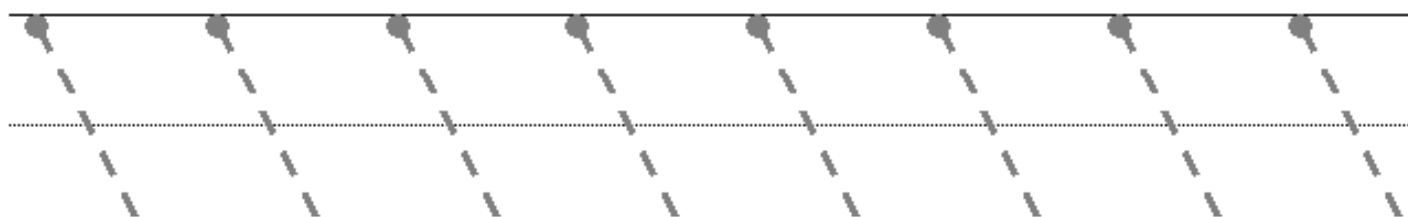
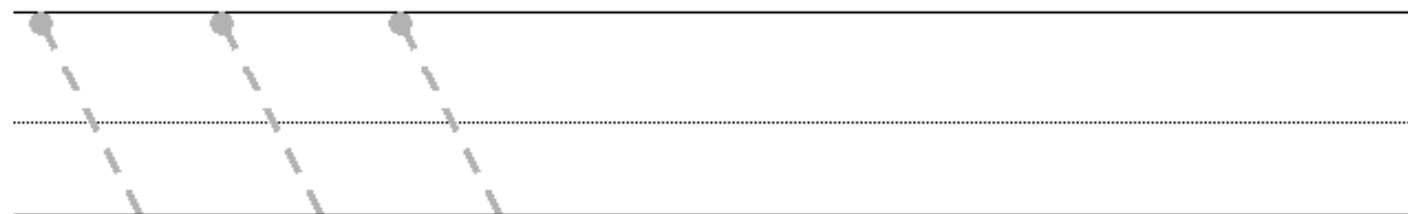
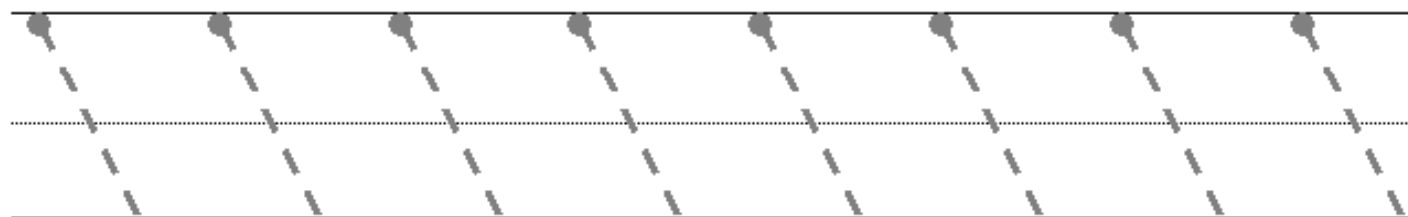
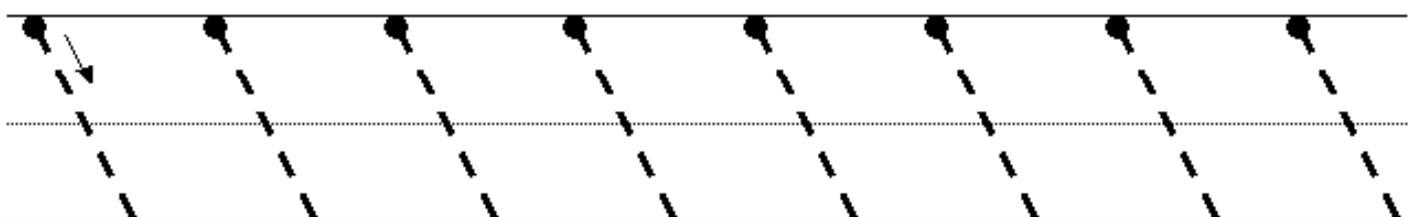

GRAFOMOTRICIDAD

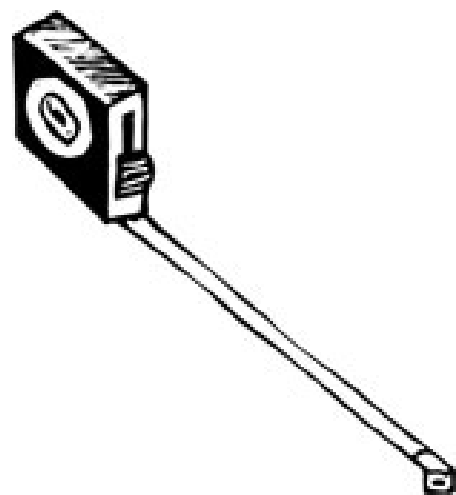
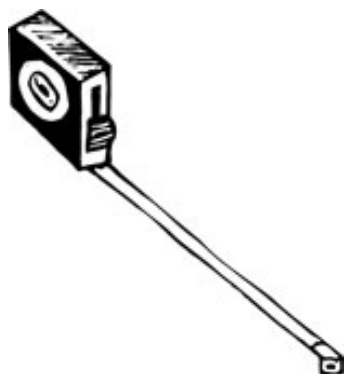
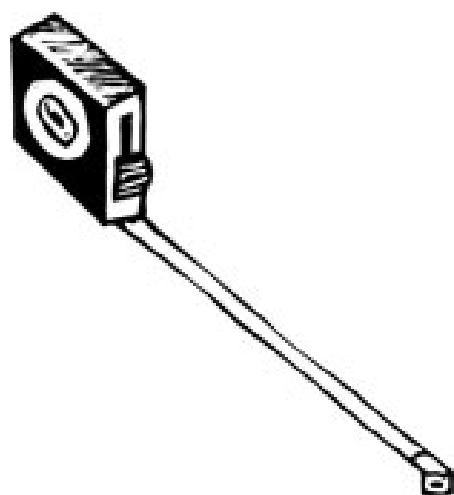

Handwriting practice section consisting of six rows of horizontal lines. Each row has a solid top line, a dotted middle line, and a solid bottom line. The first row contains eight dashed diagonal lines sloping downwards from left to right, each starting with a black dot and an arrow indicating the direction of the stroke. The second row contains eight dashed diagonal lines sloping downwards from left to right, each starting with a grey dot. The third row contains three dashed diagonal lines sloping downwards from left to right, each starting with a grey dot. The fourth row contains eight dashed diagonal lines sloping downwards from left to right, each starting with a black dot. The fifth row contains three dashed diagonal lines sloping downwards from left to right, each starting with a grey dot. The sixth row contains three dashed diagonal lines sloping downwards from left to right, each starting with a grey dot.



GRAFOMOTRICIDAD

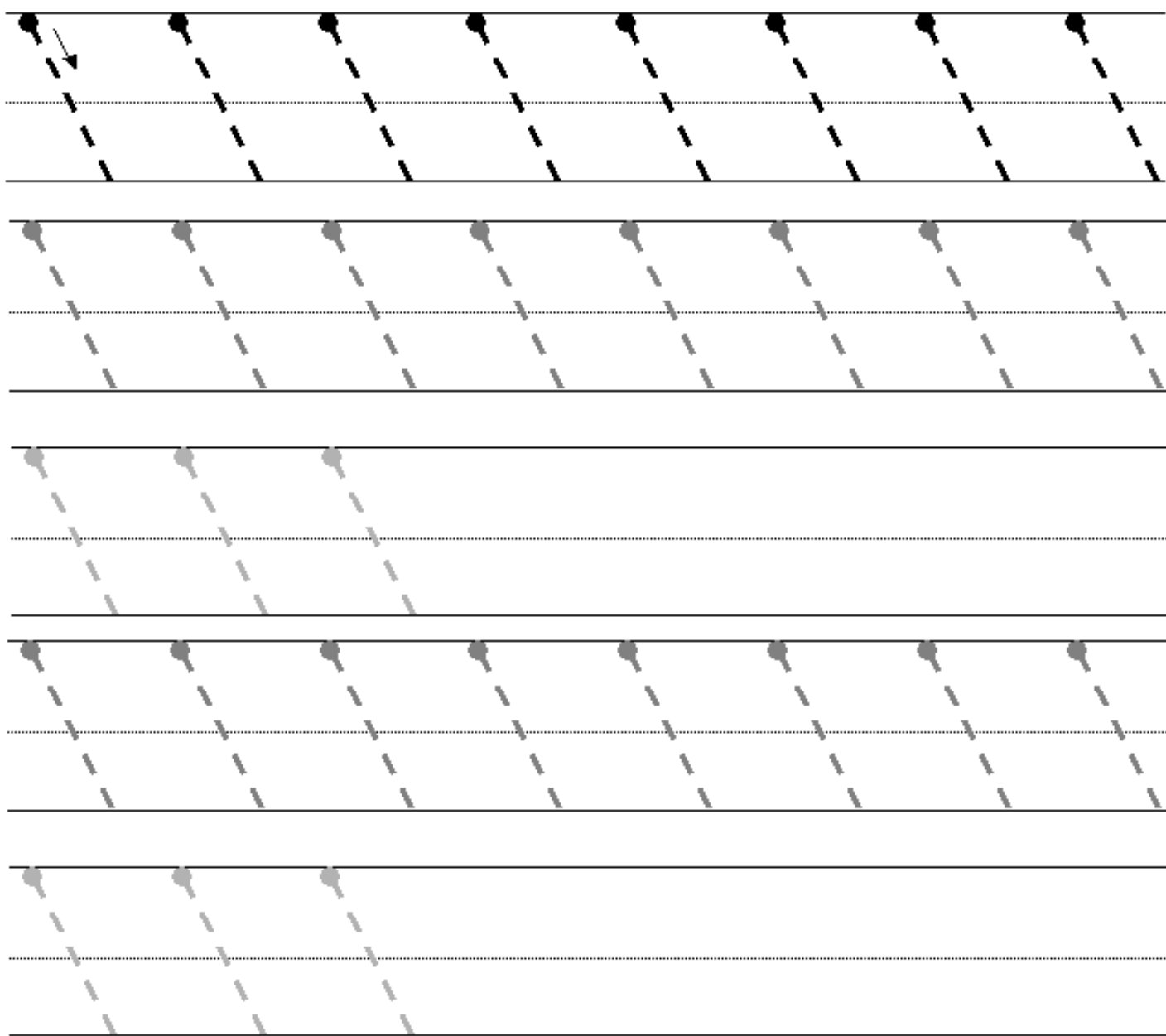

GRAFOMOTRICIDAD

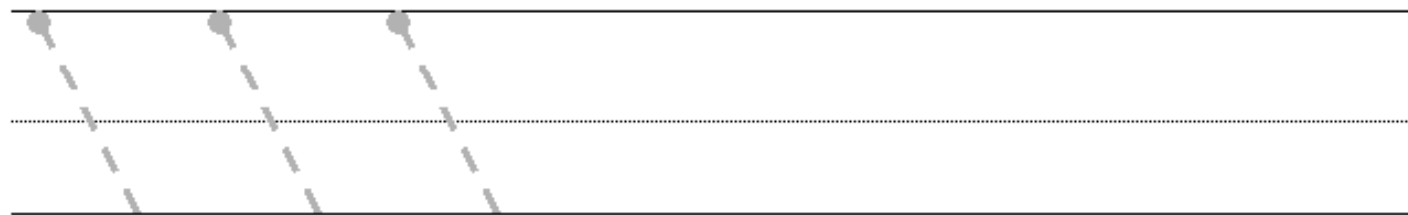
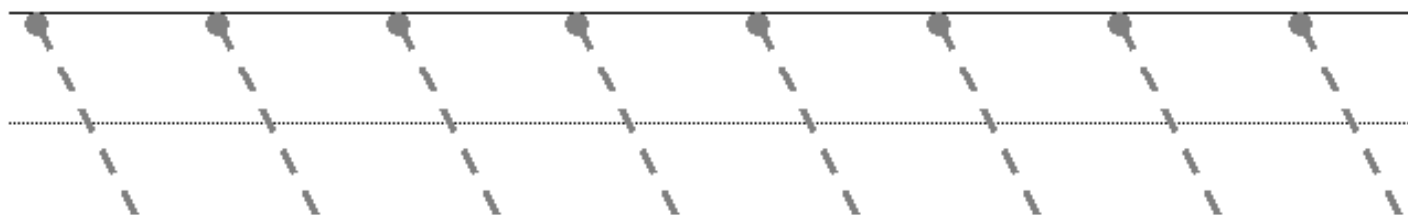
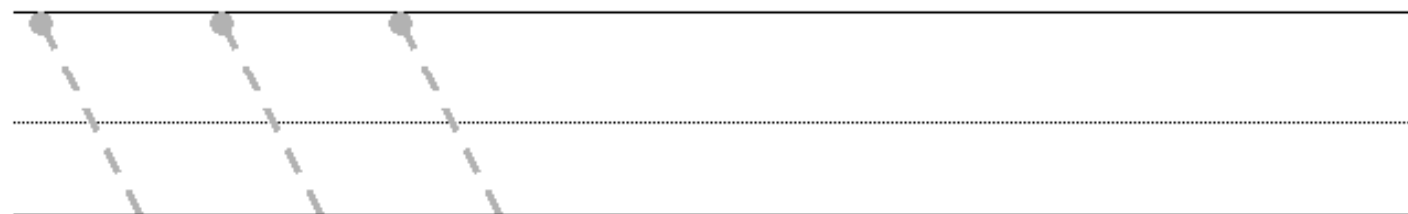
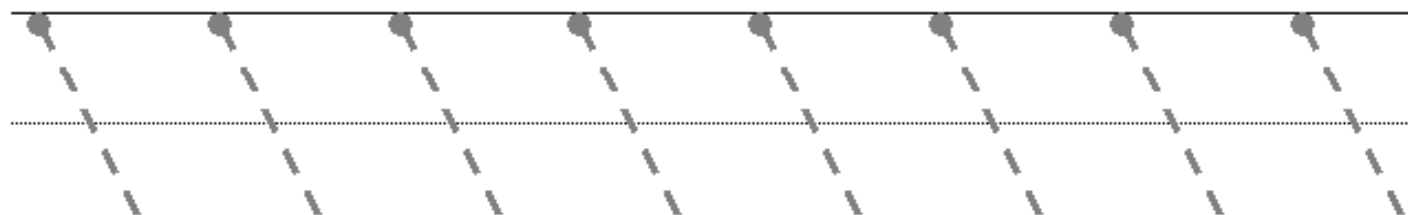
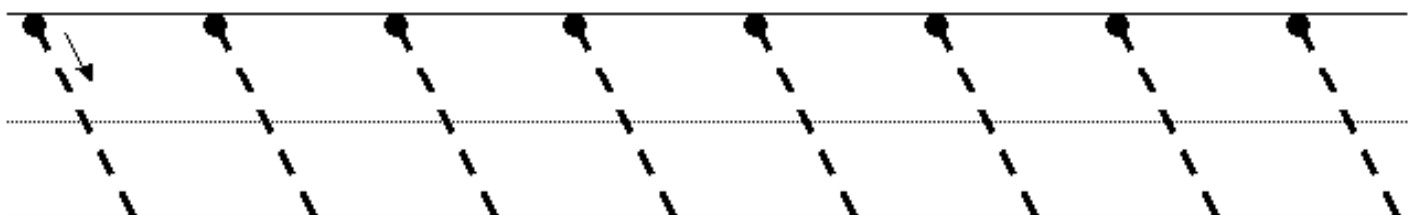

GRAFOMOTRICIDAD

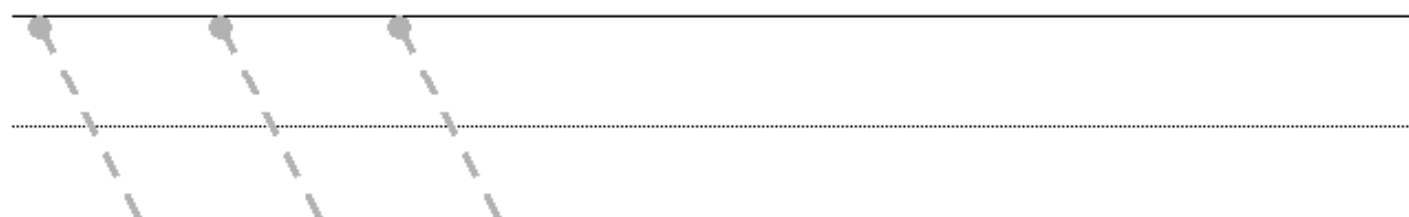
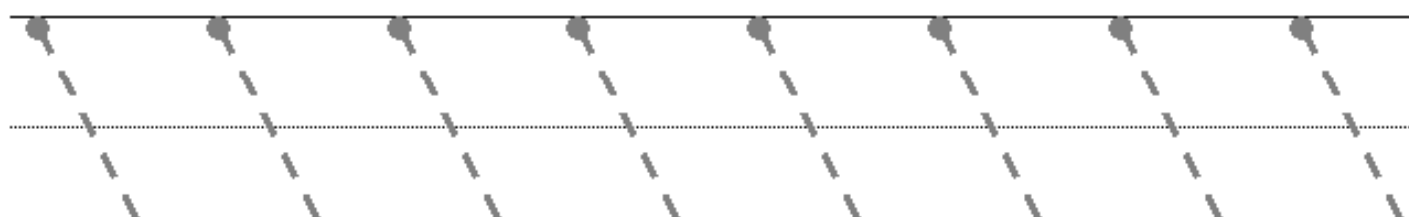
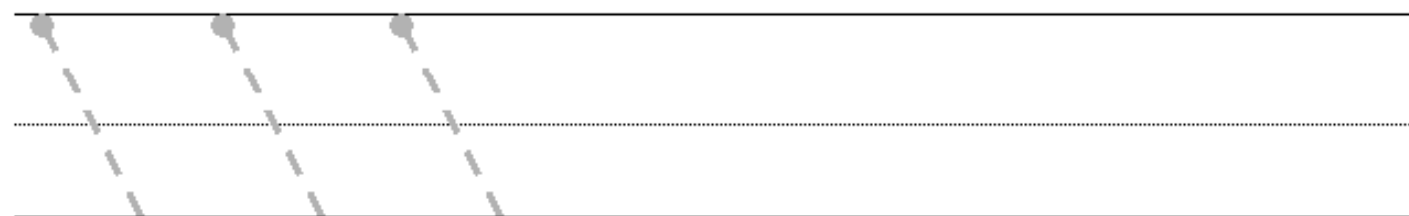
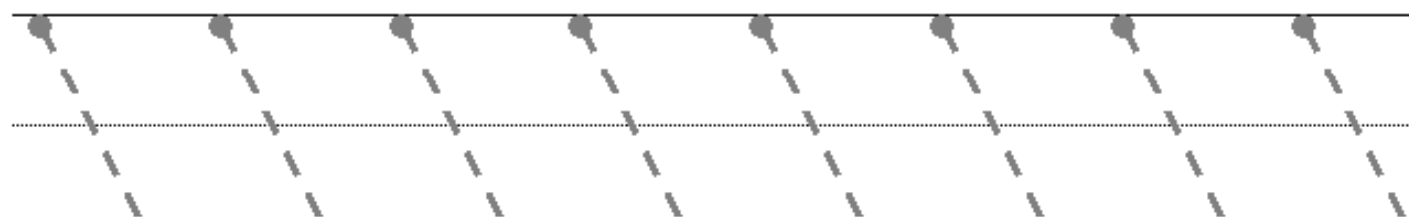
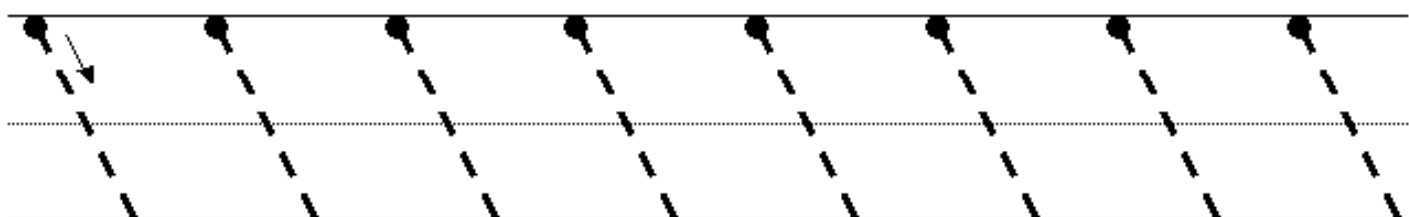

GRAFOMOTRICIDAD

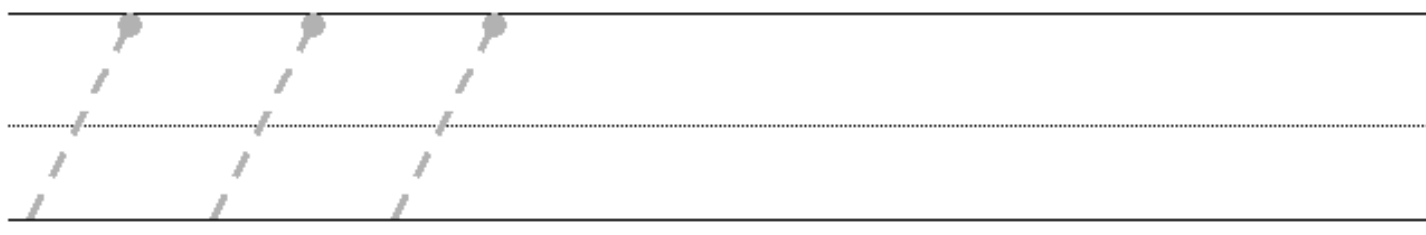
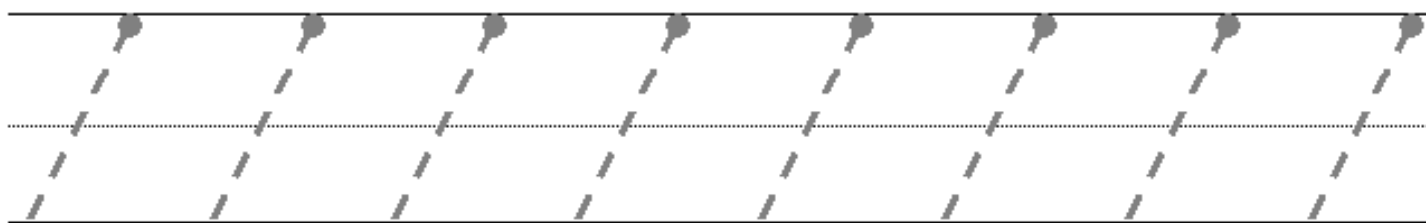
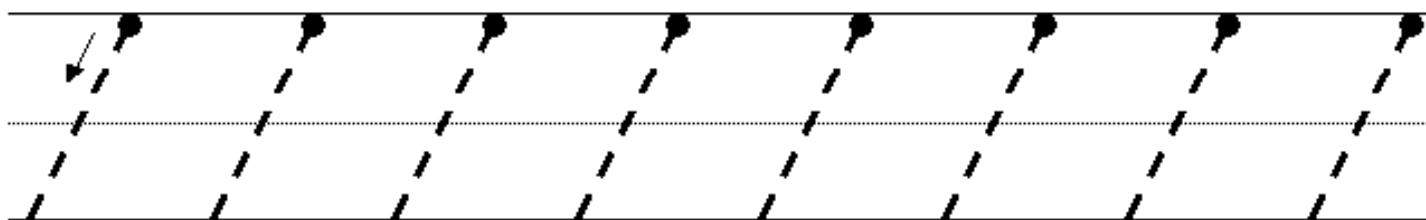
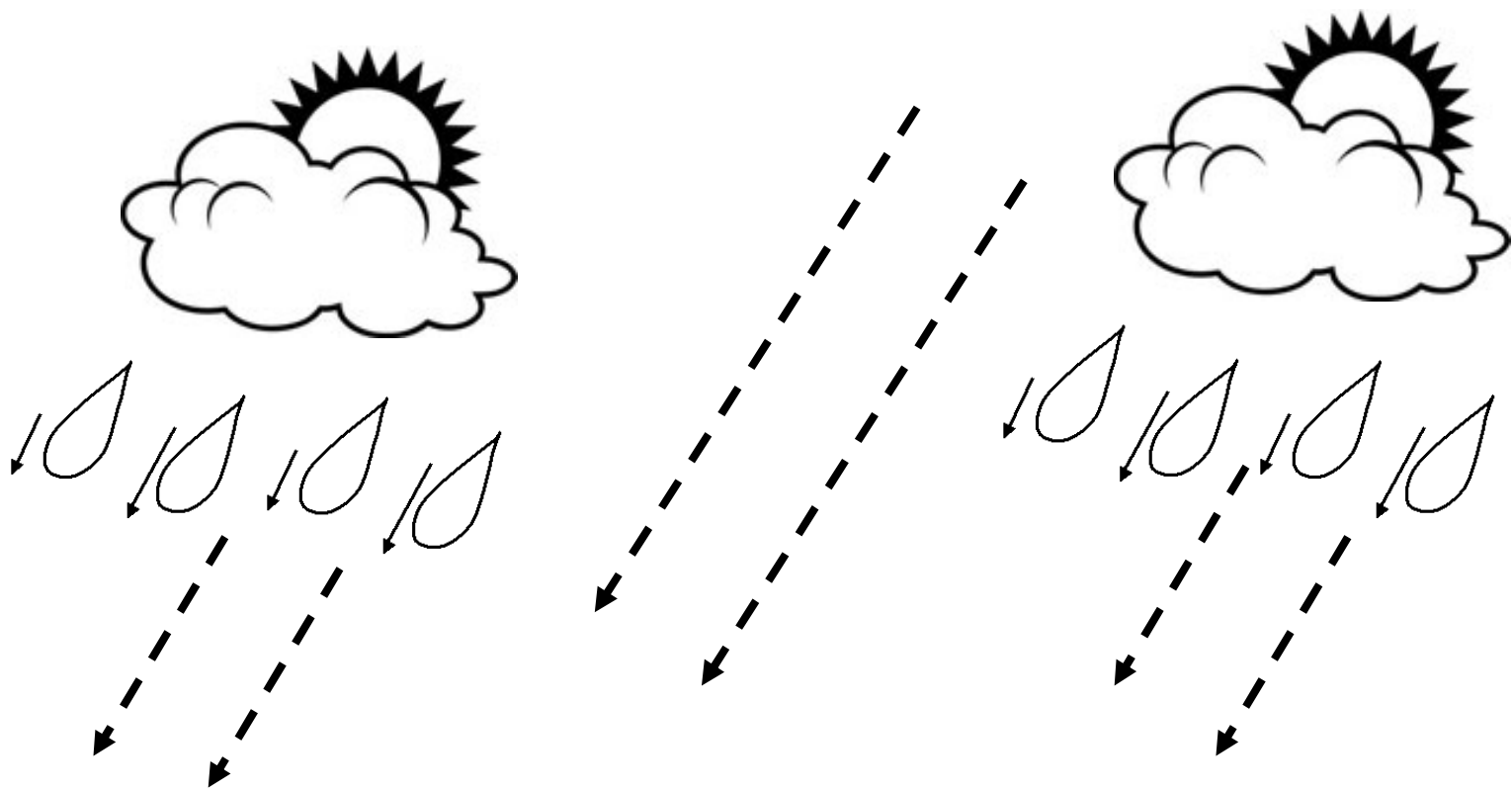

GRAFOMOTRICIDAD

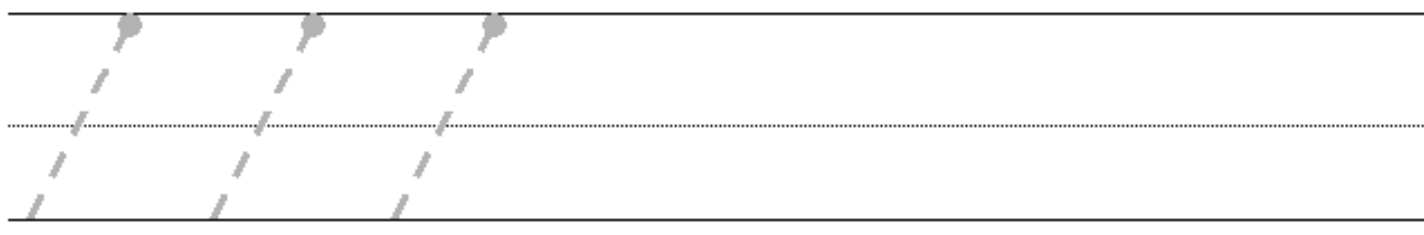
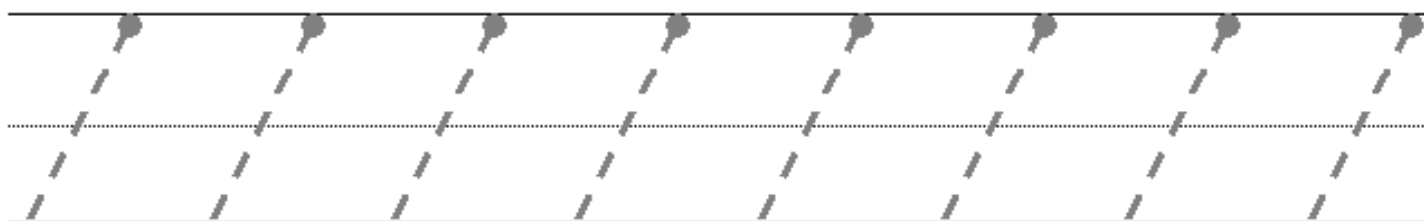
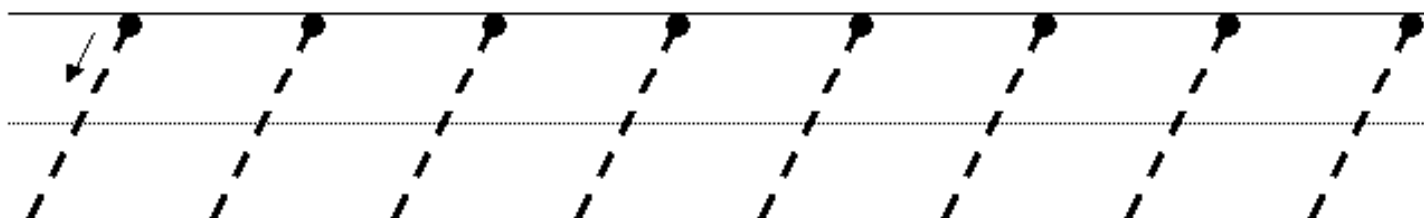
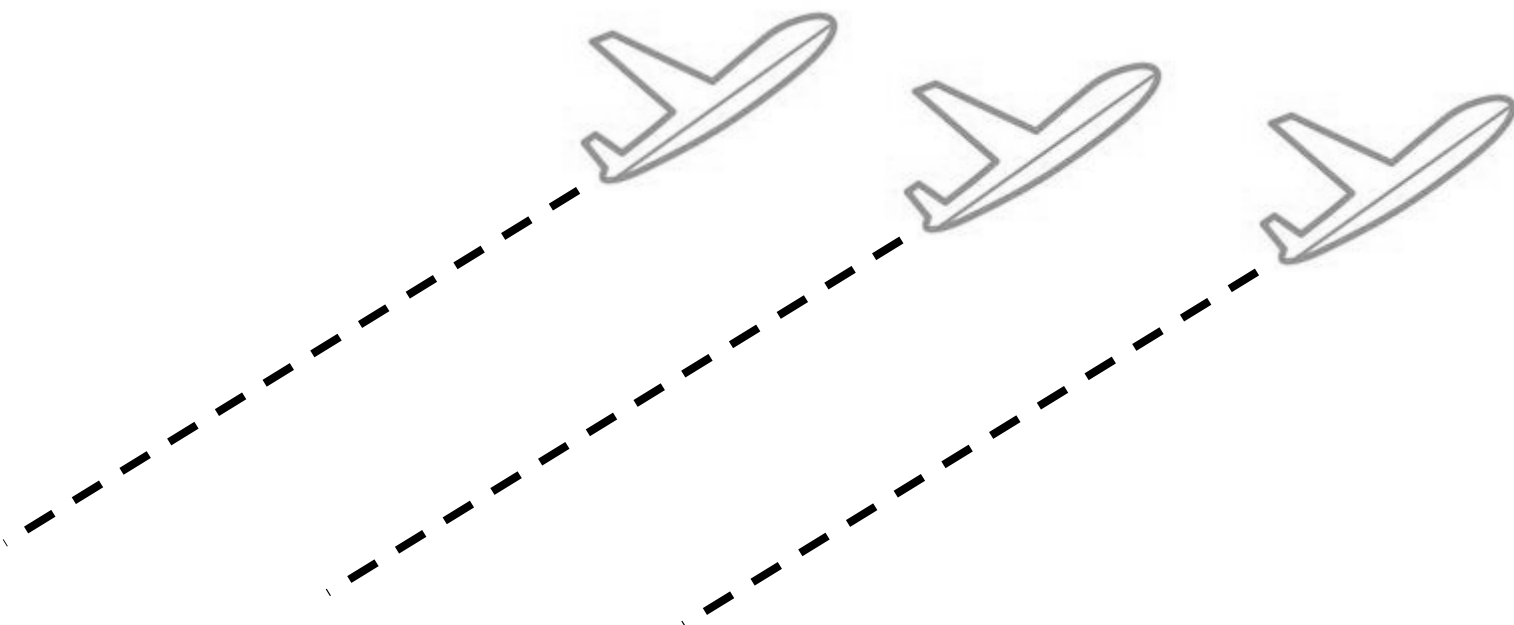

GRAFOMOTRICIDAD

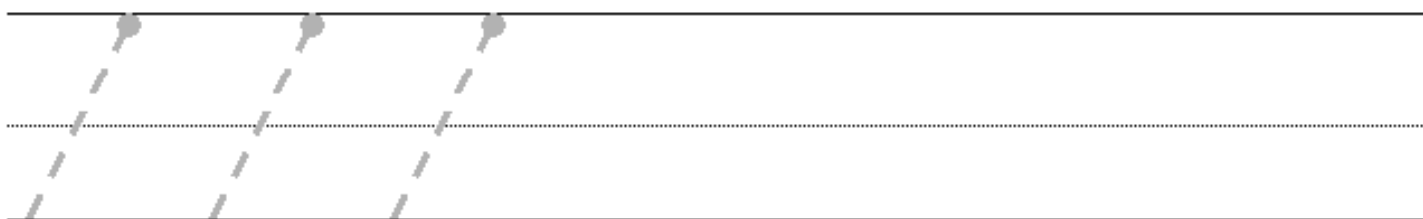
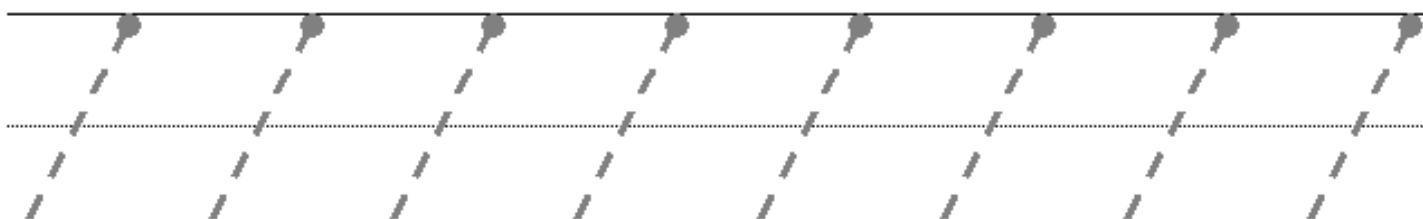
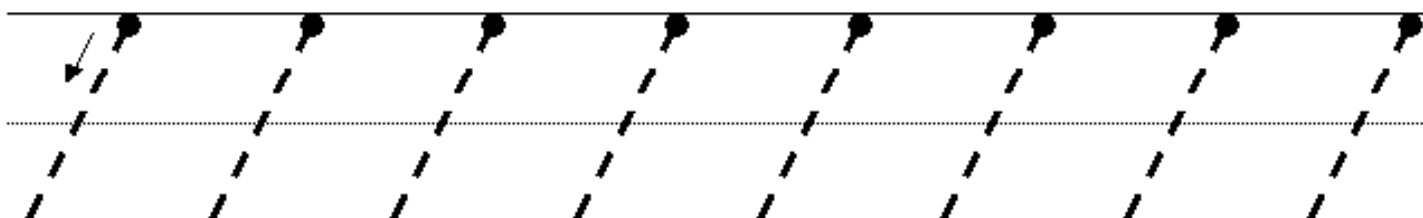
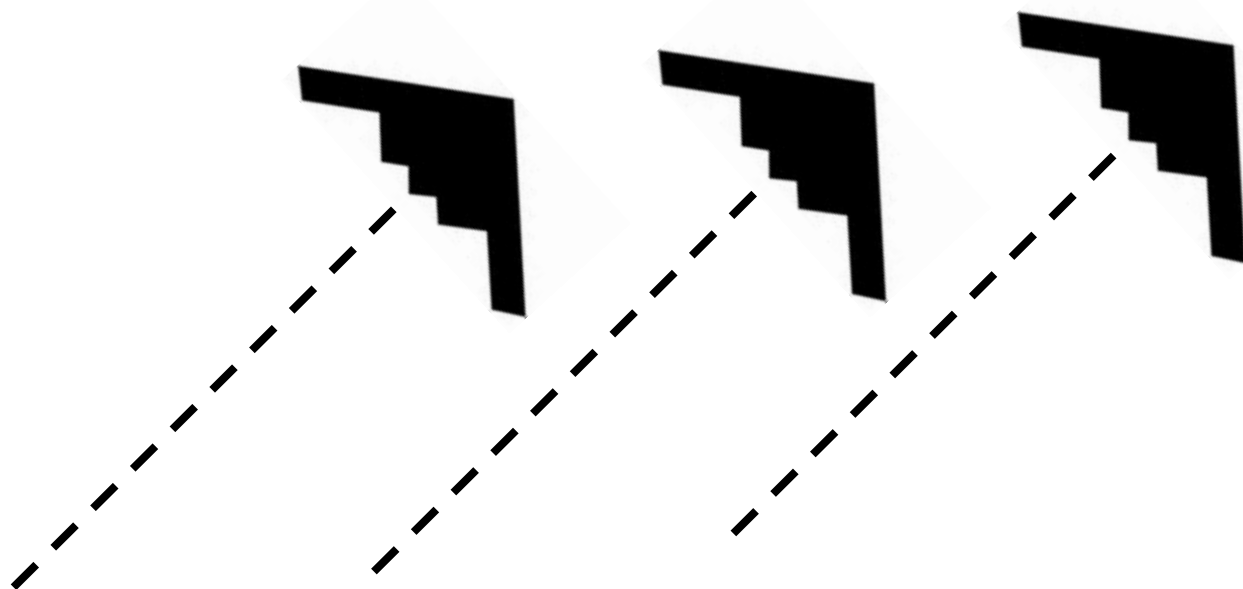

Más material en



<https://orientacionandujar.wordpress.com/>

GRAFOMOTRICIDAD

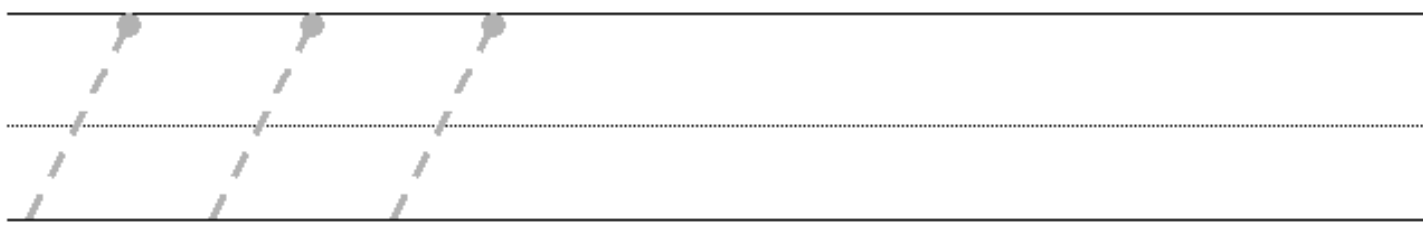
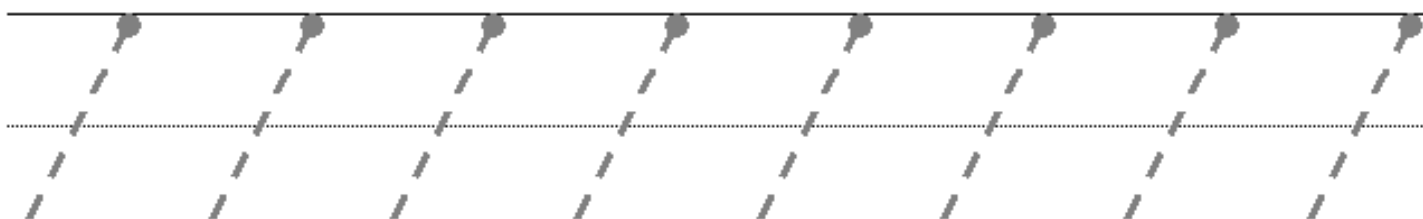
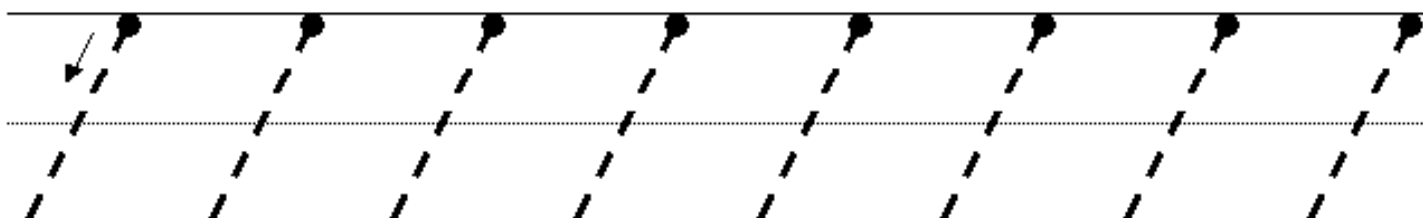
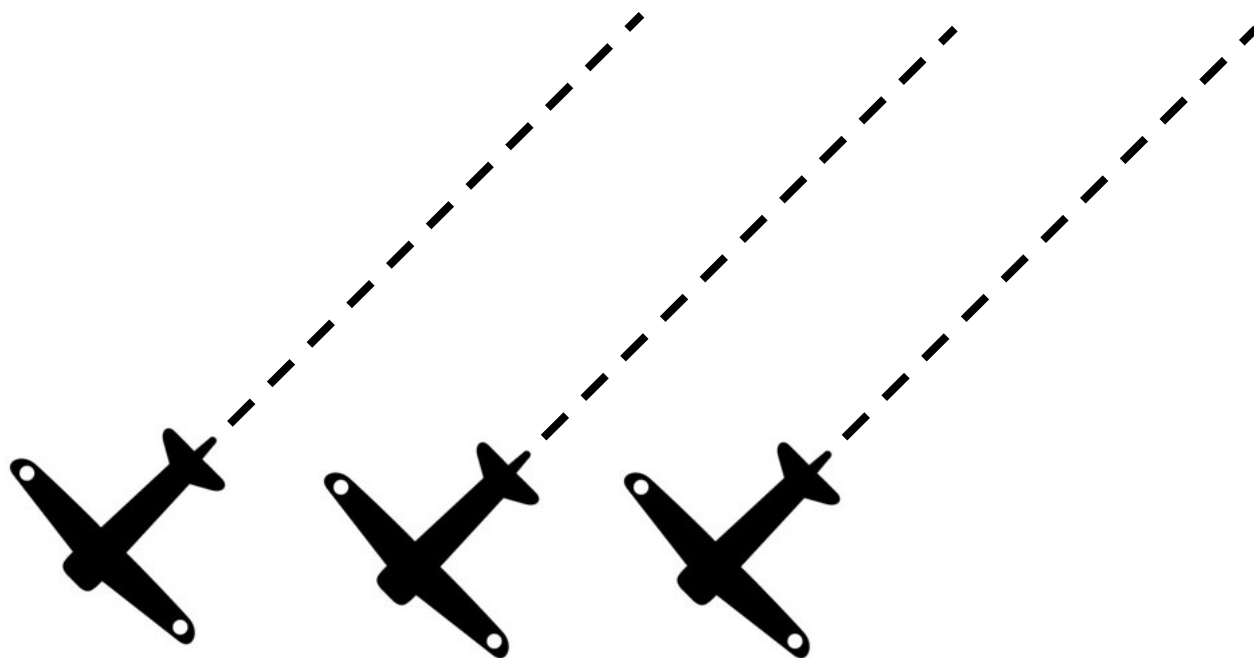

Más material en



<https://orientacionandujar.wordpress.com/>

GRAFOMOTRICIDAD

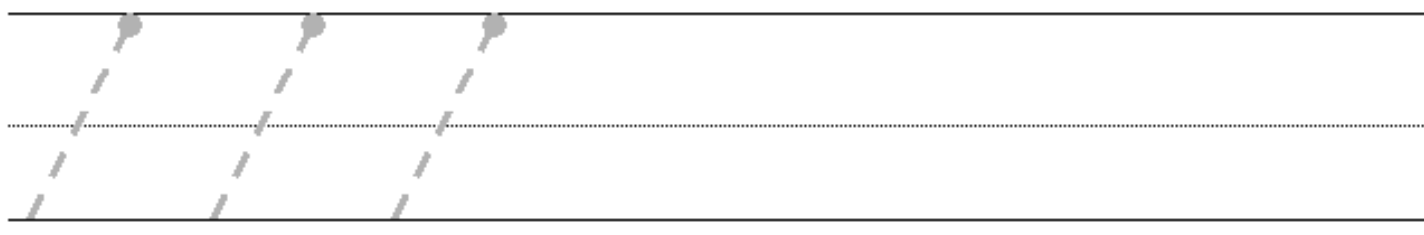
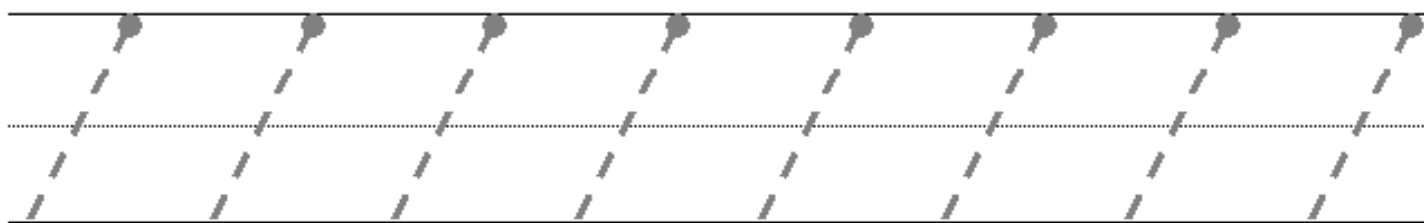
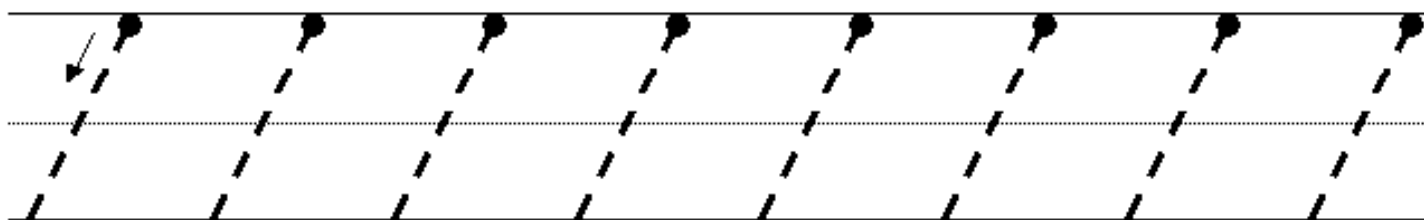
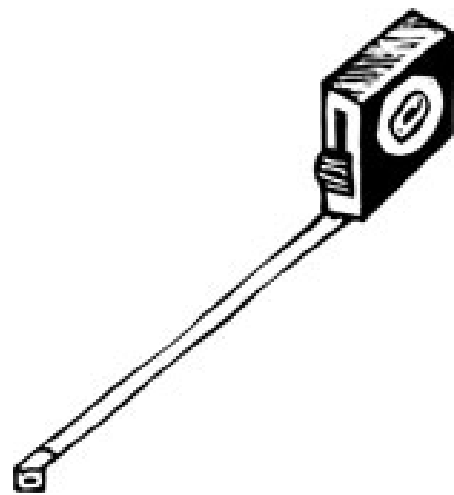
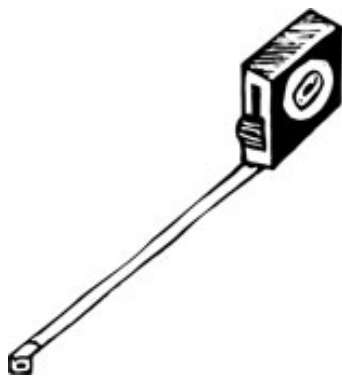
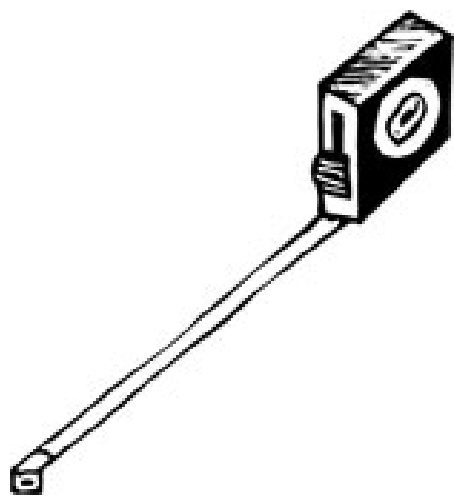

Más material en



<https://orientacionandujar.wordpress.com/>

GRAFOMOTRICIDAD

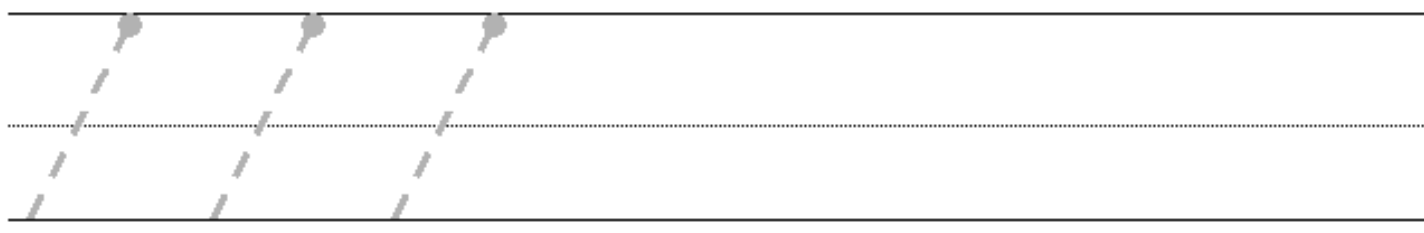
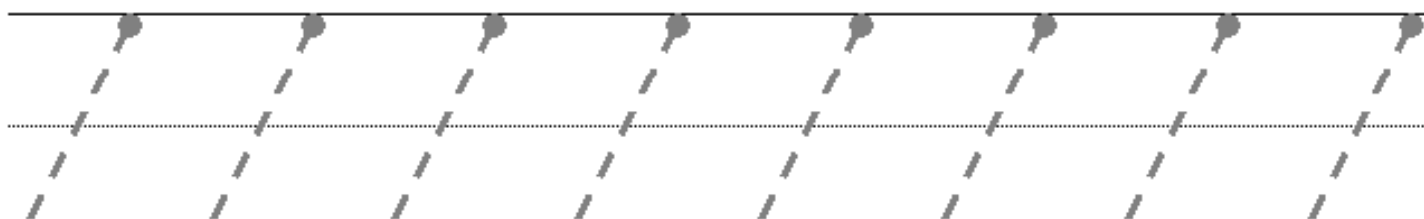
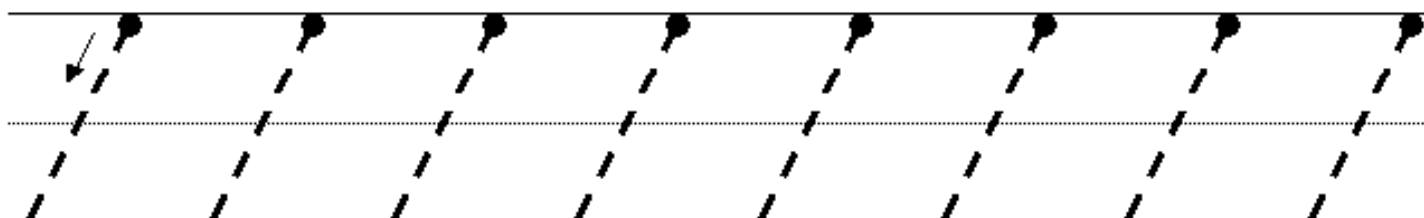

Más material en



<https://orientacionandujar.wordpress.com/>

GRAFOMOTRICIDAD

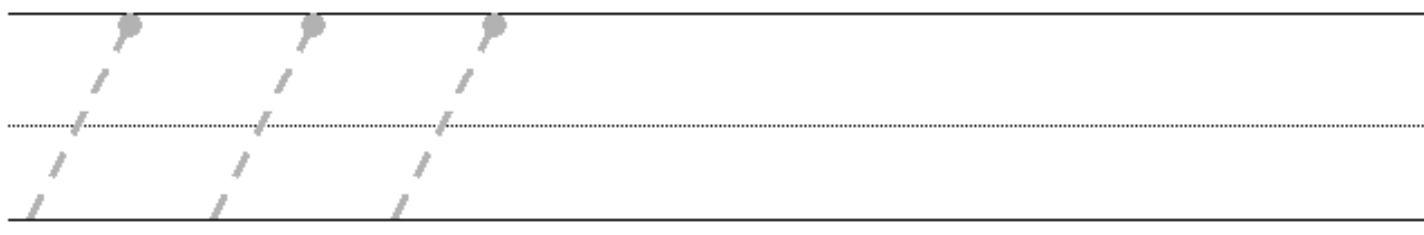
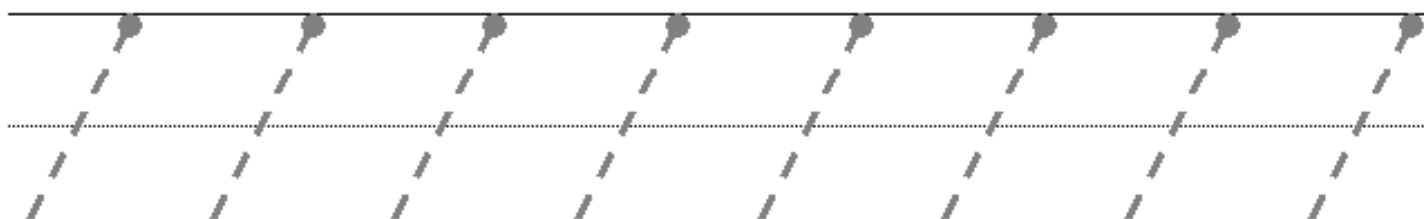
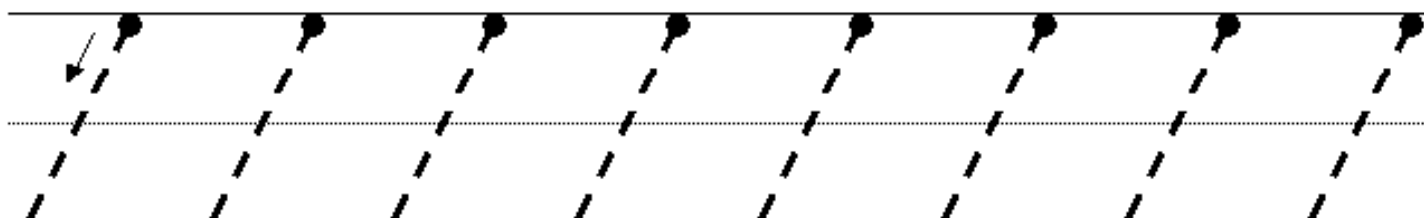

Más material en



<https://orientacionandujar.wordpress.com/>

GRAFOMOTRICIDAD

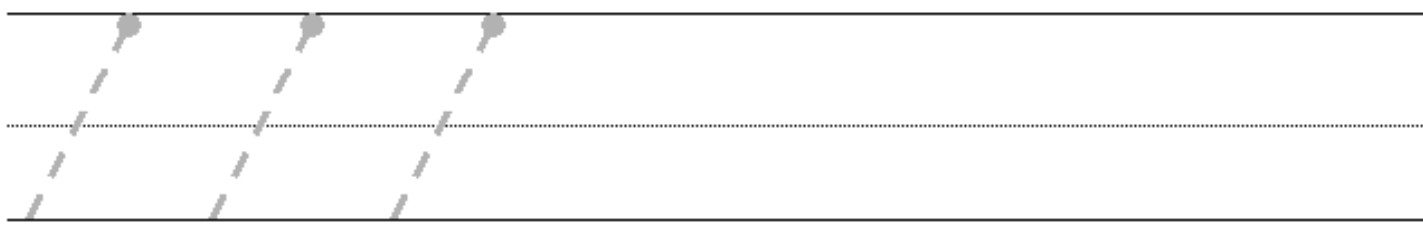
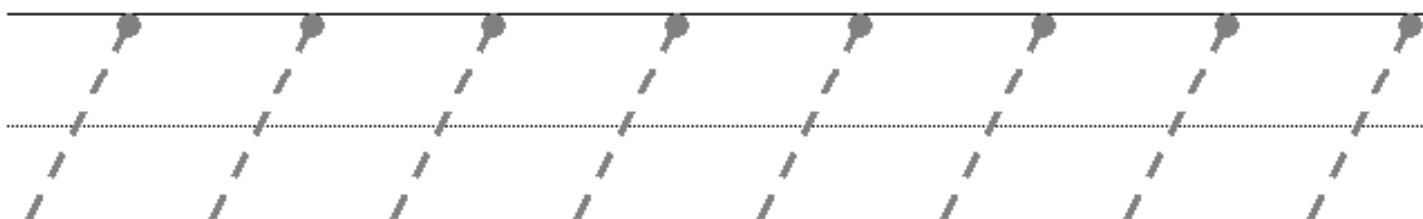
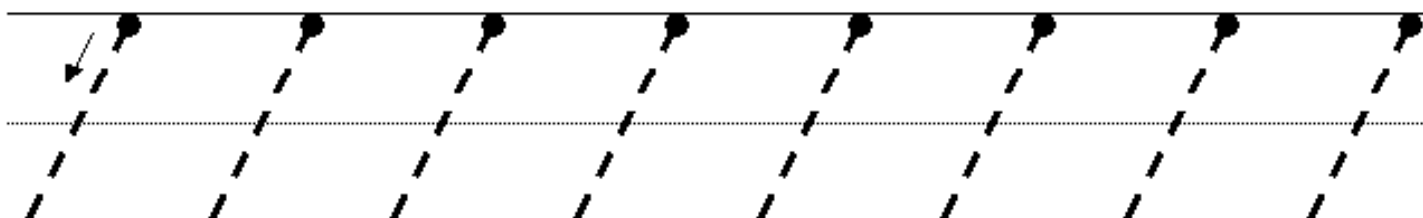
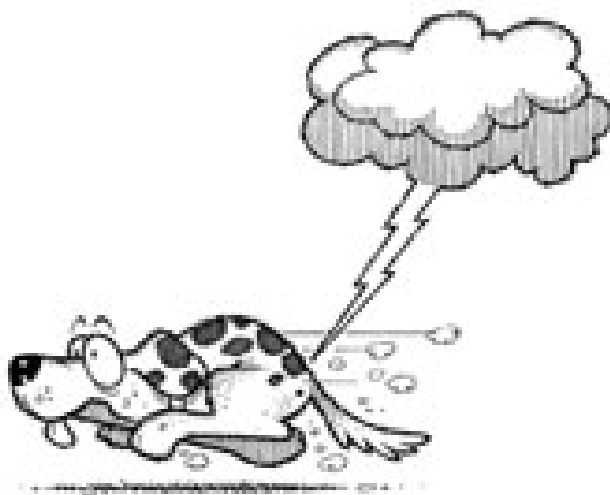

Más material en



<https://orientacionandujar.wordpress.com/>

GRAFOMOTRICIDAD

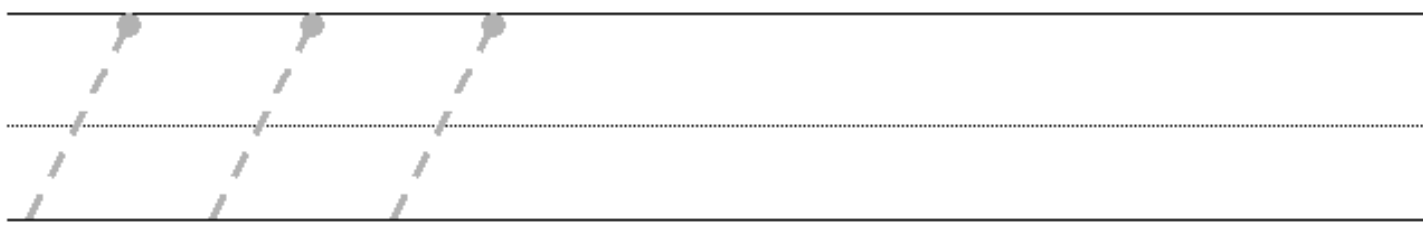
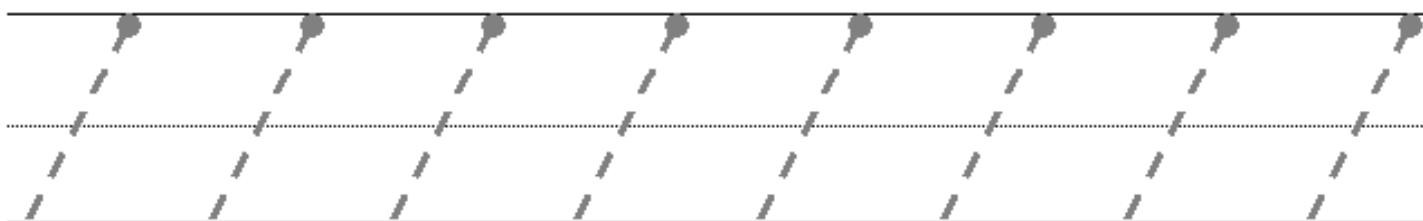
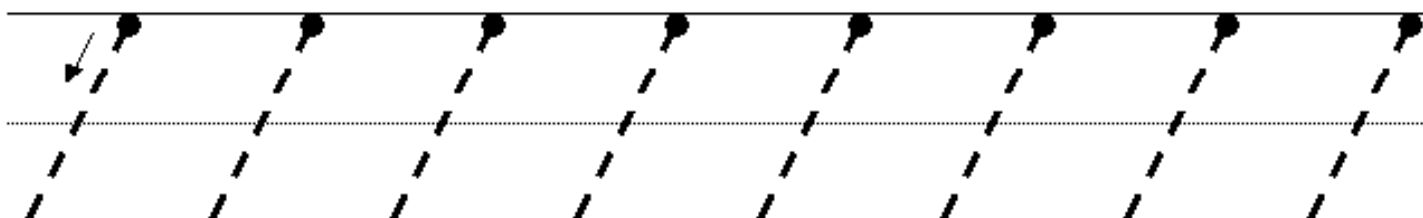
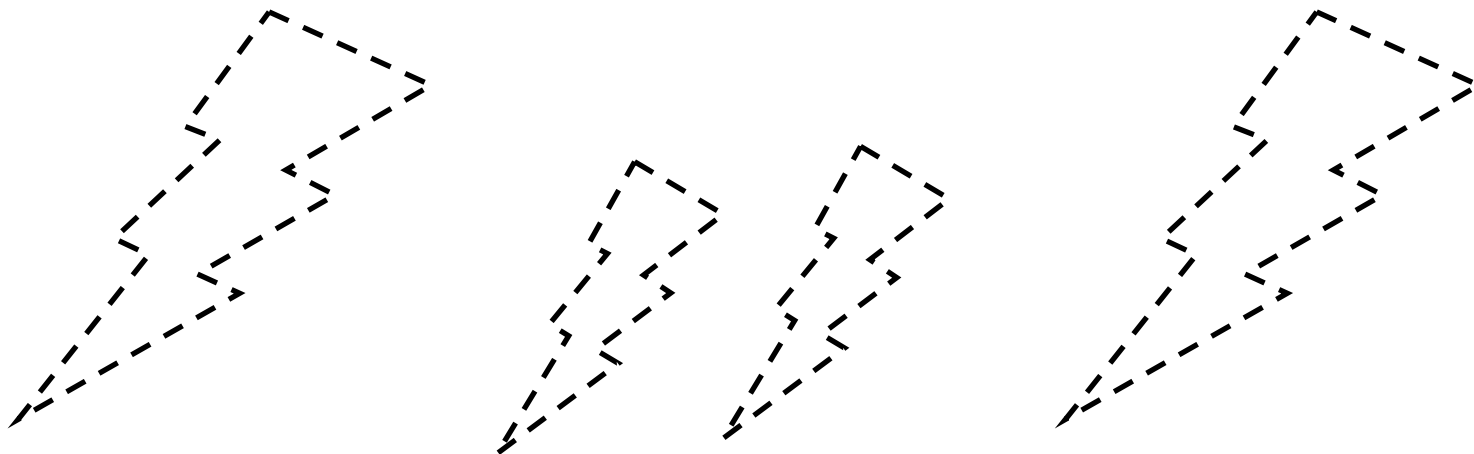

Más material en



<https://orientacionandujar.wordpress.com/>

GRAFOMOTRICIDAD

