





Nombre..... Fecha.....

Lleva a la mariposa con la mariquita siguiendo solo las letras "m".

			m	m	m	m	m	m	m
			a	s	r	y	h	j	m
			s	t	t	t	t	t	m
a	s	d	f	t	g	h	k	l	m
a	s	w	e	r	y	j	j	k	m
t	m	m	m	m	m	m	m	m	m
r	m	t	y	a	d	f	j	f	g
ñ	m	w	h	t	r	i	t	g	h
e	m	z	t	m	m	m	m	j	k
d	m	d	q	m	r	t			
k	m	s	d	m	i	y			
j	m	m	m	m	p	u			



Nombre..... Fecha.....

Lleva a la mariposa con la mariquita siguiendo solo las letras "M".

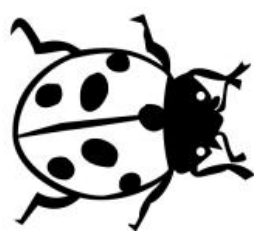

			P	M	M	M	Q	W	R
			L	M	K	M	C	T	T
			Ñ	M	L	M	V	V	V
M	W	M	I	M	Ñ	B	B	H	B
M	D	M	M	M	Q	M	P	X	N
M	F	M	A	Y	S	M	Q	W	J
M	G	M	S	M	M	M	G	G	L
M	H	M	Z	M	A	S	D	F	P
M	Y	M	X	M	R	T	Y	U	Ñ
M	U	M	T	M	Y	T			
M	I	M	U	M	M	M			
M	M	M	P	Ñ	O	L			



Nombre..... Fecha.....

Lleva al mecánico con su moto siguiendo solo las letras "m".

			m	m	m	a	m	m	m
			m	s	m	f	m	h	m
			m	l	m	k	m	j	m
z	x	c	v	b	m	l	m	ñ	m
m	m	m	m	m	m	u	m	p	m
m	t	y	u	i	o	p	m	l	m
m	a	m	m	m	m	m	m	o	m
m	q	m	q	w	d	r	t	g	m
m	w	m	a	f	h	j	l	ñ	m
m	z	m	t	r	s	d			
m	x	m	w	g	h	l			
m	m	m	a	s	d	f			



Nombre..... Fecha.....

Lleva al mecánico con su moto siguiendo solo las letras "M".

			J	M	M	M	F	H	J
			N	M	T	M	R	S	D
			K	M	V	M	G	H	L
M	W	L	L	M	R	M	F	H	J
M	D	D	Ñ	M	E	M	F	H	J
M	F	M	M	M	S	M	M	M	M
M	G	M	O	O	L	Ñ	P	S	M
M	H	M	I	M	M	M	M	M	M
M	Y	M	U	M	S	D	F	G	T
M	U	M	T	M	D	R			
M	I	M	R	M	E	R			
M	M	M	E	M	M	M			



Nombre..... Fecha.....

 Encuentra las palabras escondidas en esta sopa de letras.

mono mama medico moto maleta

p	c	u	h	k	a	s	m	g	h
k	f	e	h	t	a	h	o	a	u
a	n	s	r	e	p	g	t	a	a
y	s	z	r	l	a	b	o	s	f
e	b	o	l	f	a	p	i	g	c
m	e	d	i	c	o	d	e	z	u
m	a	l	e	t	a	n	j	y	p
i	c	r	p	e	m	a	m	a	i
g	j	v	k	w	p	c	m	i	a
m	o	n	o	t	b	r	u	u	r

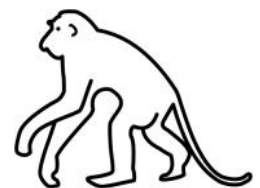



Nombre..... Fecha.....

 Encuentra las palabras escondidas en esta sopa de letras.

MONO MAMA MEDICO MOTO MALETA

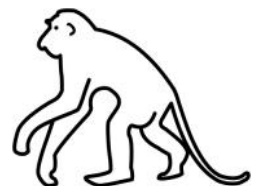



Nombre..... Fecha.....

 Encuentra las palabras escondidas en esta sopa de letras.

muleta muela mano marinero maíz

m	i	d	s	e	i	e	i	a	c
u	y	c	y	s	l	i	d	p	i
e	s	g	a	v	z	e	n	t	m
l	j	r	a	o	q	p	f	t	a
a	r	a	s	p	i	y	i	a	i
a	s	a	n	e	i	h	r	u	z
m	u	l	e	t	a	p	m	a	d
q	e	h	q	a	w	r	a	t	u
g	y	e	q	j	g	i	n	e	o
m	a	r	i	n	e	r	o	x	s

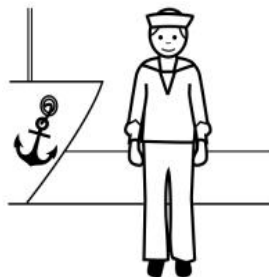



Nombre..... Fecha.....

 Encuentra las palabras escondidas en esta sopa de letras.

MULETA MUELA MANO MARINERO MAÍZ

S	I	A	Y	A	K	E	O	M	N
W	M	U	L	E	T	A	D	U	O
Y	O	F	T	S	U	M	M	E	Q
M	A	R	I	N	E	R	O	L	I
D	R	E	C	A	M	O	E	A	O
A	A	F	Y	S	K	P	Y	K	X
O	W	L	A	S	I	M	A	N	O
G	O	N	W	A	F	T	T	Y	H
G	Q	D	W	Z	R	W	U	E	K
M	A	I	Z	A	U	B	K	M	I

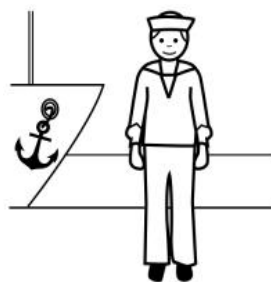





Nombre: ..... Fecha: .....

### LA LETRA m

Colorea las zonas que tengan la letra "m".

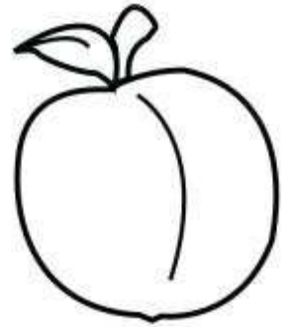



Nombre: ..... Fecha: .....

### LA LETRA m

Colorea las zonas que tengan la letra "m".

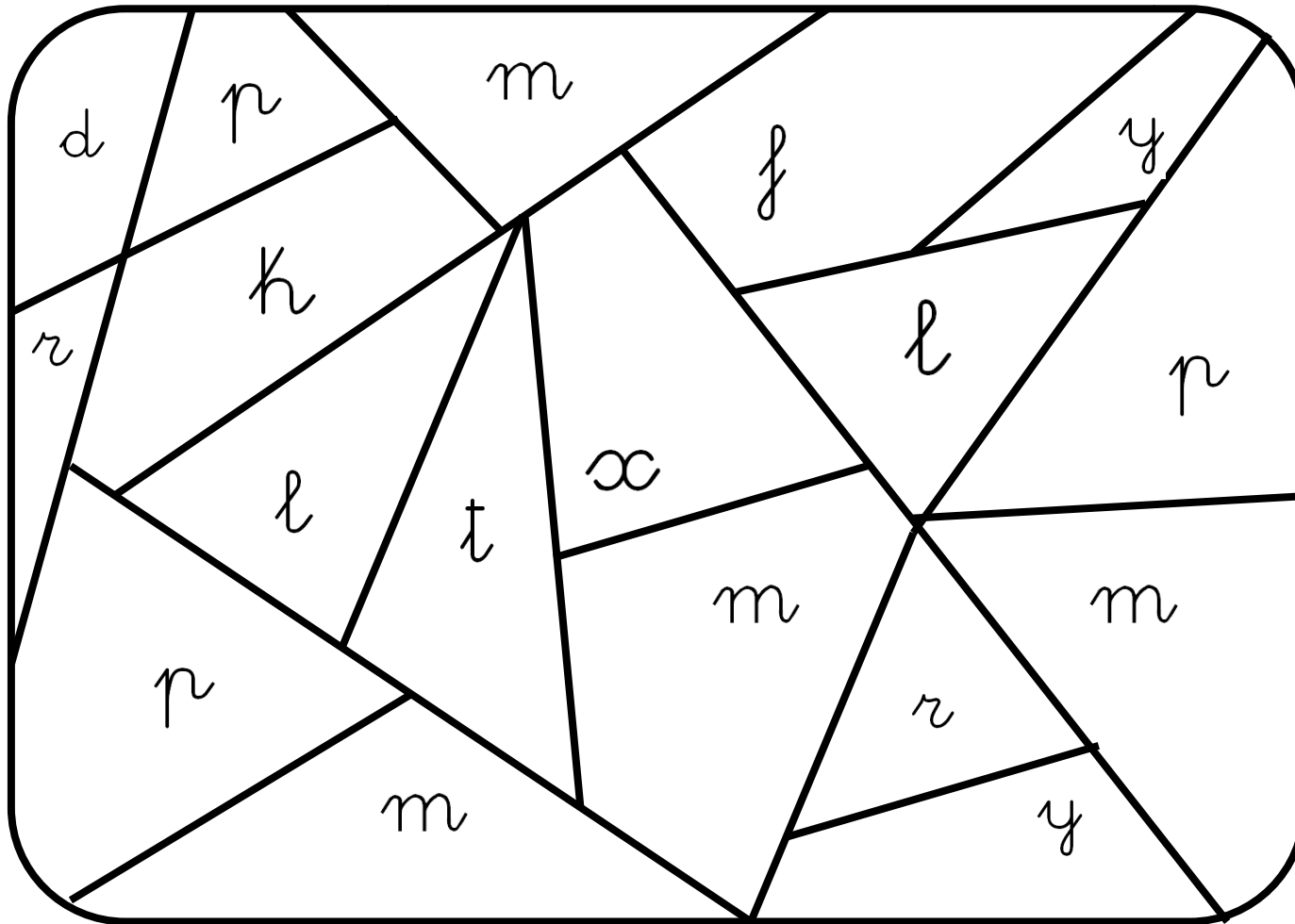



Nombre: ..... Fecha: .....

### LA LETRA m

Colorea las zonas que tengan la letra "m".

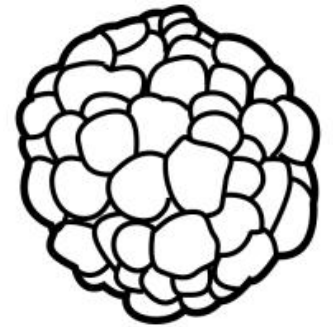
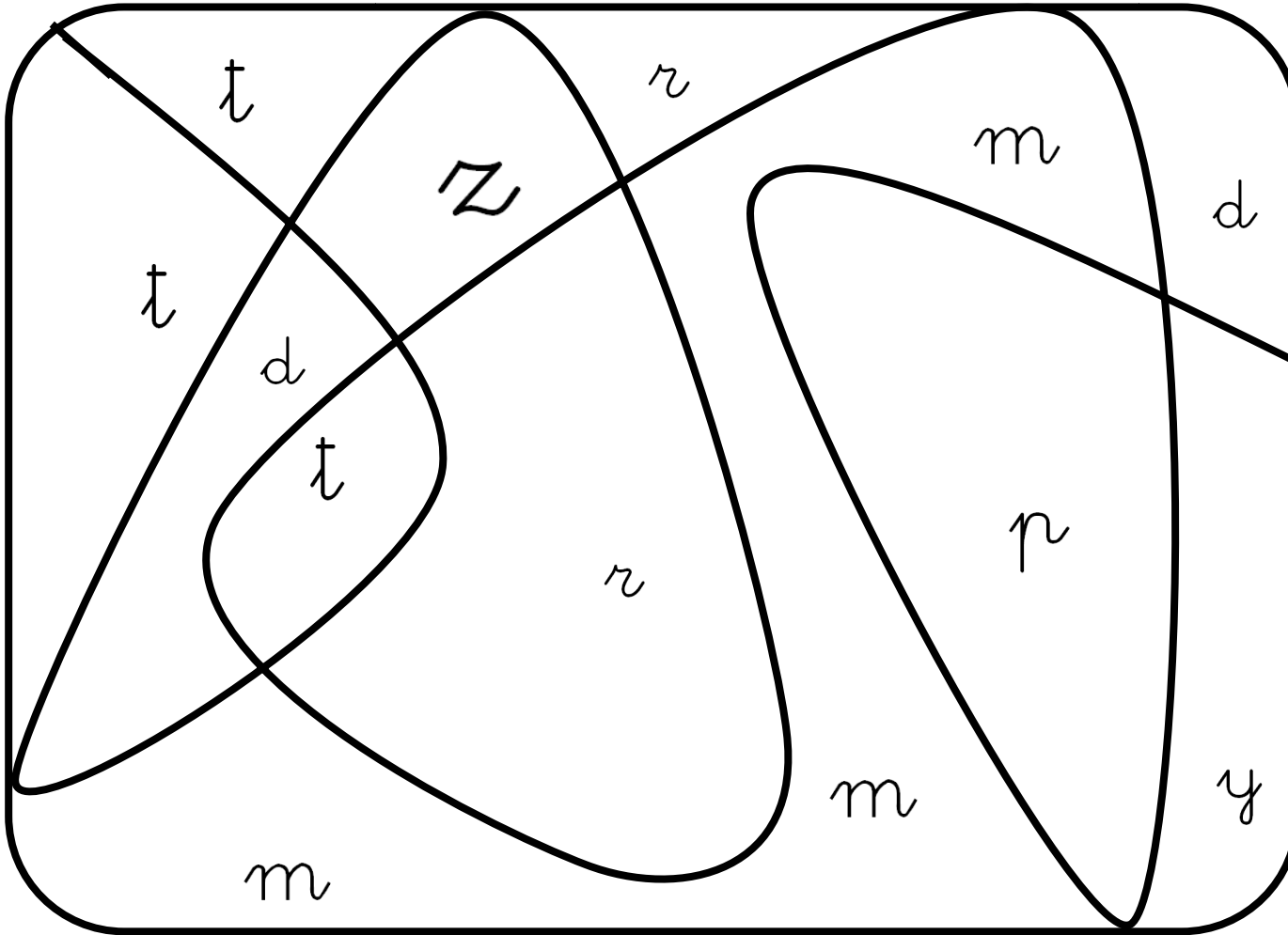
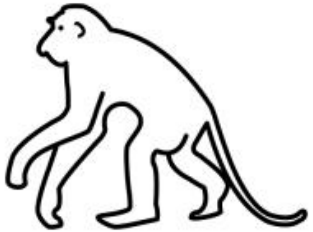



Nombre: ..... Fecha: .....

### LA LETRA M

Colorea las zonas que tengan la letra "M".

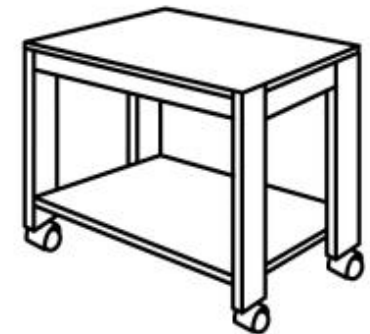
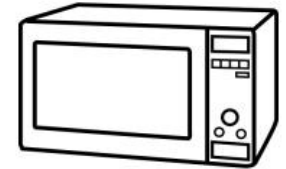
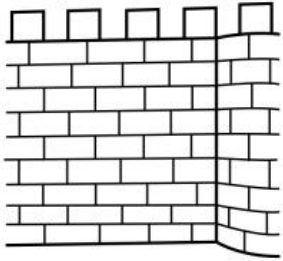



Nombre: ..... Fecha: .....

### LA LETRA M

Colorea las zonas que tengan la letra "M".

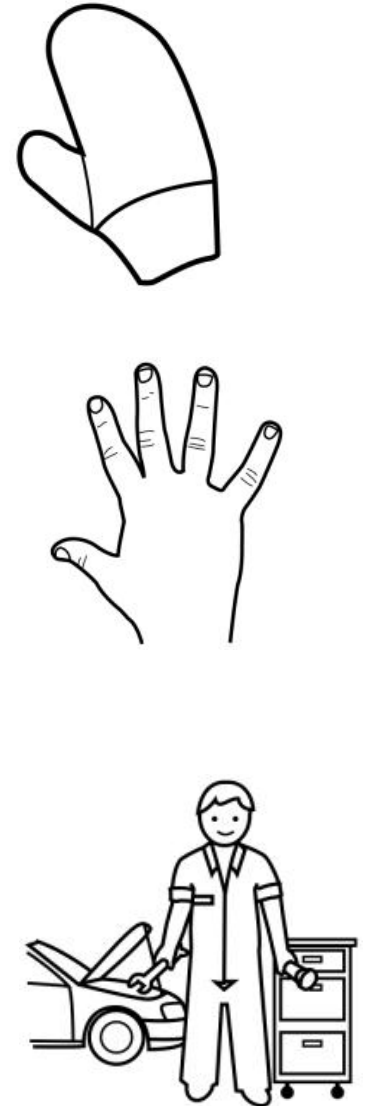
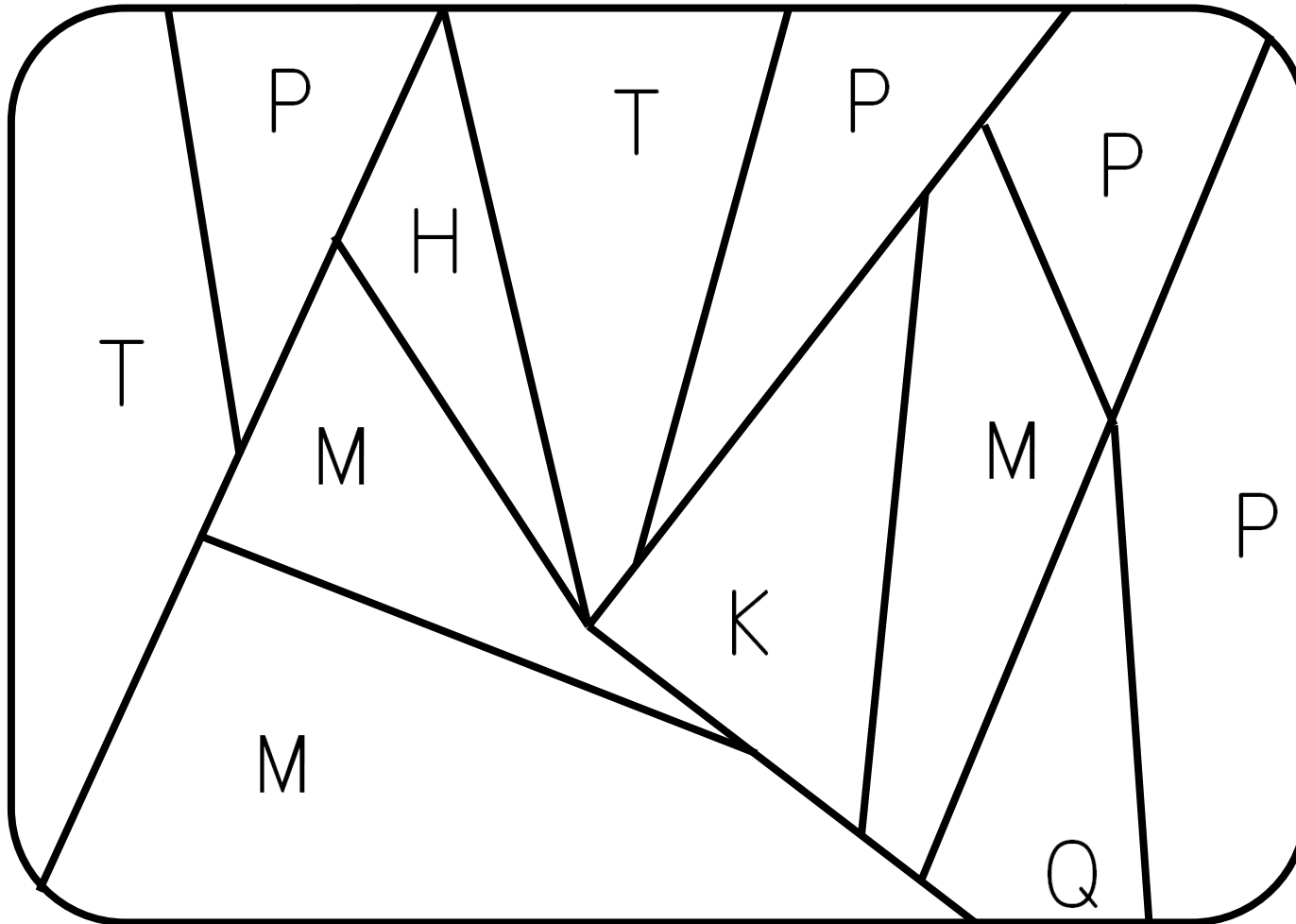



# El Juego de la Oca vamos a aprender la letra /m/

			<b>PIERDES UN TURNO</b>			<b>TIRA OTRA VEZ</b>			<b>Avanza diez casillas</b>
			<b>Avanza a la meta</b>			<b>Retrocede ocho casillas</b>			<b>TIRA OTRA VEZ</b>
<b>PIERDES UN TURNO</b>									
		<b>Vuelve a la Salida</b>			<b>TIRA OTRA VEZ</b>				



# Casillas

1.- <b>Salida.</b>	17.- mapa
2.- mamá	18.- avanza a la meta
3.- mono	19.- mesa
4.- pierdes un turno	20.- malo
5.- mochila	21.- mago
6.- moto	22.- pierdes un turno
7.- tira otra vez	23.- maracas
8.- mano	24.- madera
9.- músico	25.- vuelve a la salida
10.- avanza diez casillas	26.- melocotón
11.- maleta	27.- marinero
12.- tira otra vez	28.- tira otra vez
13.- médico	29.- monedero
14.- melón	30.- medalla
15.- retrocede ocho casillas	31.- mariposa
16.- muleta	32.- <b>Meta</b>

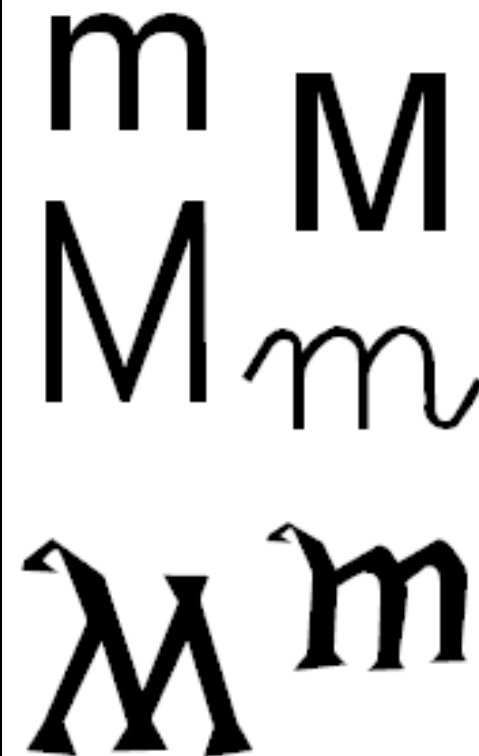
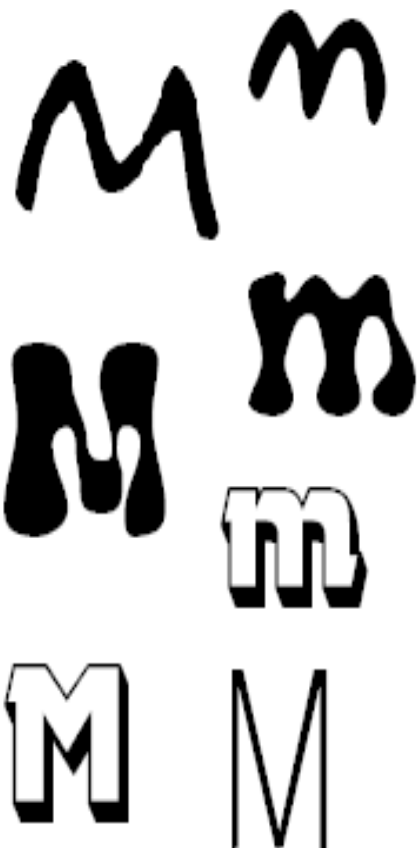





Nombre..... Fecha.....

# LA LETRA M m

ma me mi mo mu

am em im om um

Mamá mapa puma Mimí

mimo miao mio poma mima

Mi mamá me mima

Amo a mi mamá

Meme ama a mamá

Mi poma y mi mamá

Mi mamá ama a mi papá.





Nombre..... Fecha.....

# LA LETRA M m

ma me mi mo mu

am em im om um

Moto mala mopa meme

mima mula mata mola

Mi mula mala

Amo a mi moto

La mula me mola

Mamá ama a lila

Mi lima y mi maleta

# INTRUSOS SILÁBICOS

De las 4 imágenes hay una que no debería estar, ya que empieza por una sílaba diferente, señala cual es.

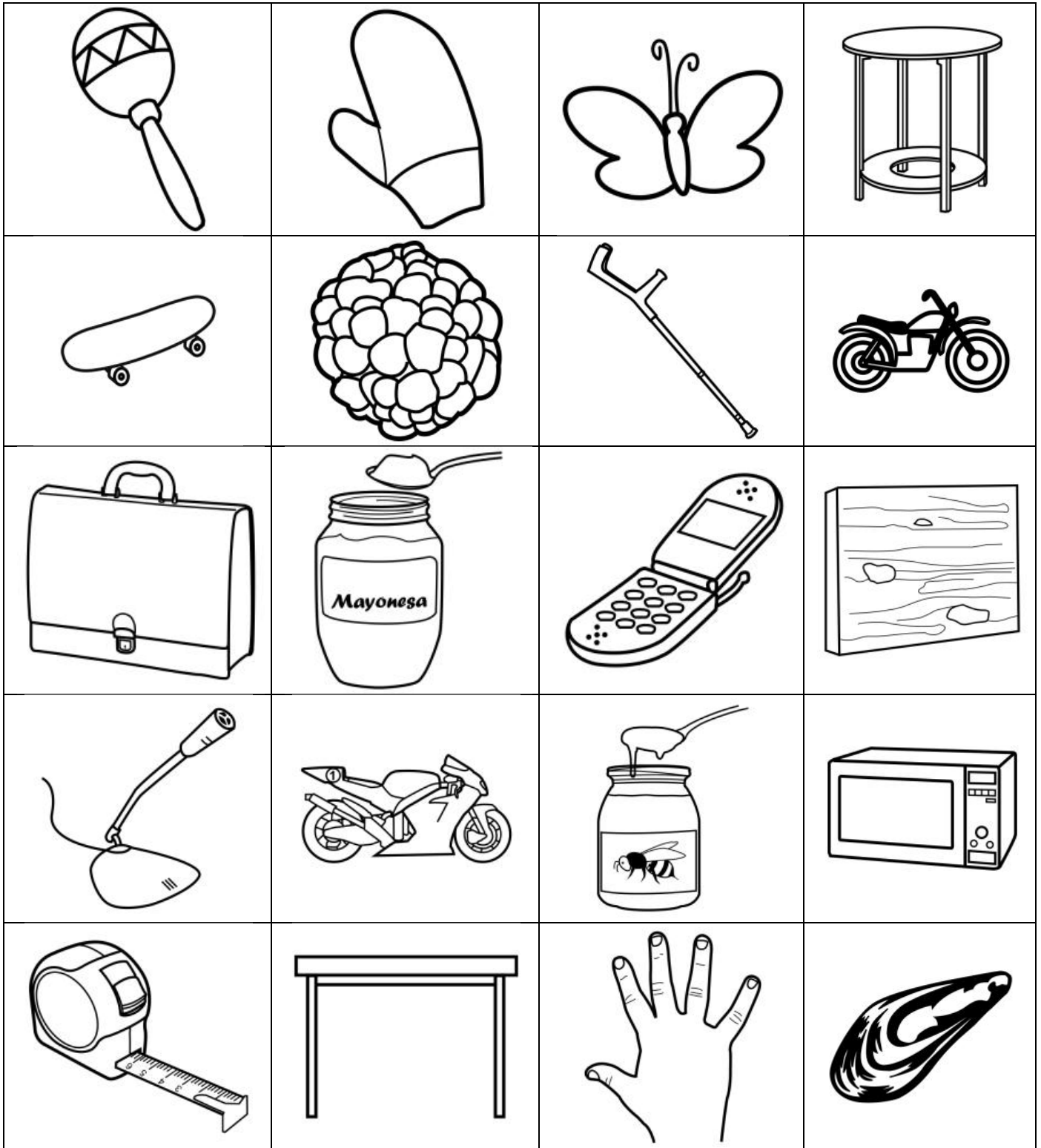

# INTRUSOS SILÁBICOS

## Soluciones

### Primera fila

maraca-manopla-mariposa-mesa

### Segunda fila

monopatin-mora-muleta-noto

### tercera fila

maletín-mayonesa-móvil-madera

### Cuarta fila

micrófono-noto-miel-microondas

### Quinta fila

metro-mesa-mano-mejillón