

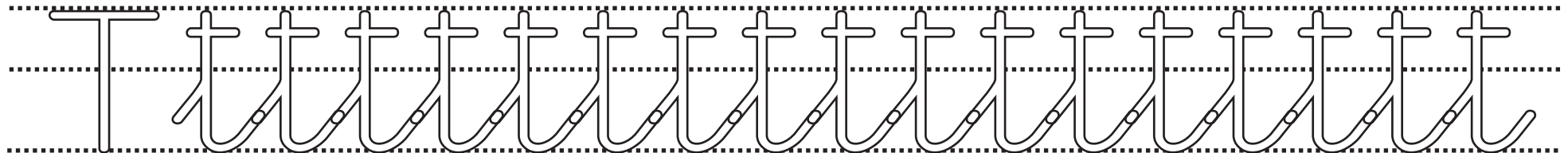

Grafía de la letra T.  
Técnica: Repasar con pinturas.

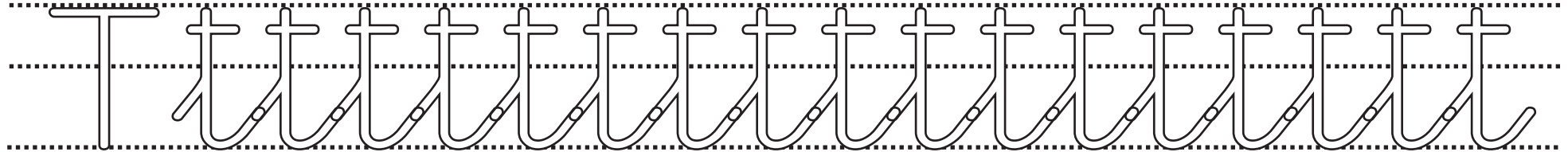

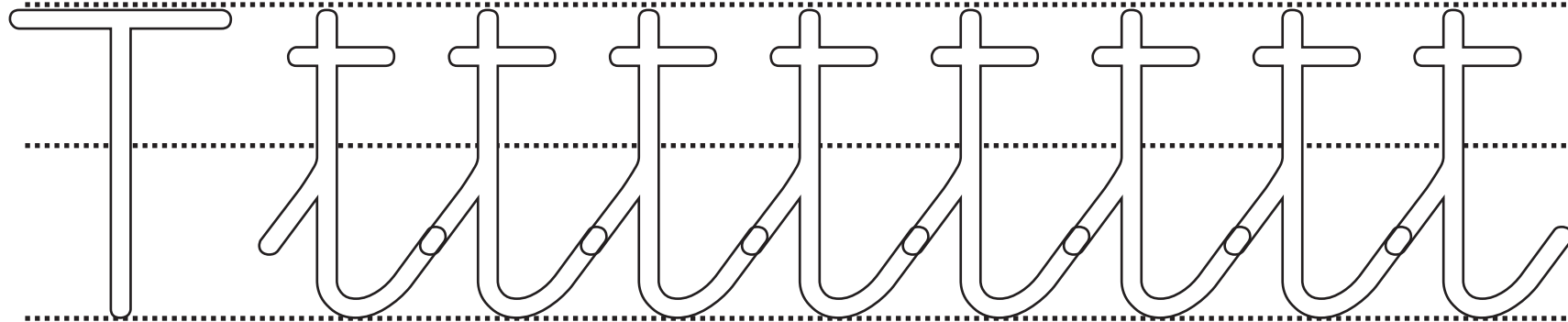
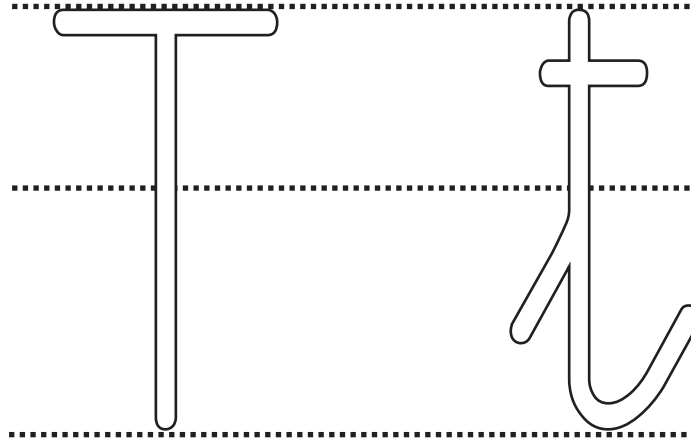
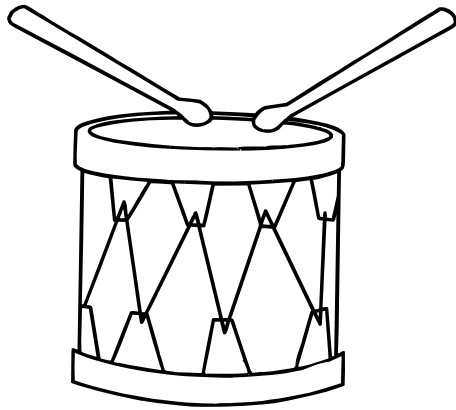

Grafía de la letra T  
Técnica: Repasar con pinturas.

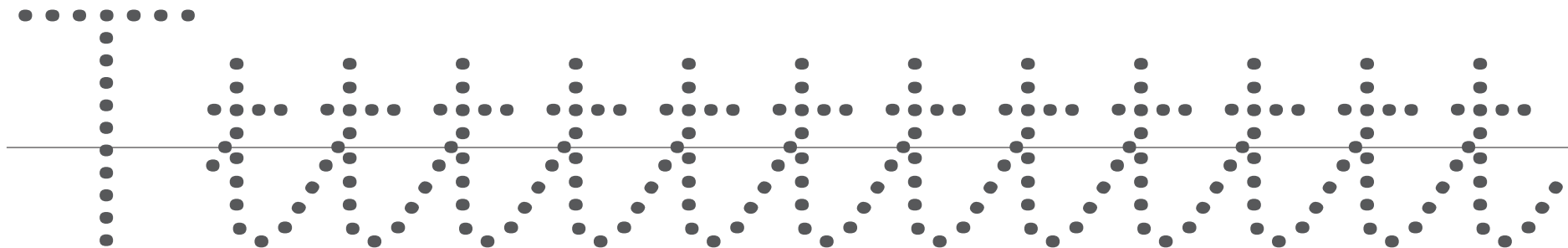
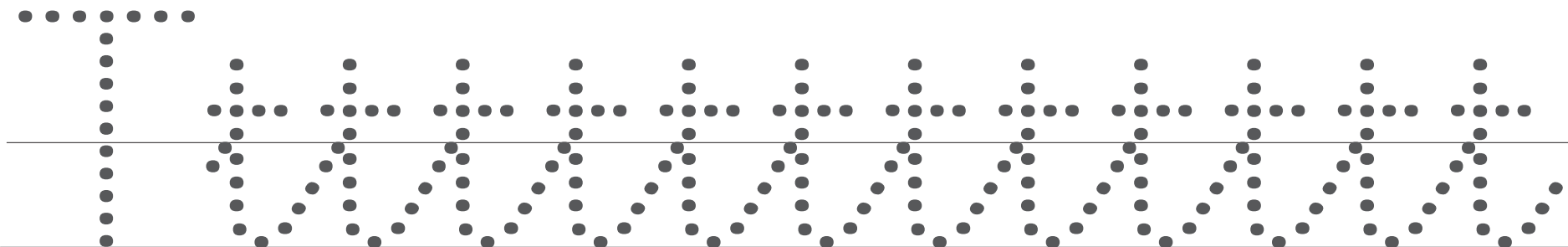
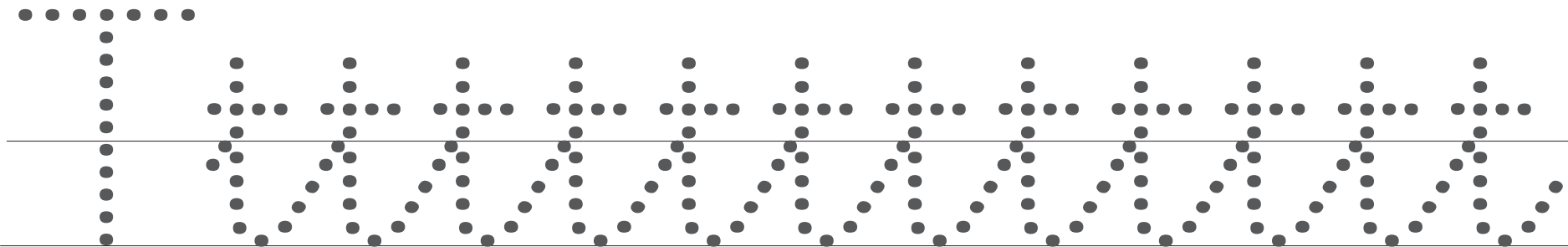

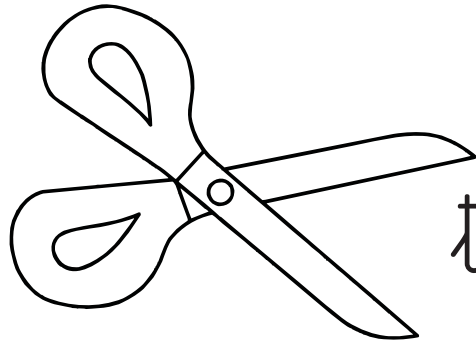

tijeras



teléfono

t

t

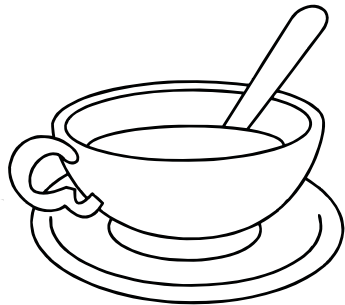

taza



topo

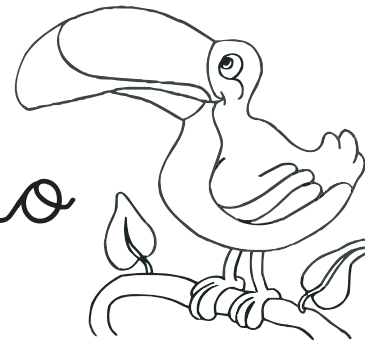

tucán

t

t

t

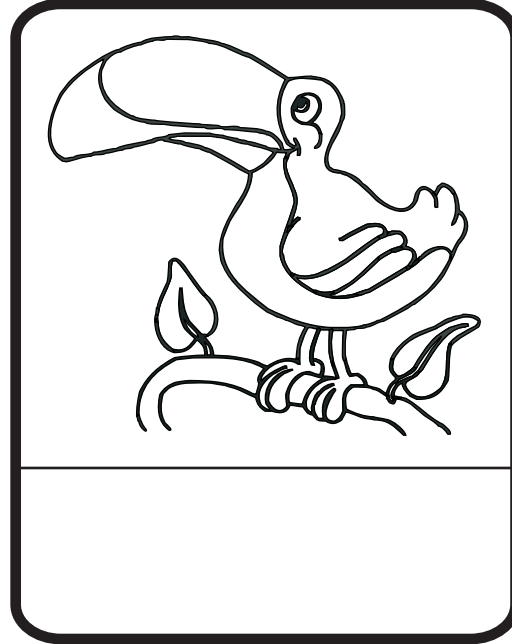
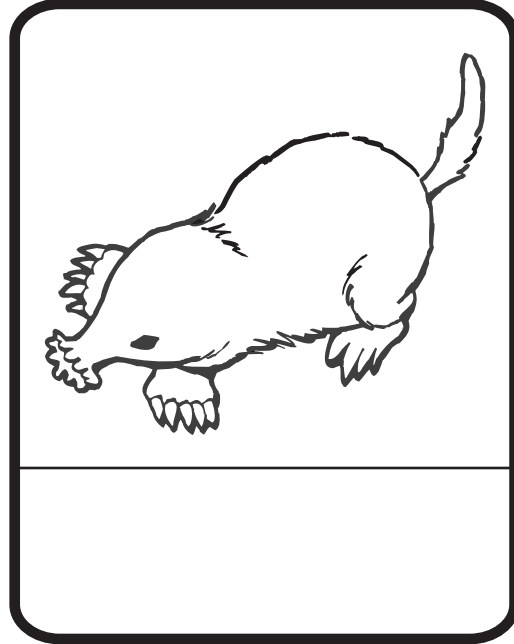
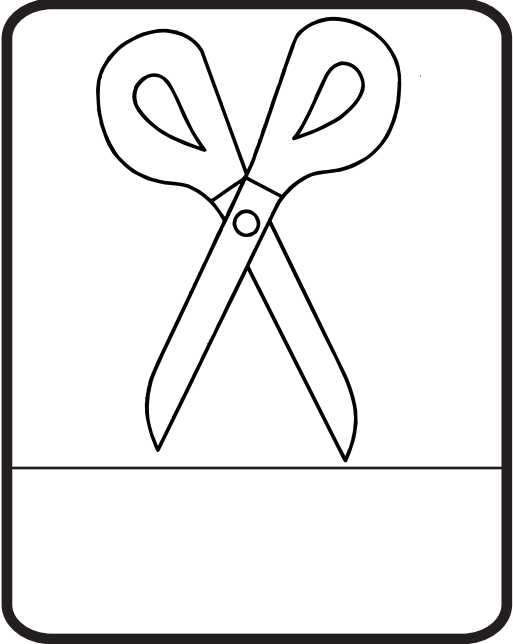
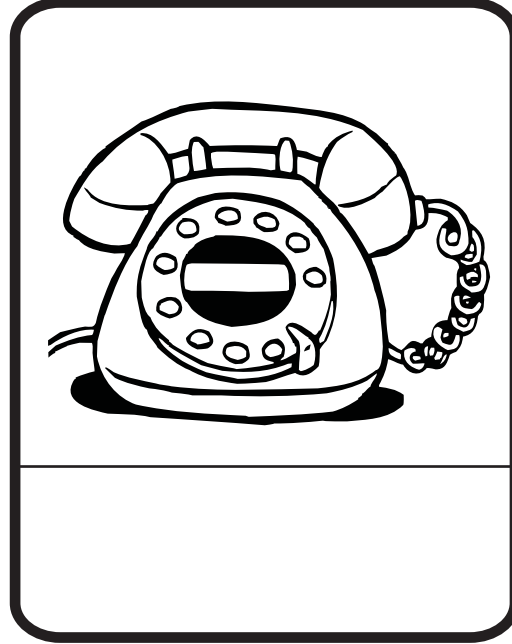
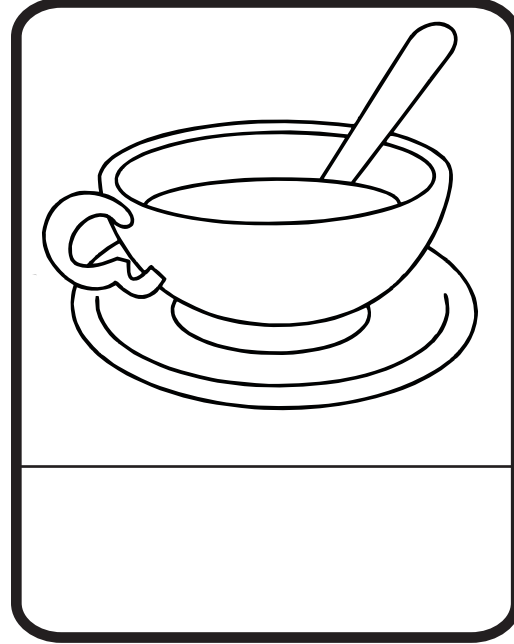
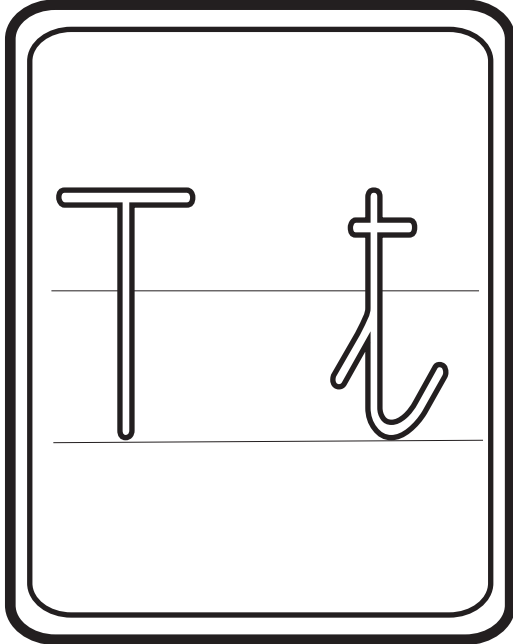

teléfono

tijeras

leño

taza

tucán



Presentación letra T.

Técnica: Colorear y repasar con pinturas

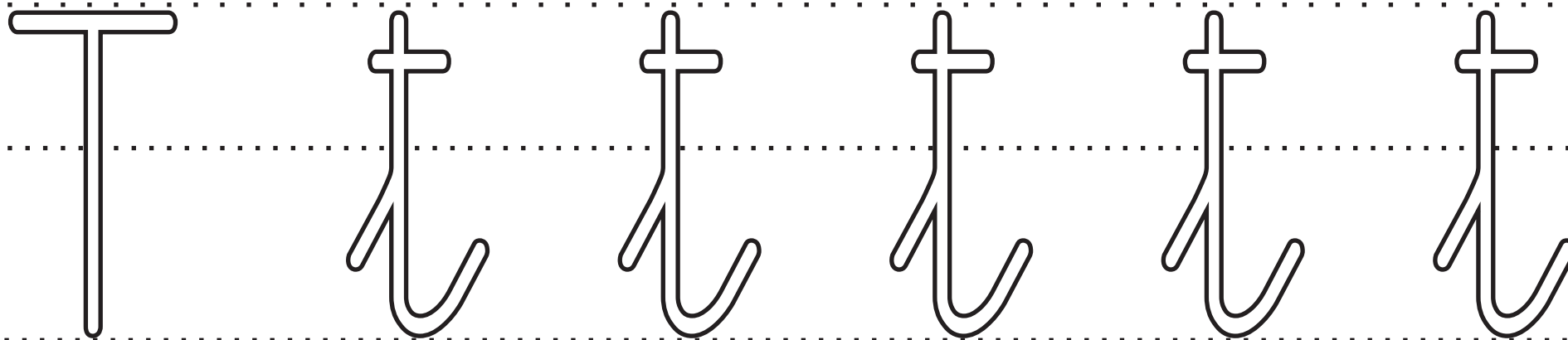
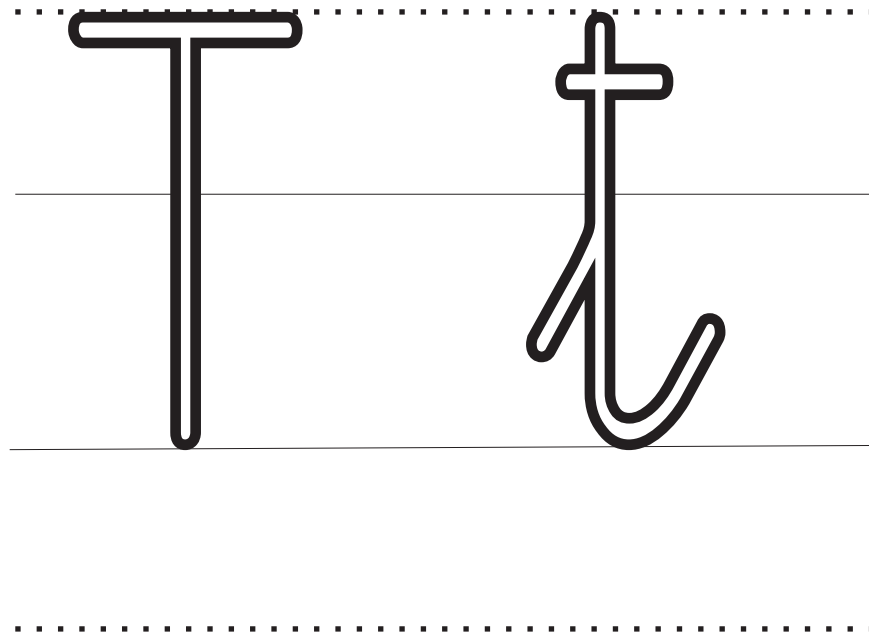
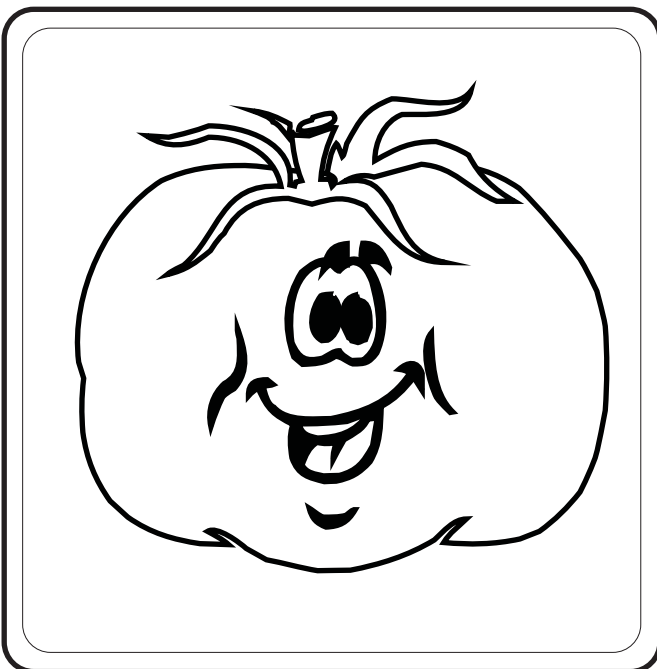



Presentación letra T.

Técnica: Colorear y repasar con pinturas

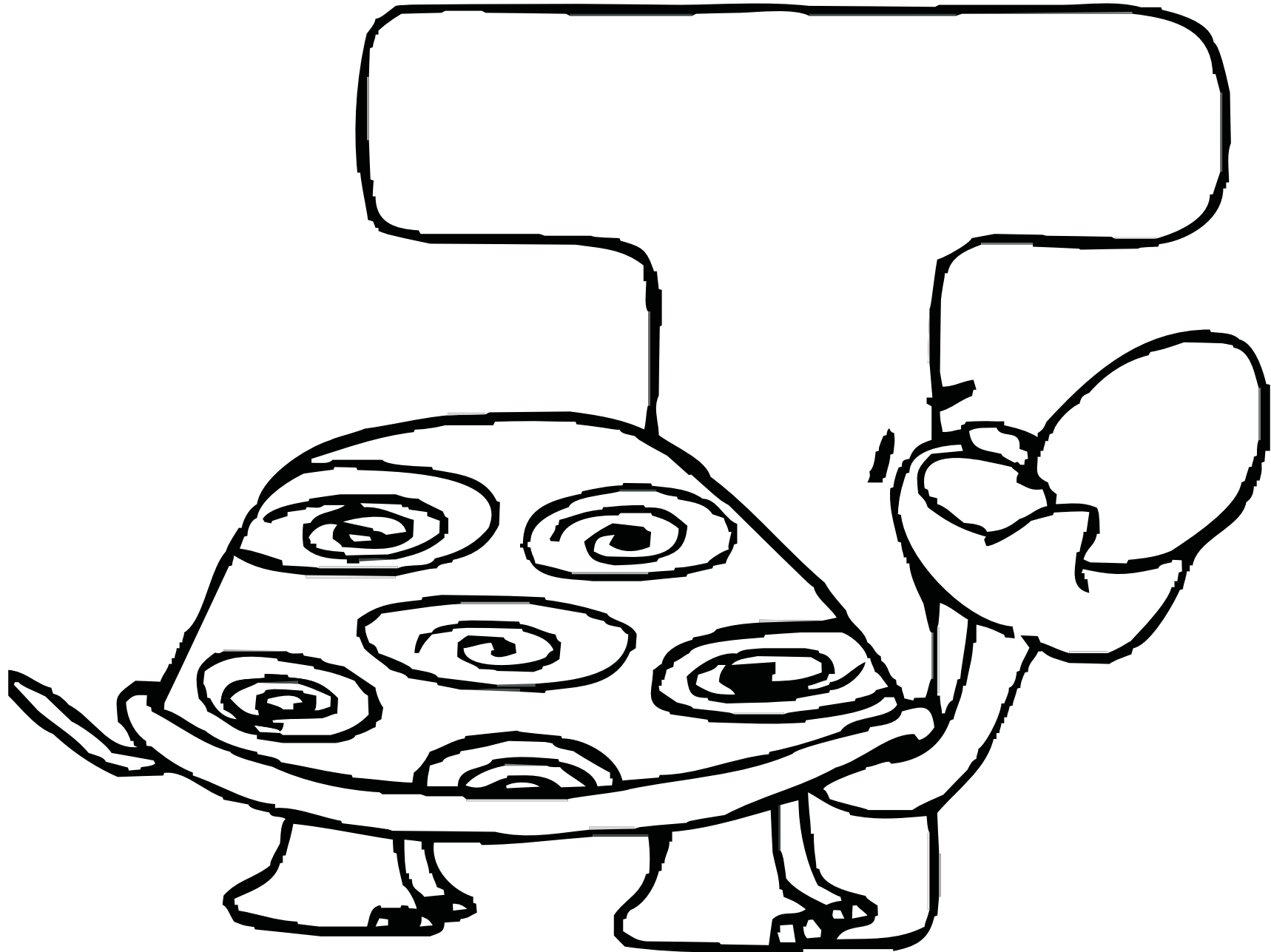



Discriminación visual y auditiva.  
Técnica: Rodear las letras: T y t

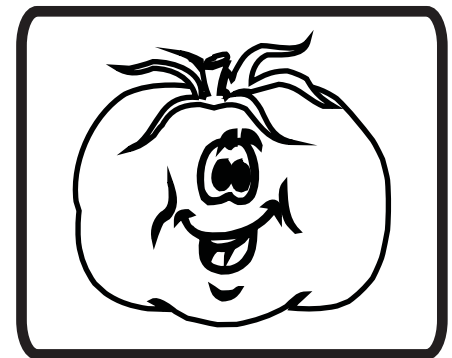
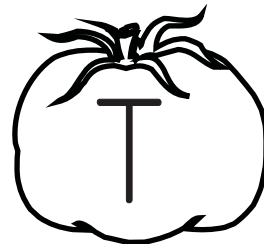
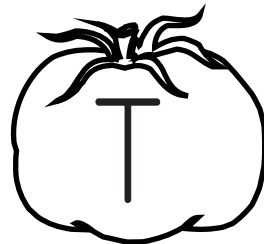
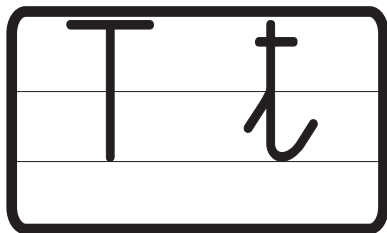
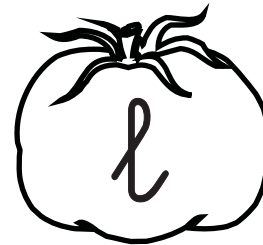
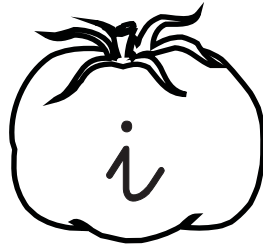
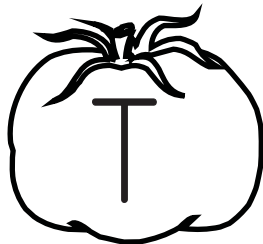
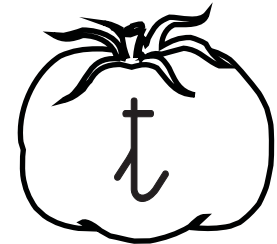
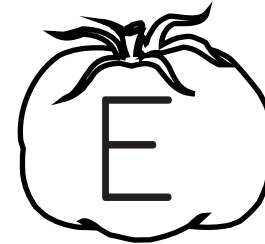
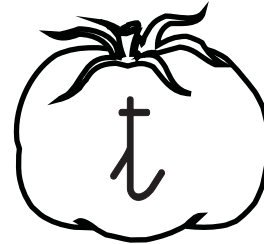
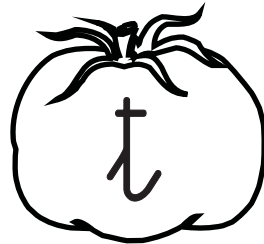
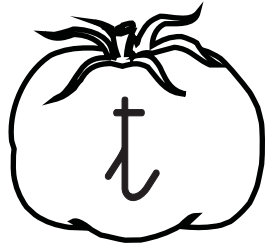
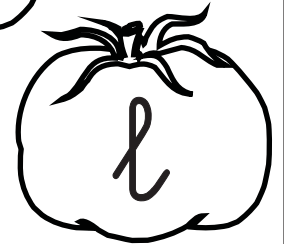
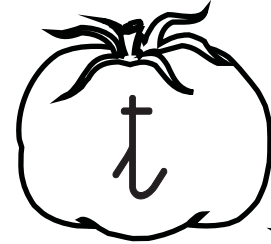
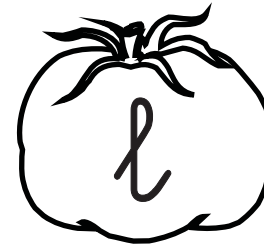
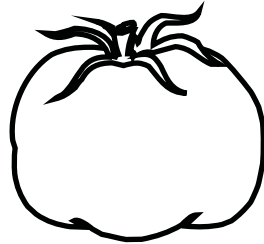
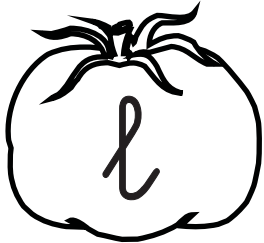
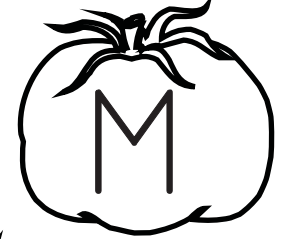
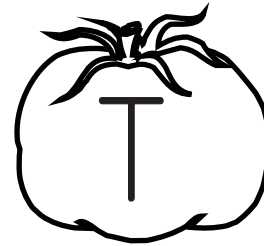
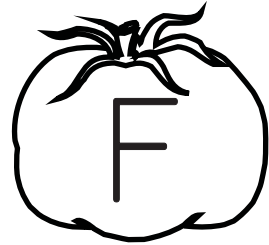
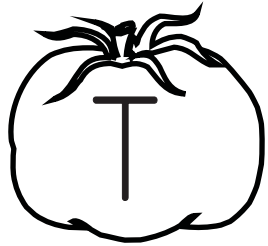



Percepción auditiva

Técnica: Colorear elementos que tengan la letra T

