

c Cl

cl Cl

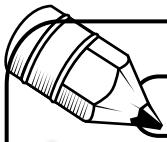

Nombre: _____



Fecha: _____



cla - cle - clo - cli - clu

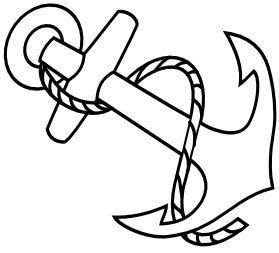

El ancla

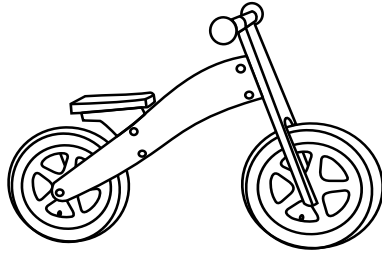

Una bicicleta

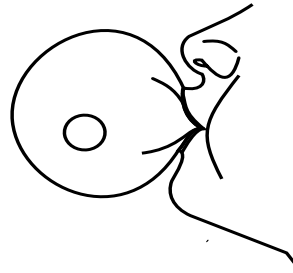

Un chicle

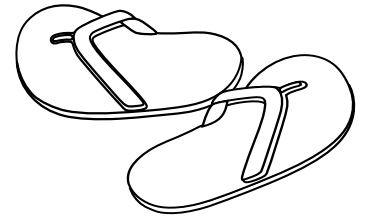

Unas chanclas



Una claqueta de cine



La clara



El clarinete

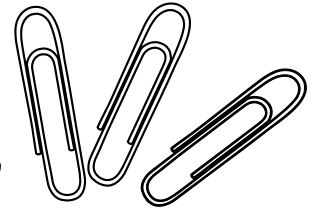

Unos clip

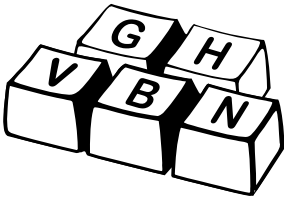

Las teclas del teclado

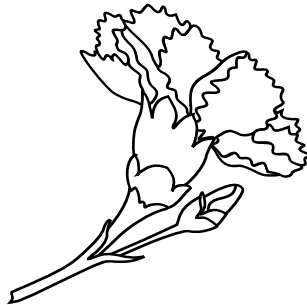

Un clavel



La clave de Sol

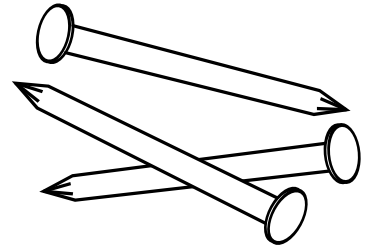

Los clavos



A Claudia le gusta la música clásica. Lo que más le gusta tocar, con su clarinete, es "Claro de Luna". Sus amigos Anacleto y Clemente, que son teclistas de un grupo de rock, la aclaman cuando la escuchan.

También mezcla su afición con el ciclismo, por lo que todos los días va a clase en una bicicleta que le regaló Santa Claus en Navidad.



Nombre: _____



Fecha: _____



Escribe "cl" y el nombre de los dibujos.



→ *cl cl cl cl cl cl cl cl cl cl*

→ *cl cl cl cl cl cl cl cl cl cl*

→

→

→

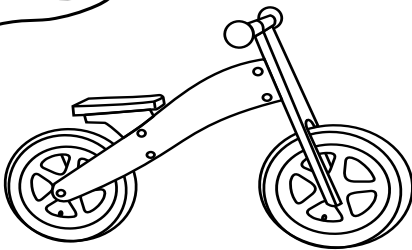
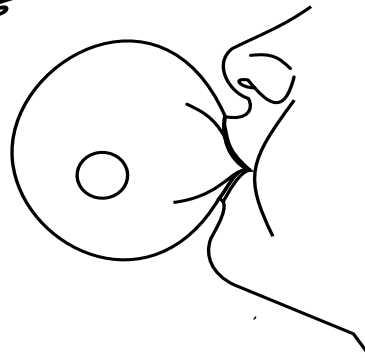
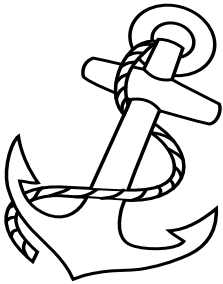
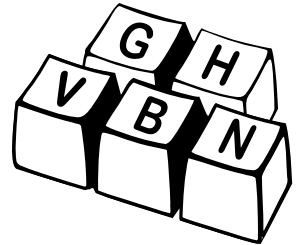
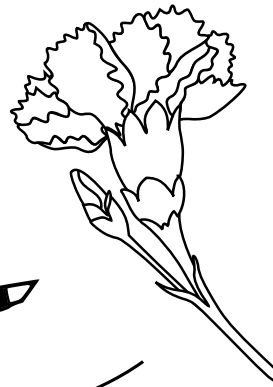
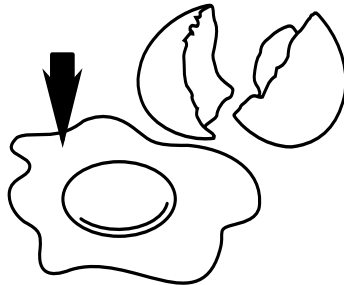
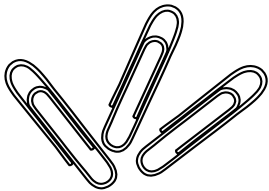

→

→

→

→

→

→



Nombre:

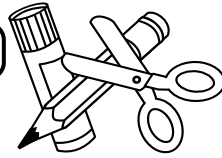

Fecha:



Recorta y pega en tu cuaderno. Escribe la palabra

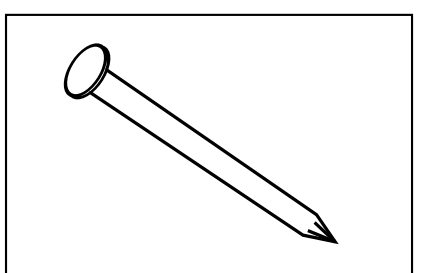
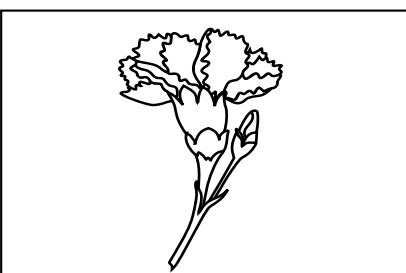
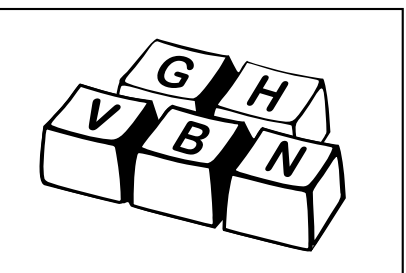
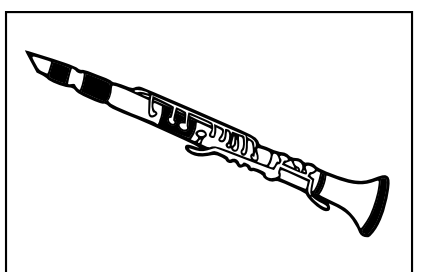
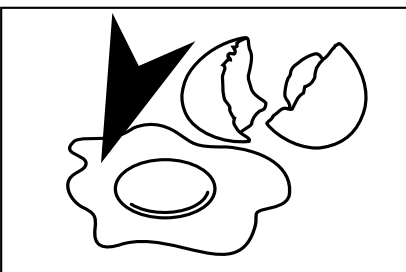
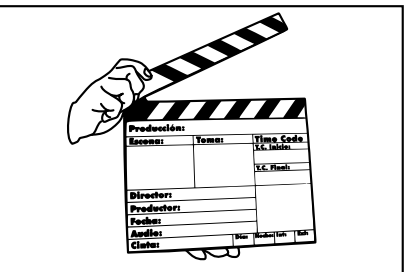
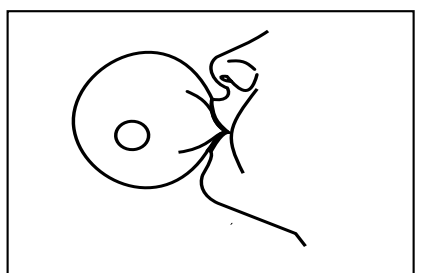
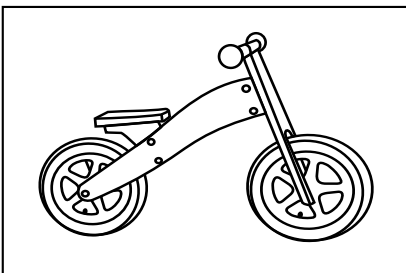
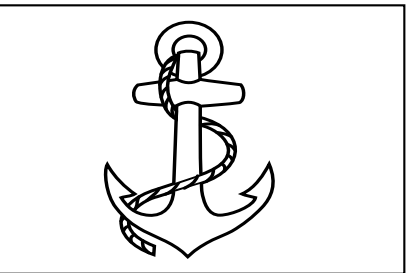
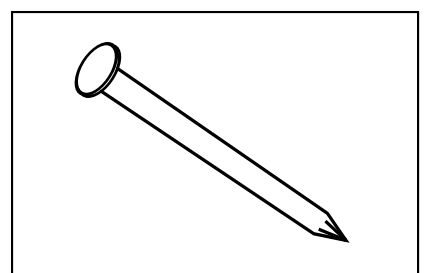
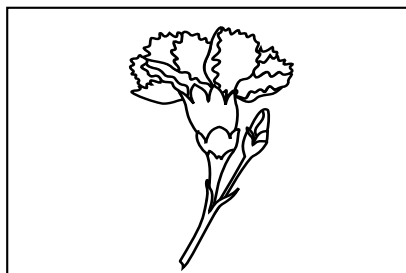
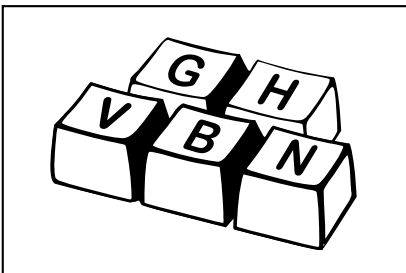
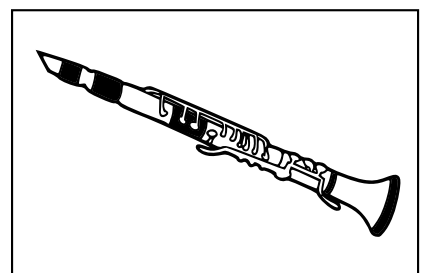
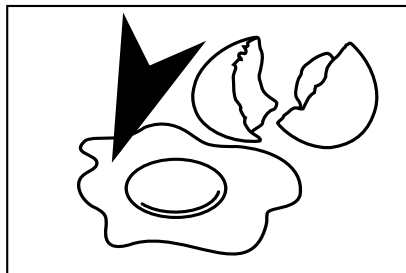
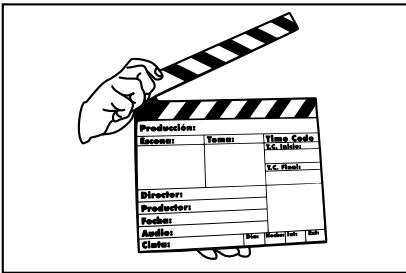
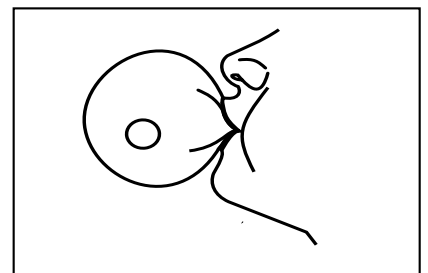
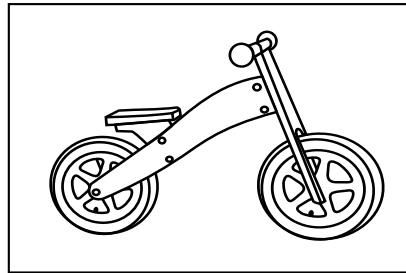
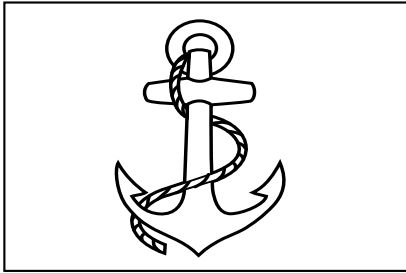

Nombre:

Fecha:

Inventa frases, con los dibujos que hay en los recuadros, en las que aparezcan palabras con la letra:



masticar
comer
hacer
...



ir
estar
andar
...



oler
cortar
plantar
...



poner
conducir
colocar
...



tocar
sonar
precionar
...



escribir
copiar
anotar
...



masticar
comer
hacer
...



ir
estar
andar
...



oler
cortar
plantar
...



poner
conducir
colocar
...



tocar
sonar
precionar
...



escribir
copiar
anotar
...



masticar
comer
hacer
...





ir
estar
andar
...





oler
cortar
plantar
...



poner
conducir
colocar
...

tocar
sonar
precionar
...



escribir
copiar
anotar
...





masticar
comer
hacer
...





ir
estar
andar
...





oler
cortar
plantar
...

poner
conducir
colocar
...

tocar
sonar
precionar
...





escribir
copiar
anotar
...



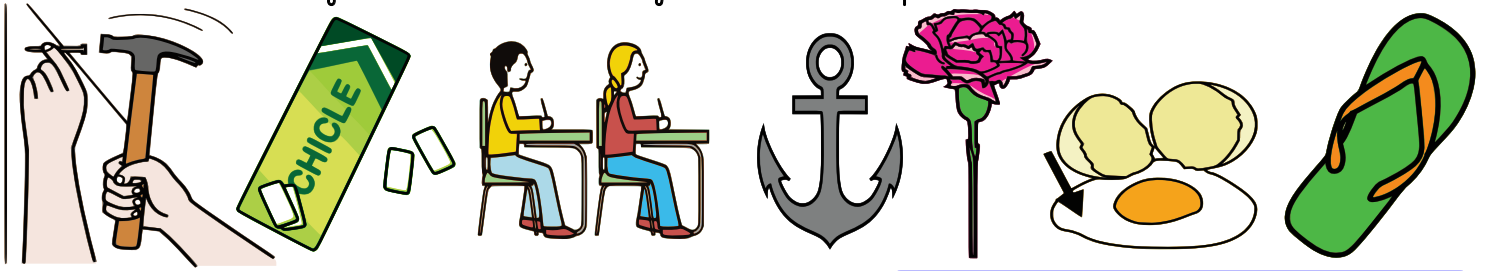

Ordena las siguientes sílabas y escribe las palabras en tu cuaderno.



no-cla

de-chi

se-cla

cla-an

vel-cla



ra-cla

cla-chan

clar-re-ci

tas-ci-clis

ta-bi-de-ci

Ordena las siguientes palabras y escribe las frases en tu cuaderno.

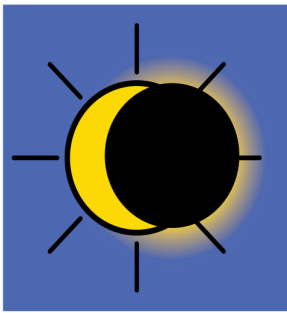

un eclipse de sol. Hoy ha habido

de la bicicleta. la rueda se pinchó



Clara su triciclo. corre con



Escribo muy en el teclado. rápido

es divertida. de matemáticas La clase

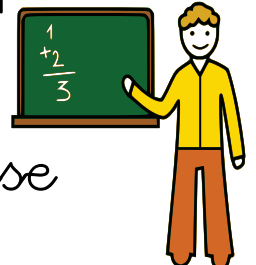

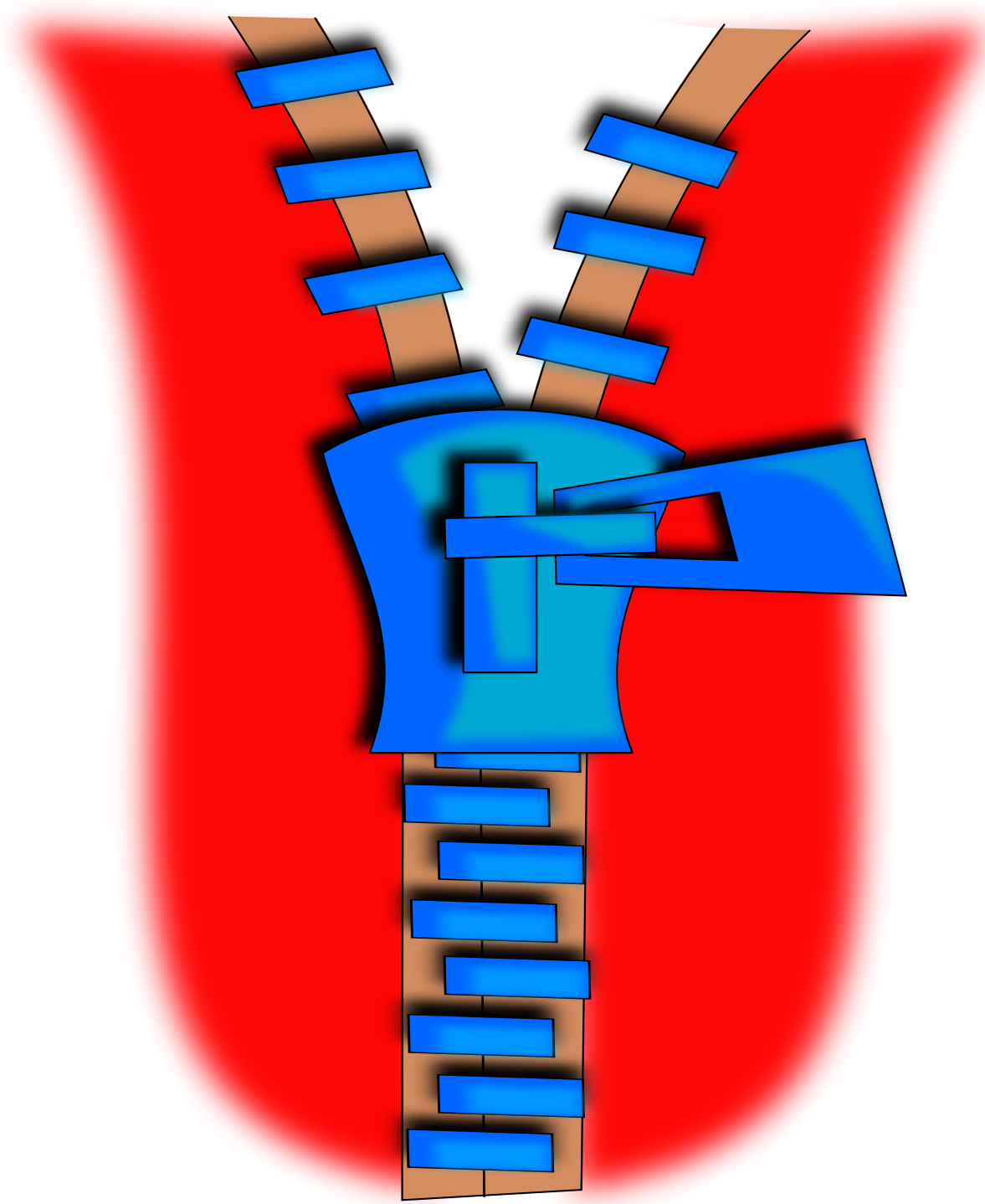

cr Cr

cr Cr





Nombre:



Fecha:



Escribe "cr" y el nombre de los dibujos.



→ *cr cr cr cr cr cr cr cr cr cr cr*

→ *cr cr cr cr cr cr cr cr cr cr cr*

→

→

→

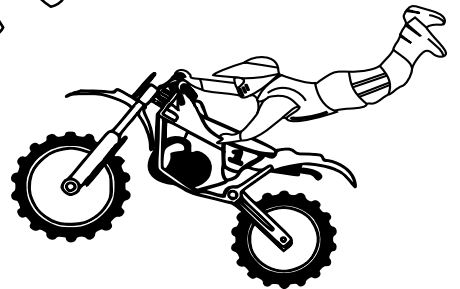
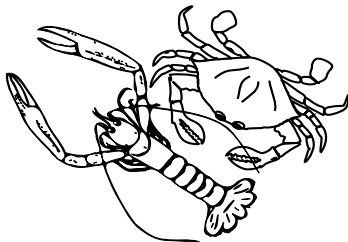
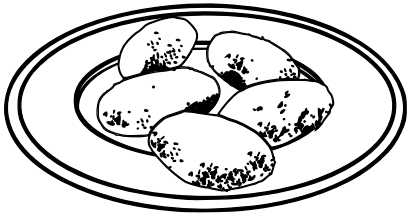
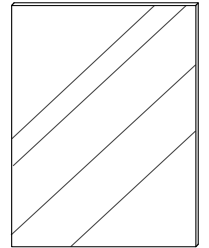
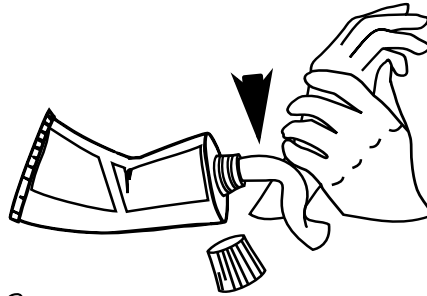
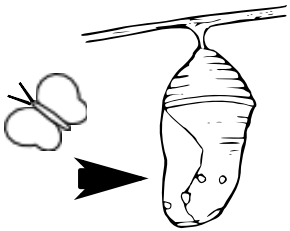
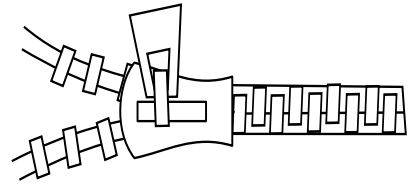
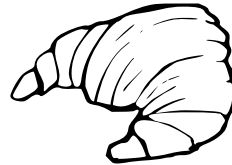
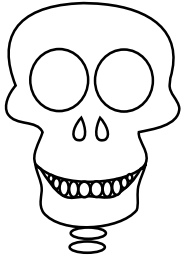

→

→

→

→

→

→



Nombre:



Fecha:



Escribe "cr" y el nombre de los dibujos.



→ *cr cr cr cr cr cr cr cr cr cr*

→ *cr cr cr cr cr cr cr cr cr cr*

→

→

→

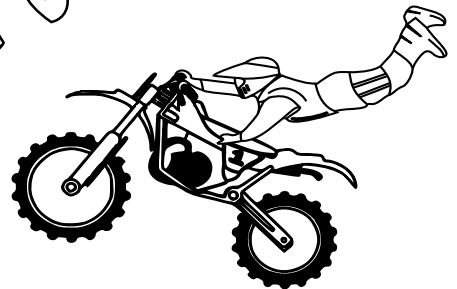
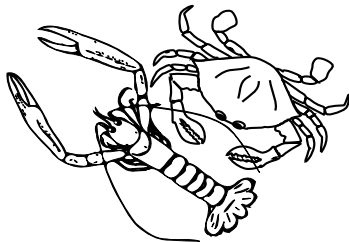
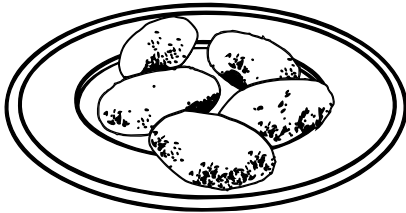
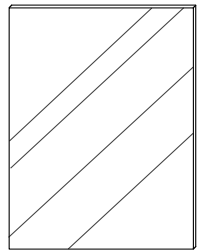
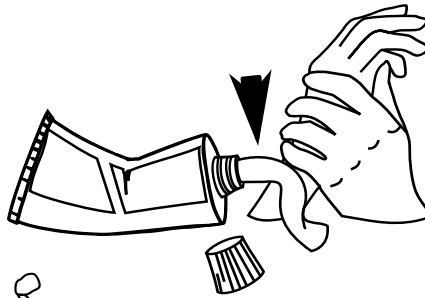
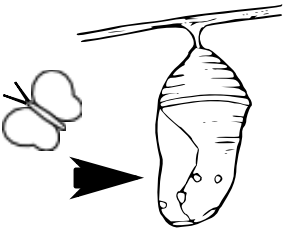
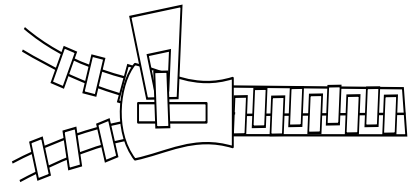
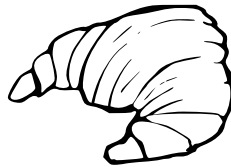

→

→

→

→

→

→



Nombre:

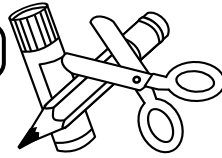

Fecha:



Recorta y pega en tu cuaderno. Escribe la palabra

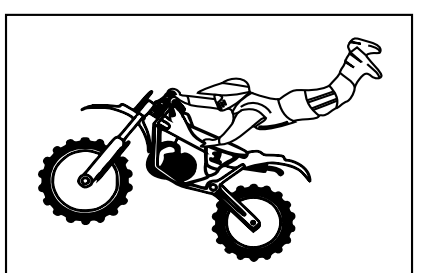
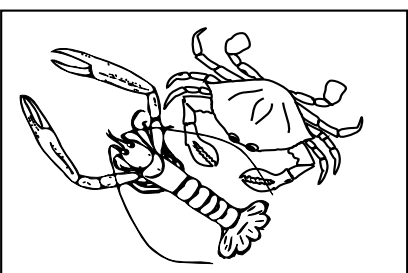
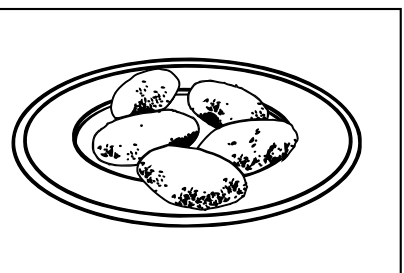
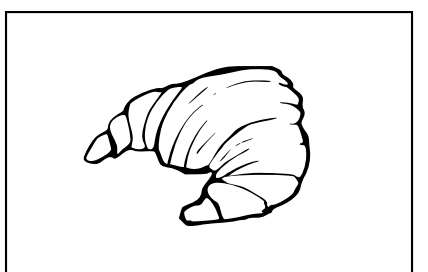
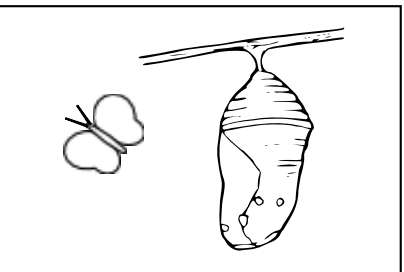
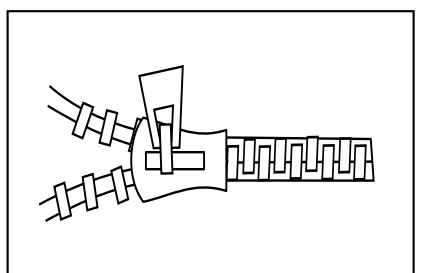
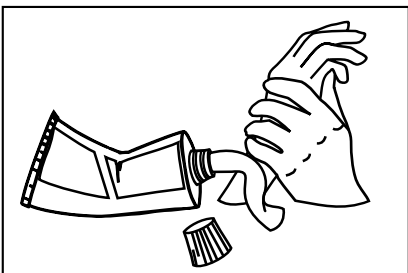
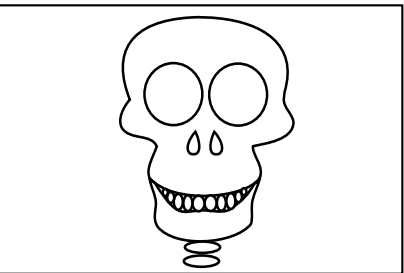
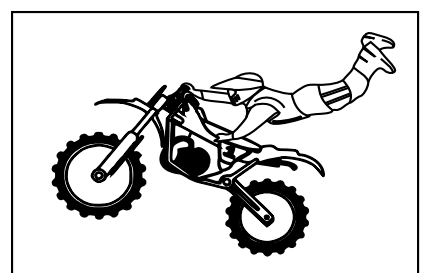
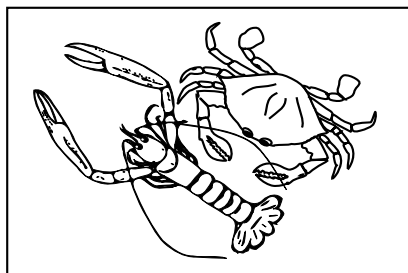
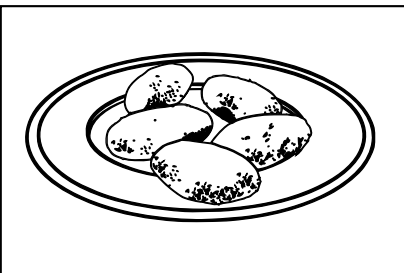
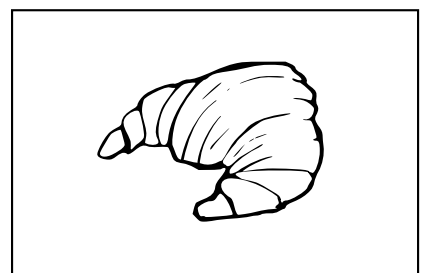
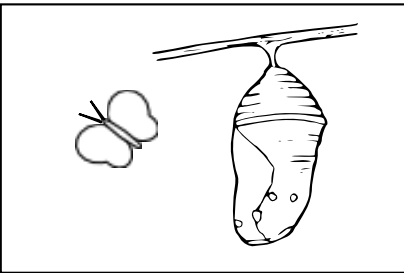
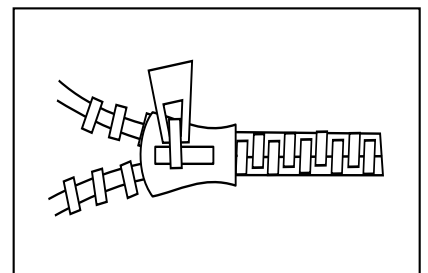
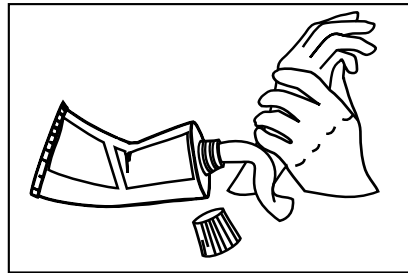
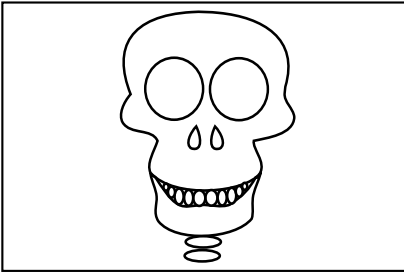



Nombre: _____

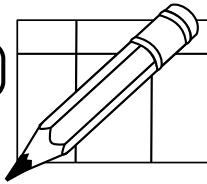

Fecha: _____



Completa las siguientes palabras y clasificalas en el dibujo que tenga su sílaba

cra - cre - cro - cri - cru



Pan___cio ___mallera ___mos

___nómetro ___cero ___cer

___stina demo___cia ___stales

___ter ___cigrama ___ce

in___ible ___ado ___canti

ORDENA

LAS PALABRAS

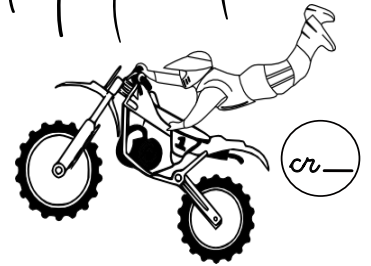
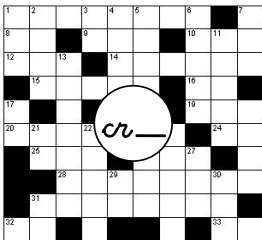

Large grid for writing the words from the list above.

cr_

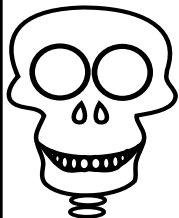

Grid for writing the word 'crucifijo'.

cr_

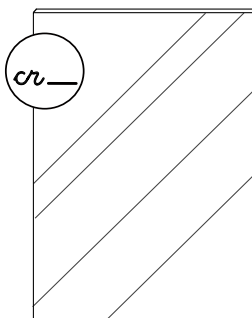

Grid for writing the word 'crucero'.



Nombre: _____

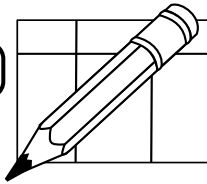

Fecha: _____



Completa las siguientes palabras y clasificalas en el dibujo que tenga su sílaba

cra - cre - cro - cri - cru



Pan__cio __mallera __mos

__nómetro __cero __cer

__stina demo__cia __stales

__ter __cigrama __ce

in__ible __ado __canti

ORDENA

LAS PALABRAS

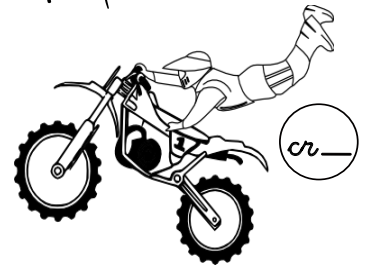
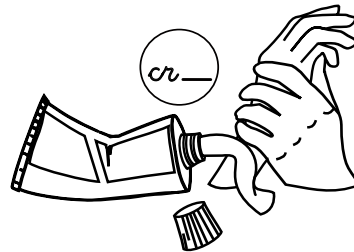
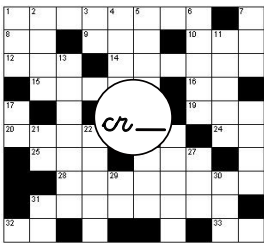

Handwriting practice lines with arrows pointing right.

Handwriting practice lines with arrows pointing right.

Handwriting practice lines with arrows pointing right.

Handwriting practice lines with a skull illustration and a circle containing 'cr'.

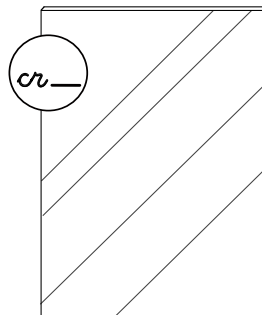

Handwriting practice lines with arrows pointing right.

Nombre:

Fecha:



Inventa frases, con los dibujos que hay en los recuadros, en las que aparezcan palabras con la letra:



untar
poner
hidratar
...



pescar
comer
capturar
...

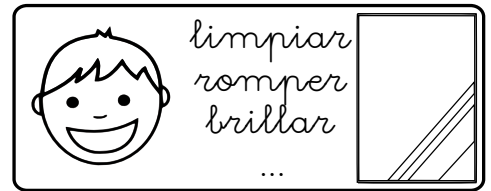

limpiar
romper
brillar
...



salir
romper
asomar
...



pegar
poner
guardar
...



comer
hacer
rellenar
...



untar
poner
hidratar
...



pescar
comer
capturar
...

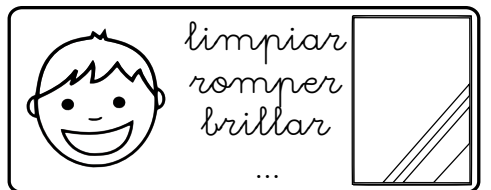

limpiar
romper
brillar
...



salir
romper
asomar
...



pegar
poner
guardar
...



comer
hacer
rellenar
...



untar
poner
hidratar
...



pescar
comer
capturar
...

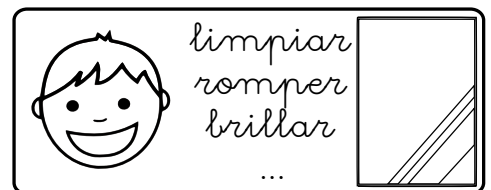

limpiar
romper
brillar
...



salir
romper
asomar
...

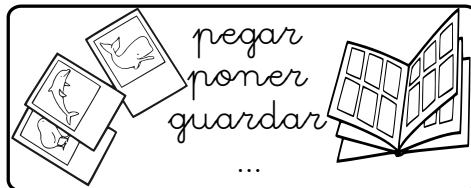

pegar
poner
guardar
...



comer
hacer
rellenar
...



untar
poner
hidratar
...



pescar
comer
capturar
...

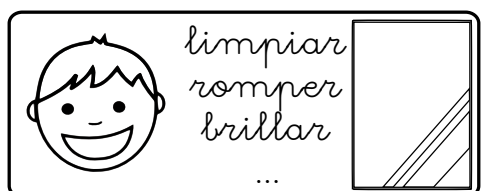

limpiar
romper
brillar
...



salir
romper
asomar
...



pegar
poner
guardar
...



comer
hacer
rellenar
...

Nombre: _____

Fecha: _____



Completa el crucigrama y escribe las palabras abajo.

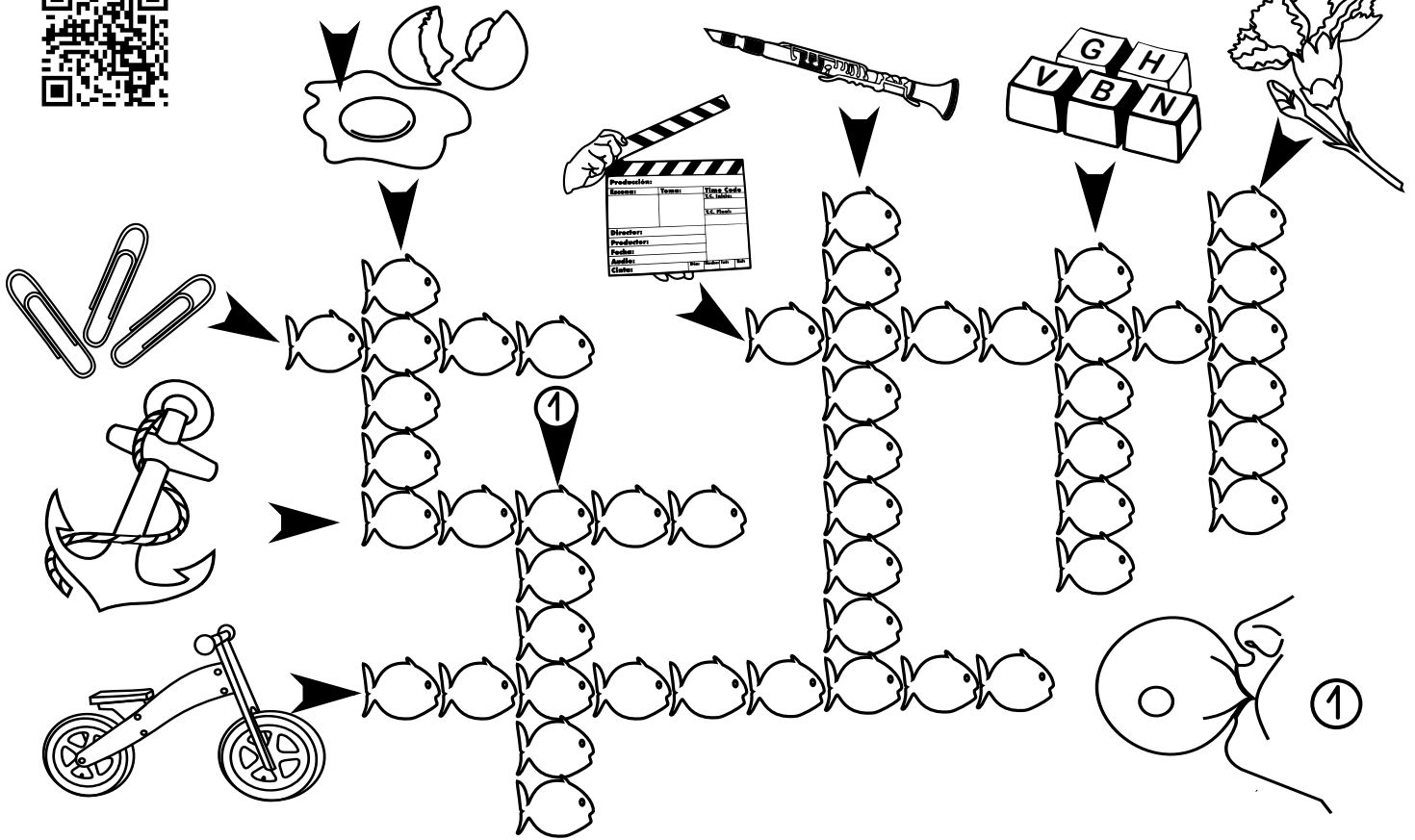

C	C	M	O	T	O	C	R	O	S
R	R	L	C	L	A	R	J	O	C
O	E	C	R	I	C	I	C	M	R
Q	M	R	I	S	R	S	R	B	U
U	A	O	S	R	E	T	I	R	S
E	L	A	A	O	M	O	S	E	T
T	L	S	L	T	A	B	T	R	A
A	E	A	I	N	C	A	A	O	C
S	R	N	D	X	C	L	L	Z	E
G	A	L	A	C	R	A	N	E	O

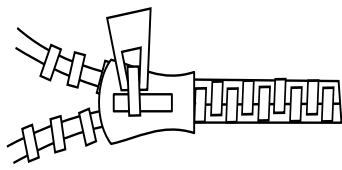
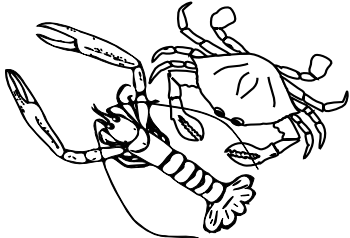
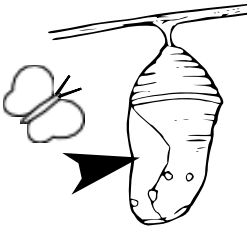
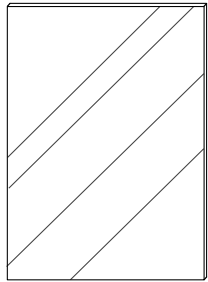
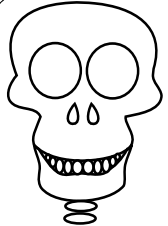
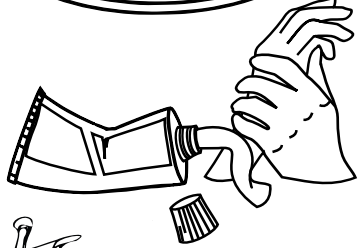
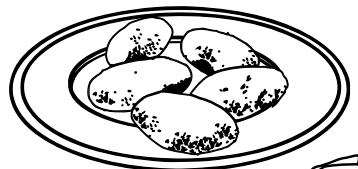

→ _____

→ _____

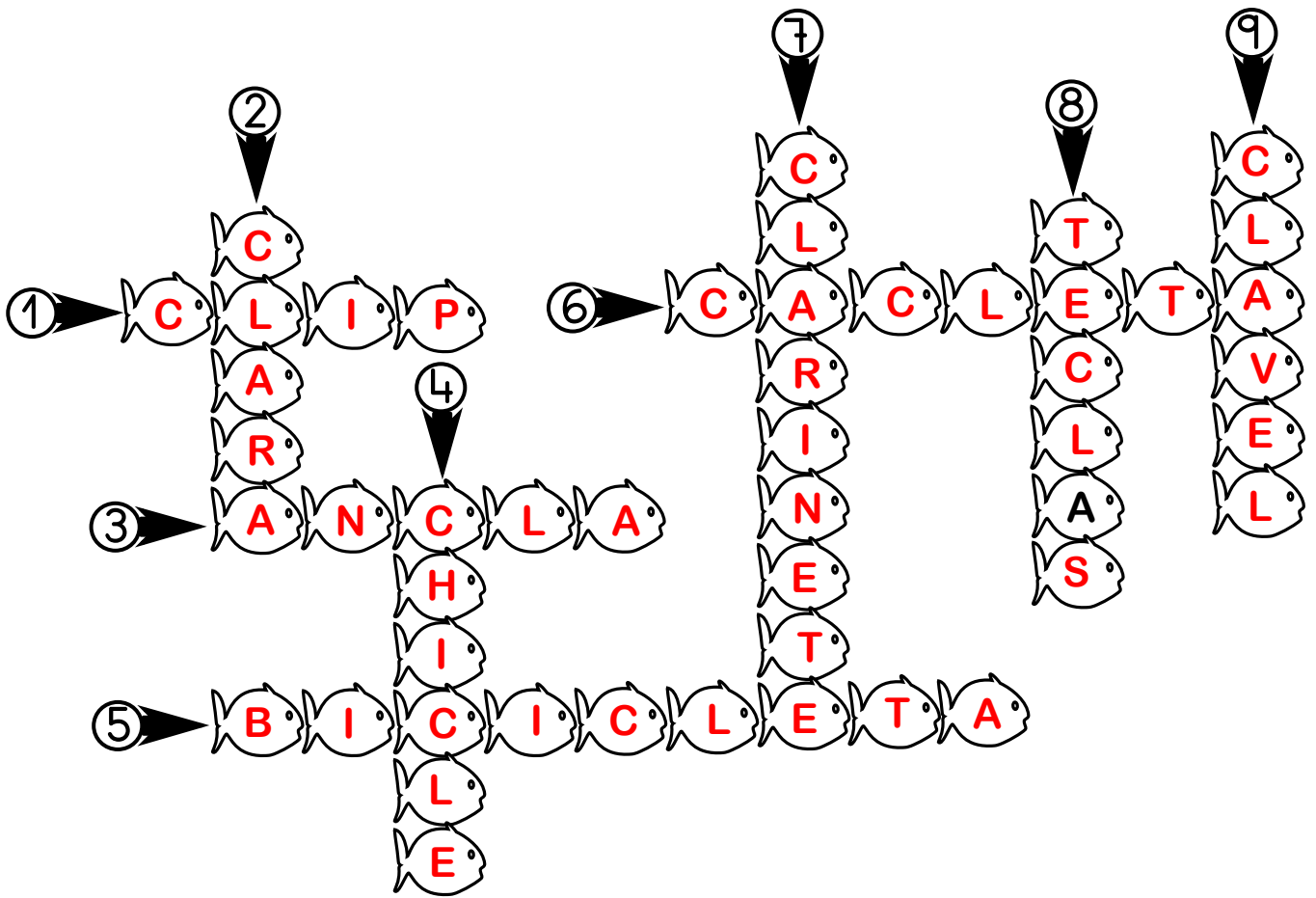

C	C	M	O	T	O	C	R	O	S
R	R	L	C	L	A	R	J	O	C
O	E	C	R	I	C	I	C	M	R
Q	M	R	I	S	R	S	R	B	U
U	A	O	S	R	E	T	I	R	S
E	L	A	A	O	M	O	S	E	T
T	L	S	L	T	A	B	T	R	A
A	E	A	I	N	C	A	A	O	C
S	R	N	D	X	C	L	L	Z	E
G	A	L	A	C	R	A	N	E	O

