

BRAZO

BLAZO

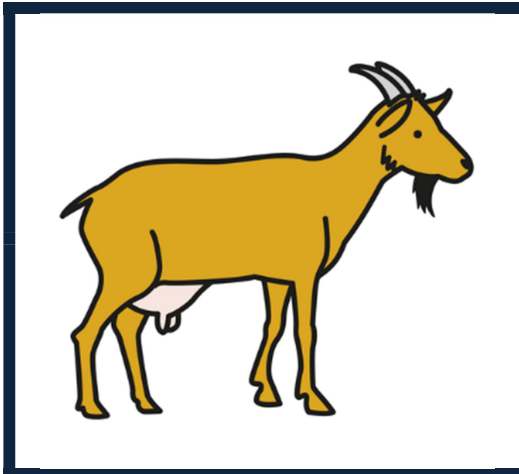

CABLA

CABRA



BRUJA

BURJA

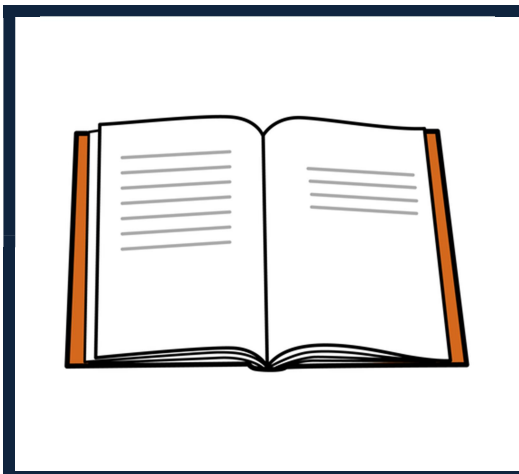

LIBLO

LIBRO

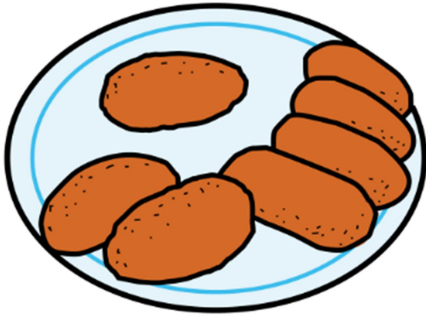

CLOQUETAS

CROQUETAS

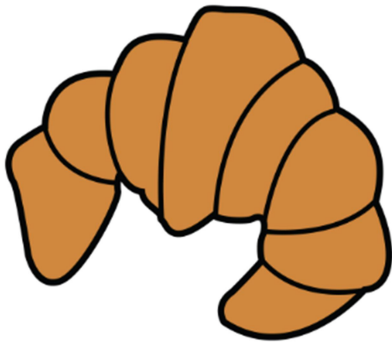

CRUASÁN

CLUASÁN

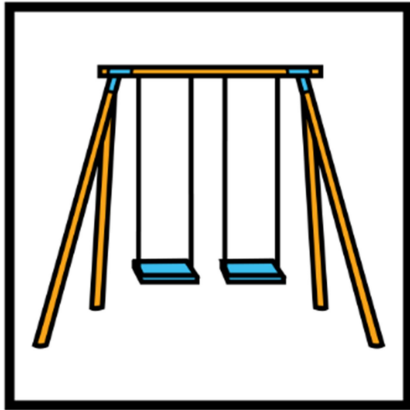

RECLEO

RECREO

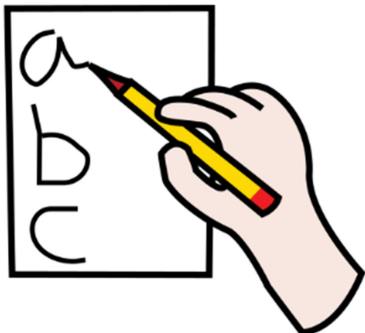

ESCRIBIR

ESCLIBIR

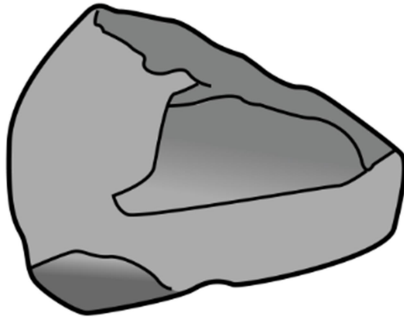

PIEDLA

PIEDRA



CUADRO

CUADLO

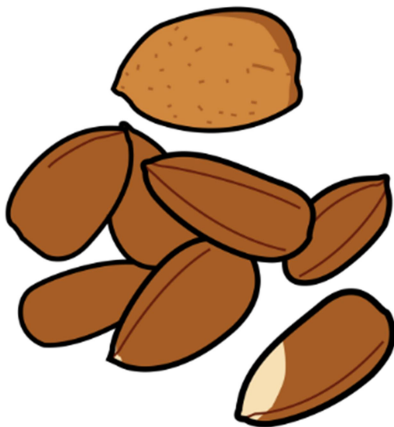

ALMENDRAS

ALMENDLAS

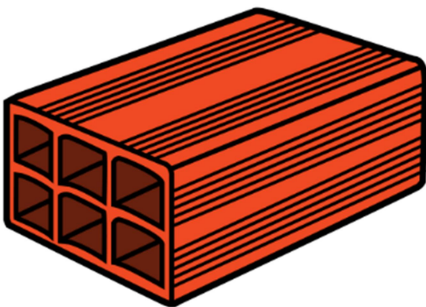

LADLILLO

LADRILLO



FRESA

FLESA



FRÍO

FLÍO



FLUTA

FRUTA



FLEGAR

FREGAR

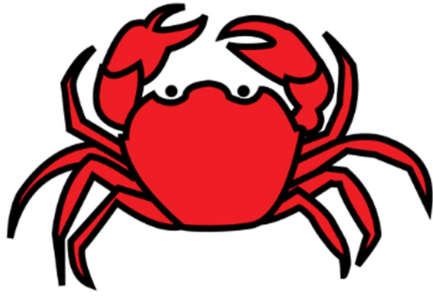

CANGL**E**JO

CANG**R**EJO

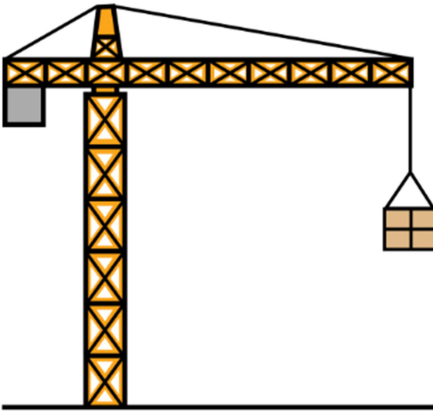

GL**Ú**A

GR**Ú**A



GR**I**FO

GL**I**FO



NE**G**LO

NE**G**RO

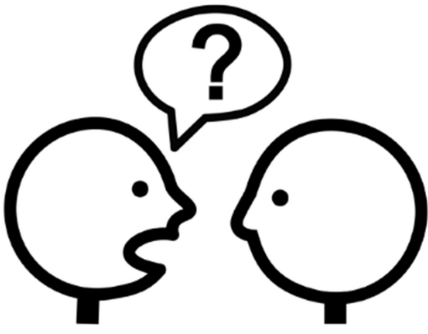

PREGUNTAR

PLEGUNTAR



COMPLAR

COMPRAR

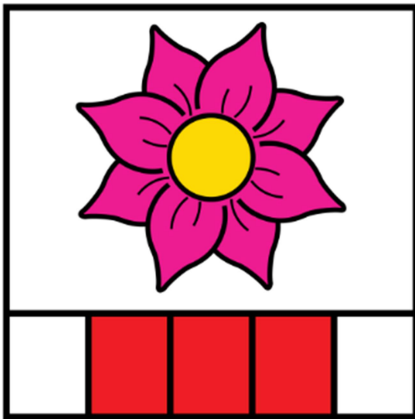

PLIMAVERA

PRIMAVERA

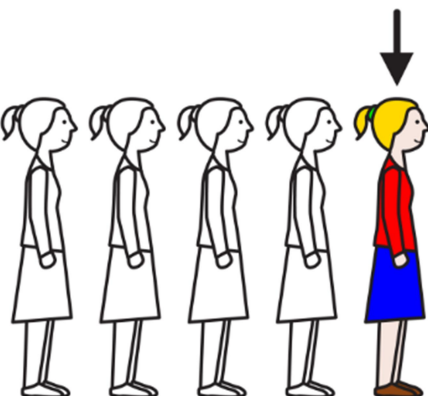

PRIMERA

PLIMERA

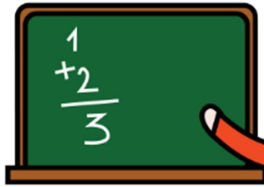

MAESTRA

MAESTLA

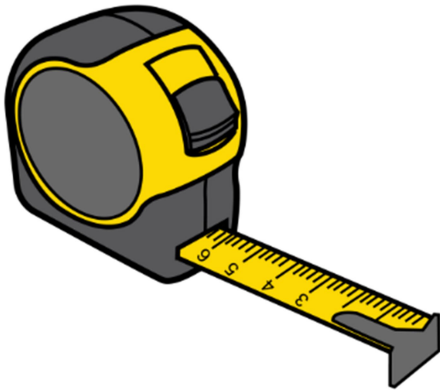

METLO

METRO

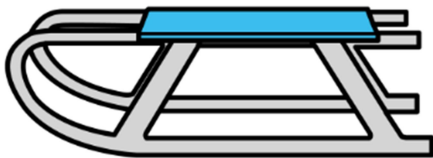

TLINEO

TRINEO



ESTRELLA

ESTLELLA

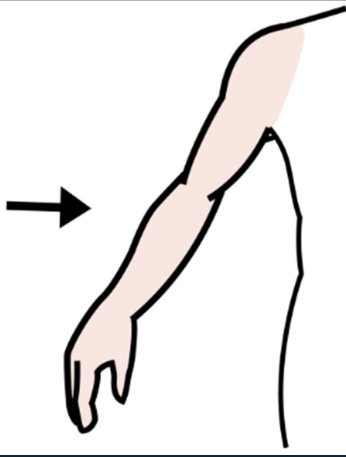

brazo

blazo

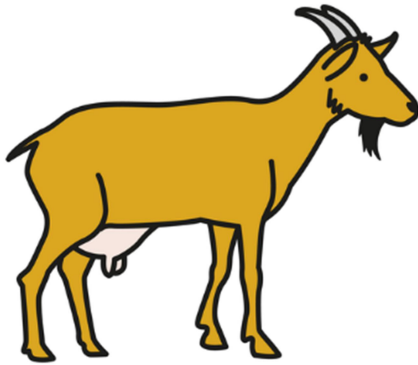

cabla

cabra



bruja

burja

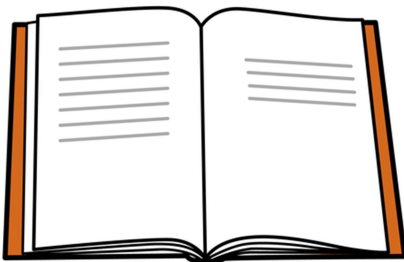

liblo

libro

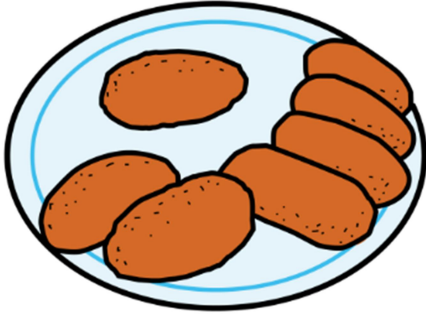

cloquetas

croquetas

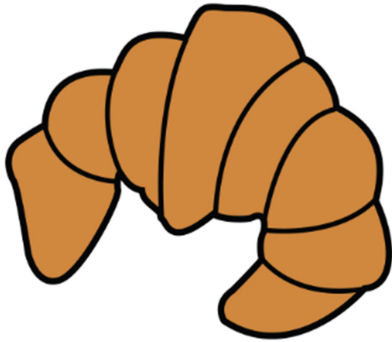

cruasán

cluasán

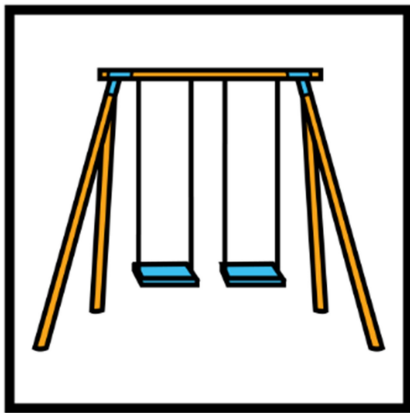

recleo

recreo

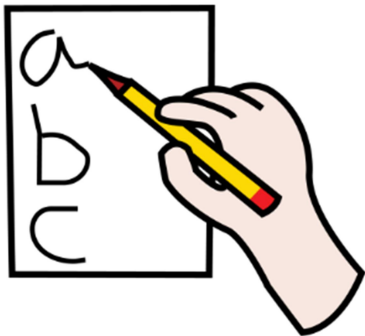

escribir

esclibir



pi**ed**la

pi**ed**ra



cu**ad**ro

cu**ad**lo

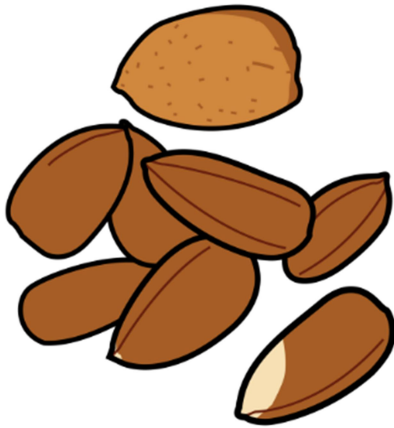

alm**en**dras

alm**en**dras

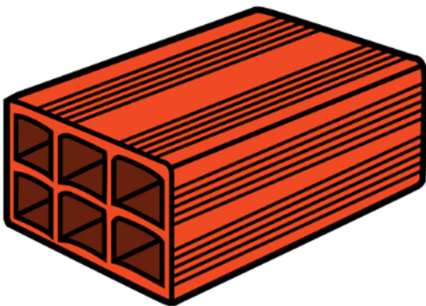

lad**ri**llo

lad**ri**llo



fresa

flesa



frío

flío



fluta

fruta



flegar

fregar

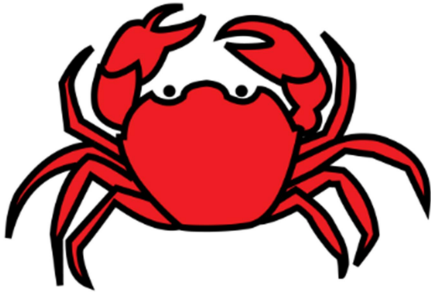

cang*le*jo

cang*re*jo

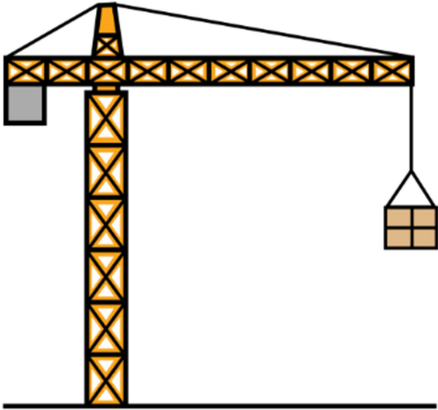

grú*a*

grú*a*



grif*o*

grif*o*



neg*ro*

neg*ro*

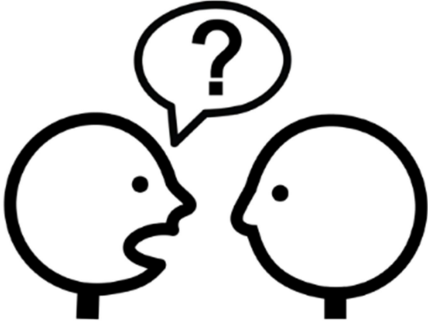

preguntar

preguntar



comprar

comprar

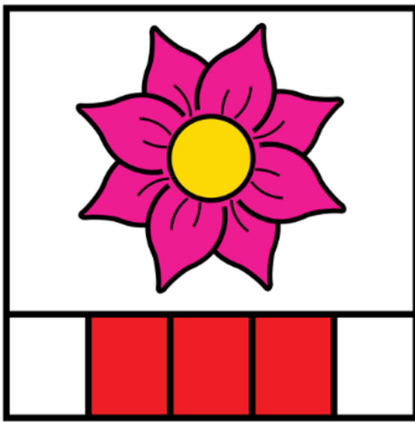

primavera

primavera

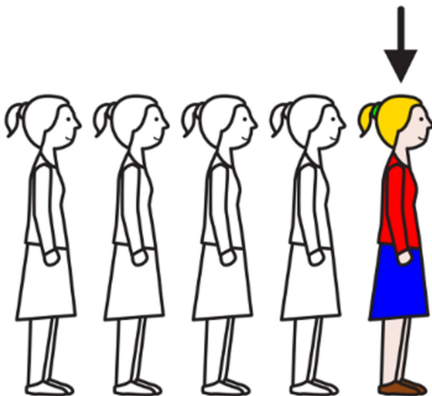

primera

primera



maestra

maestla

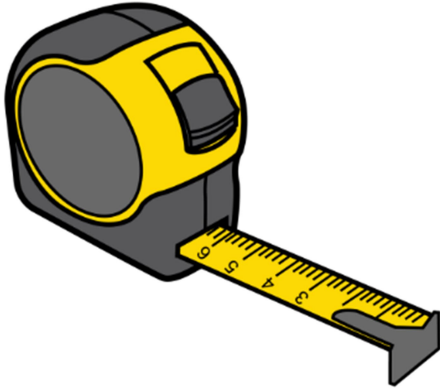

metlo

metro

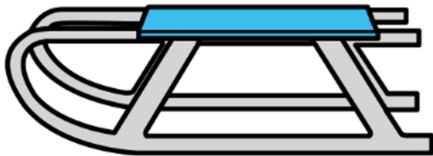

tlineo

trineo



estrella

estlella