

BRAZO

BARZO

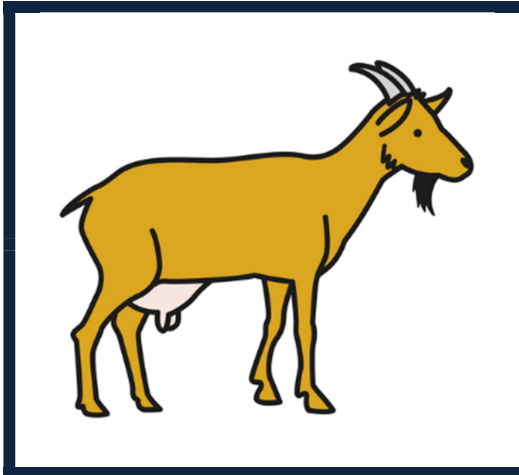

CABAR

CABRA



BRUJA

BURJA

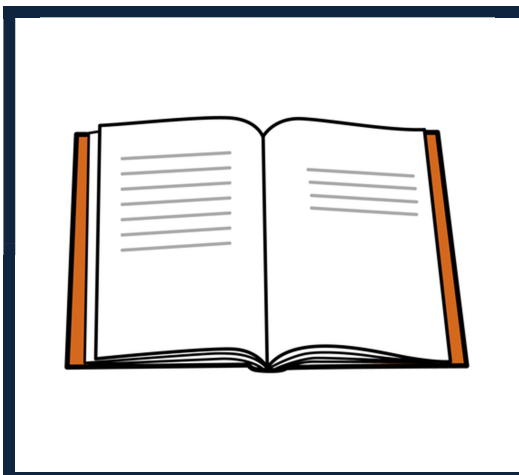

LIBOR

LIBRO

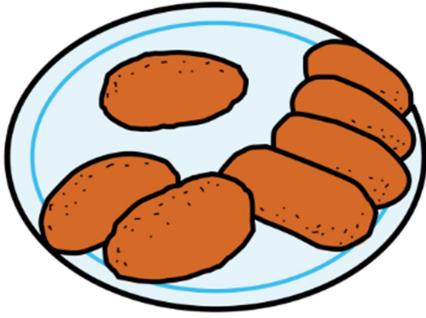

CORQUETAS

CROQUETAS

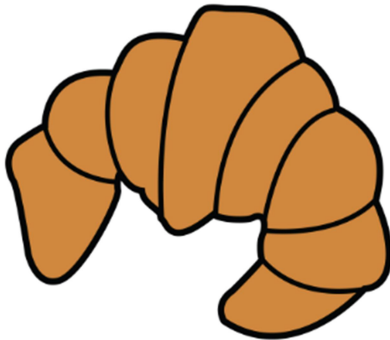

CRUASÁN

CURASÁN



CERMA

CREMA

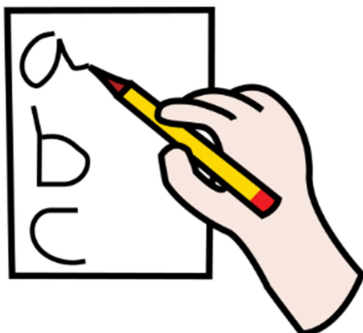

ESCIRBIR

ESCRIBIR

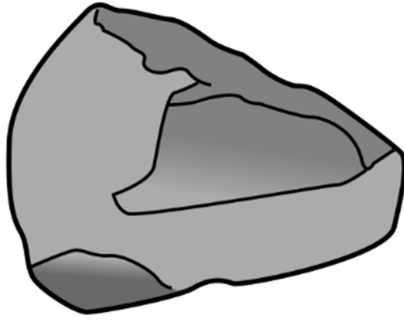

PIEDAR

PIEDRA



CUADRO

CUADOR



DRAGÓN

DARGÓN

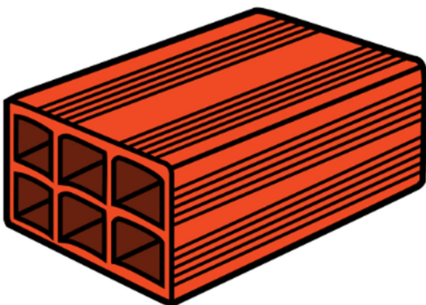

LADIRLLO

LADRILLO

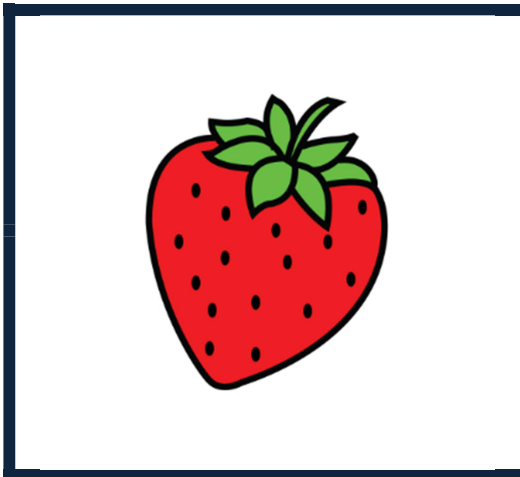

FRESA

FERSA

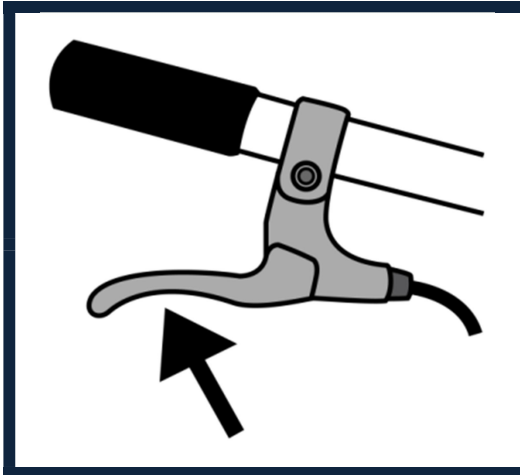

FRENO

FERNO

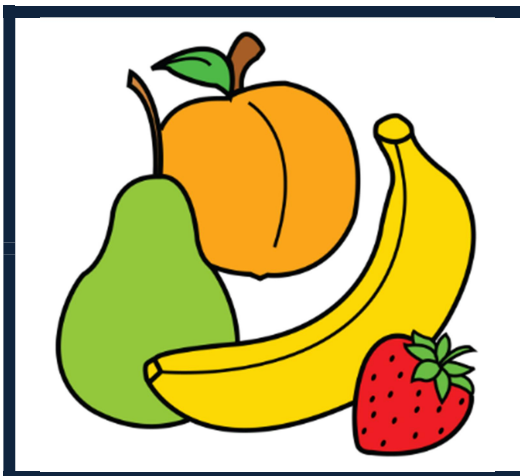

FURTA

FRUTA



FERGAR

FREGAR

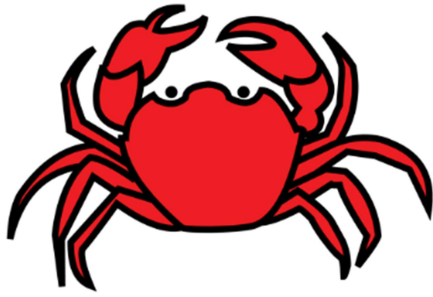

CAN**GER**JO

CAN**GRE**JO



O**GRO**

O**GOR**



GRIFO

GIRFO



NE**GOR**

NE**GRO**

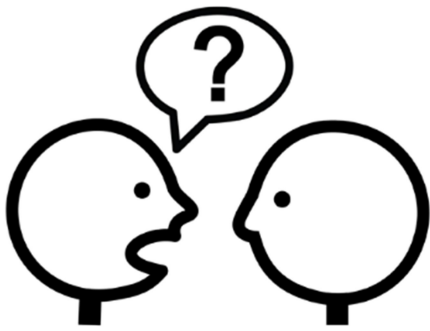

PREGUNTAR

PERGUNTAR



PERMIO

PREMIO

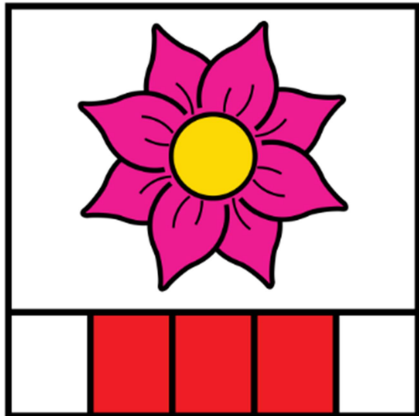

PIRMAVERA

PRIMAVERA

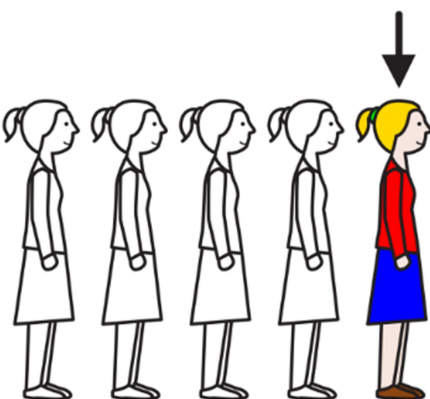

PRIMERA

PIRMERA



MAESTRA

MAESTAR

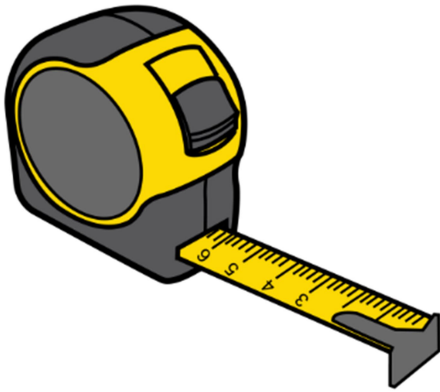

METOR

METRO

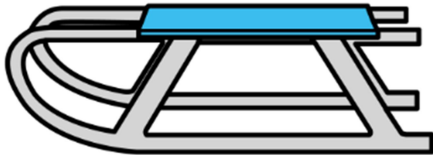

TIRNEO

TRINEO



ESTRELLA

ESTERLLA

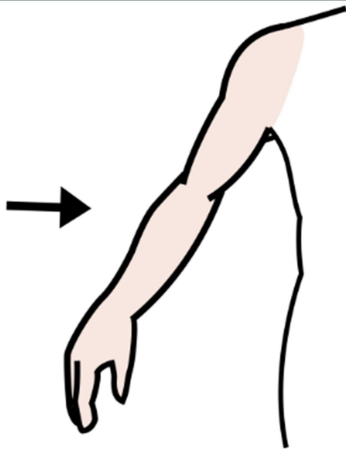

brazo

barzo

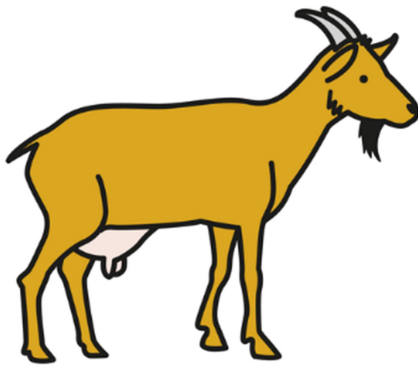

cabar

cabra



bruja

burja



libor

libro

00000000

00000

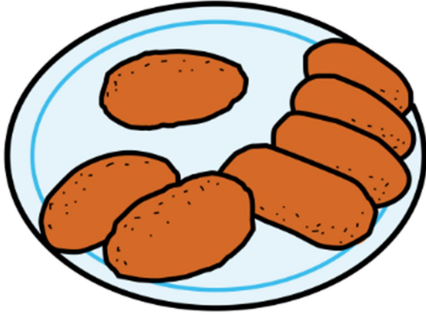

corquetas

croquetas

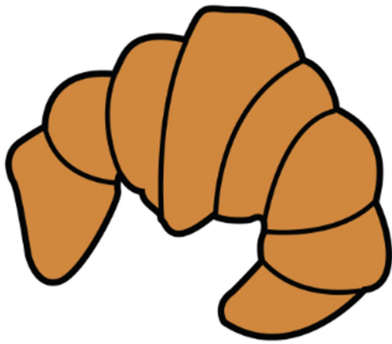

cruasán

curasán



cerma

crema

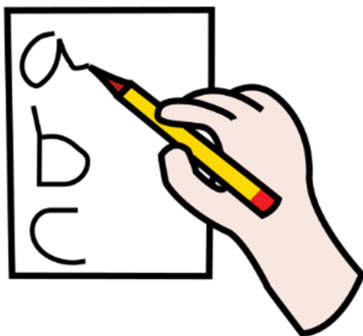

escirbir

escribir

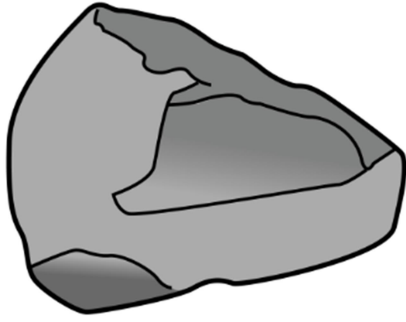

pie**dar**

pie**dra**



cuad**ro**

cuad**or**



drag**ón**

dar**gón**

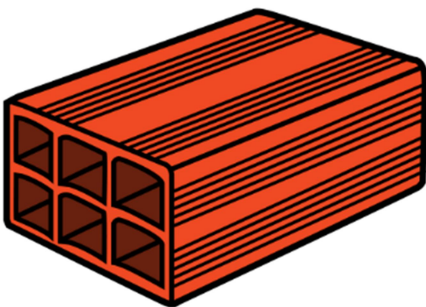

ladir**llo**

ladr**illo**

aaaaaa

aaaaa



fresa

fersa

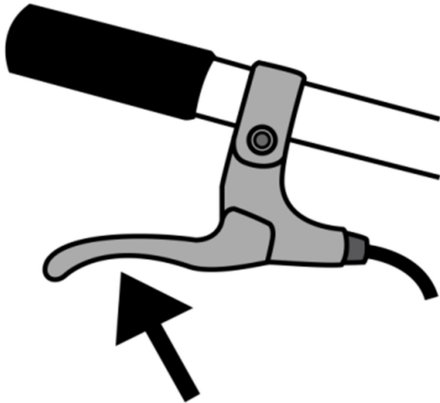

freno

ferno



furta

fruta



fergar

fregar



cangerjo

cangrejo



ogro

ogor



grifo

girfo



negor

negro

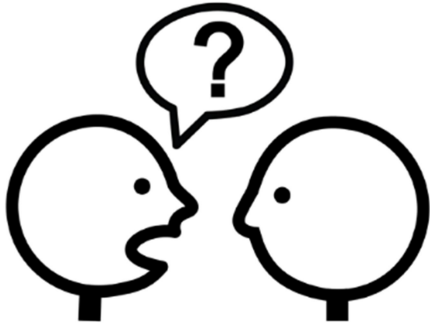

preguntar

perguntar



permio

premio

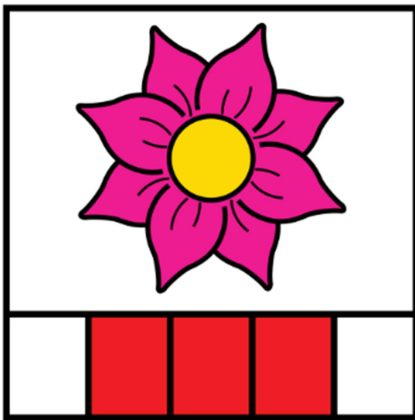

pirmavera

primavera

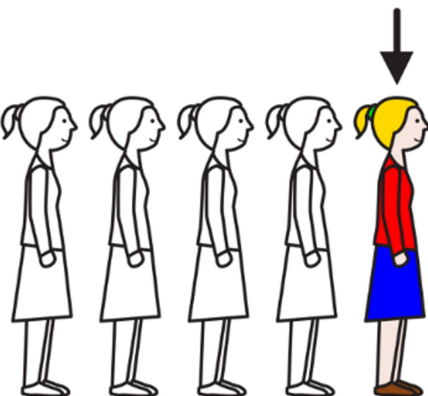

primera

pirmera



maestra

maestar

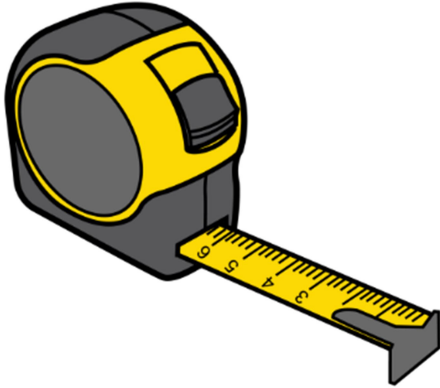

metor

metro

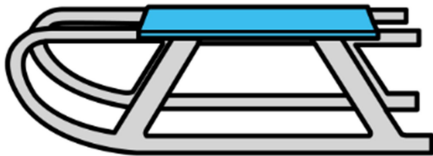

tirneo

trineo



estrella

esterlla