

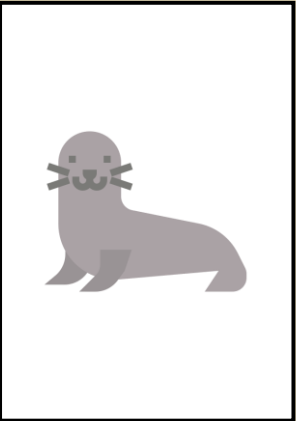



Colorea una silaba de cada columna para formar la palabra:





fo	pa
ro	ca
jo	sa

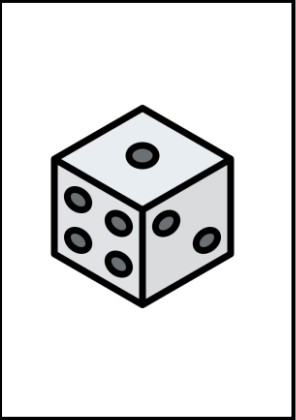

ce	ta
re	za
se	ka



da	bo
ba	po
pa	do



be	no
le	ón
de	or





Colorea una silaba de cada columna para formar la palabra:



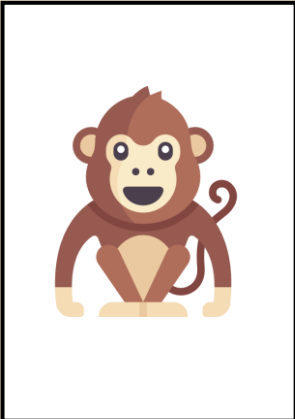

pi	lla
si	ma
ci	ja

\_\_\_\_\_





mo	so
wo	zo
vo	no

\_\_\_\_\_



no	gue
xo	che
co	he

\_\_\_\_\_



lu	sa
ju	na
hu	va



\_\_\_\_\_





Colorea una silaba de cada columna para formar la palabra:

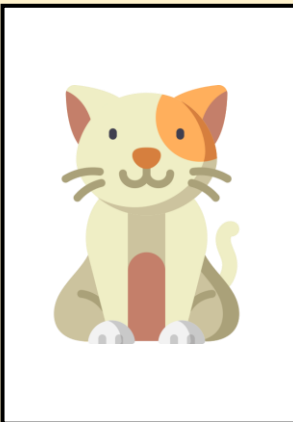



gue	so
que	co
hue	zo



ga	po
pa	to
fa	ho

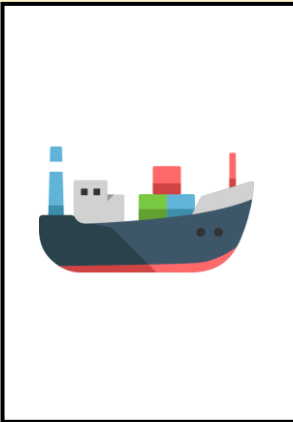

ta	ci
sa	ni
na	xi



bra	co
bar	bo
fa	no





Colorea una silaba de cada columna para formar la palabra:





lo	co
to	do
bo	ro

[Empty box for the word]





in	la
il	ta
is	ba

[Empty box for the word]

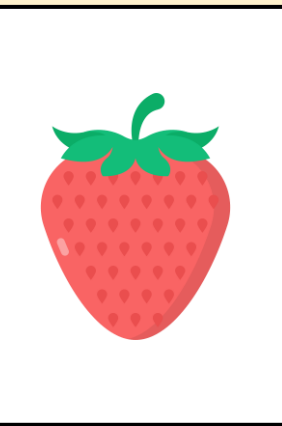

lla	ne
ba	ve
ta	ce

[Empty box for the word]



pre	za
tre	sa
fre	na

[Empty box for the word]



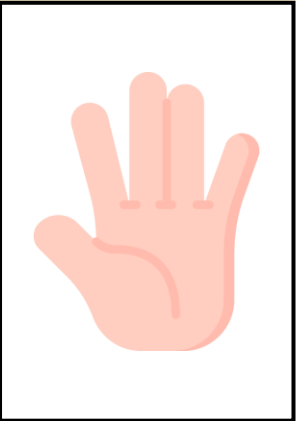

Colorea una silaba de cada columna para formar la palabra:





ma	xo
ba	fo
za	no

\_\_\_\_\_



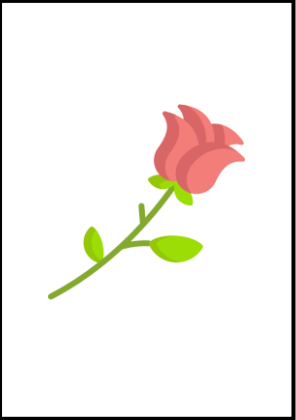

be	tro
de	rro
pe	gro

\_\_\_\_\_



ro	sa
no	ta
co	ja

\_\_\_\_\_



bi	bro
di	pro
li	bor

\_\_\_\_\_

