

MI CUADERNILLO DE REPASO

5 AÑOS



★ Nombre: _____

♥ Clase: _____

Vocales • Números • Cantidades • Tamaños • Colores • Formas



1

La vocal A



1. Repasa la vocal.

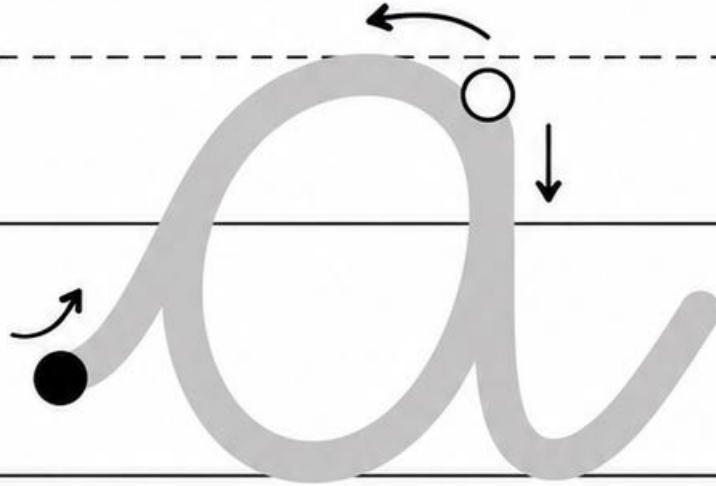

2. Rodea la A.

A a O e A a i A

3. Colorea los dibujos que empiezan por A.

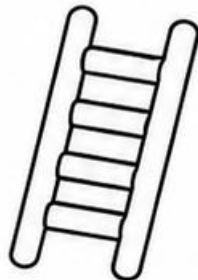
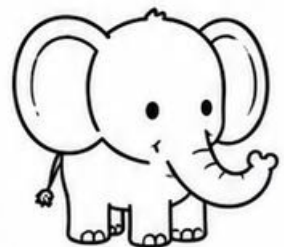
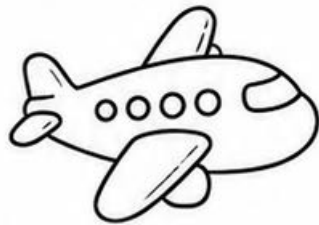

2

La vocal E

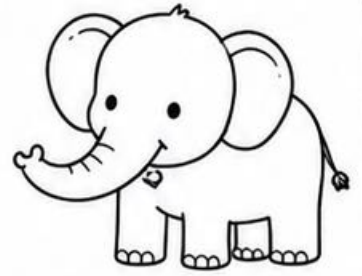

1. Repasa la vocal.

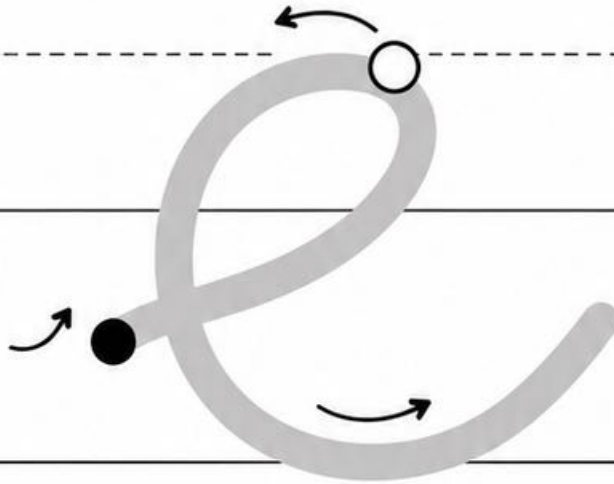

2. Rodea la E.

e E a e i E o e E u

3. Colorea los dibujos que empiezan por E.

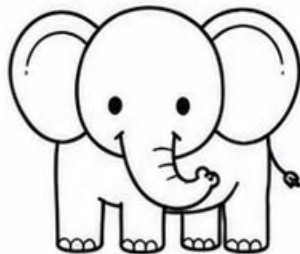

3

La vocal I



1. Repasa la vocal.

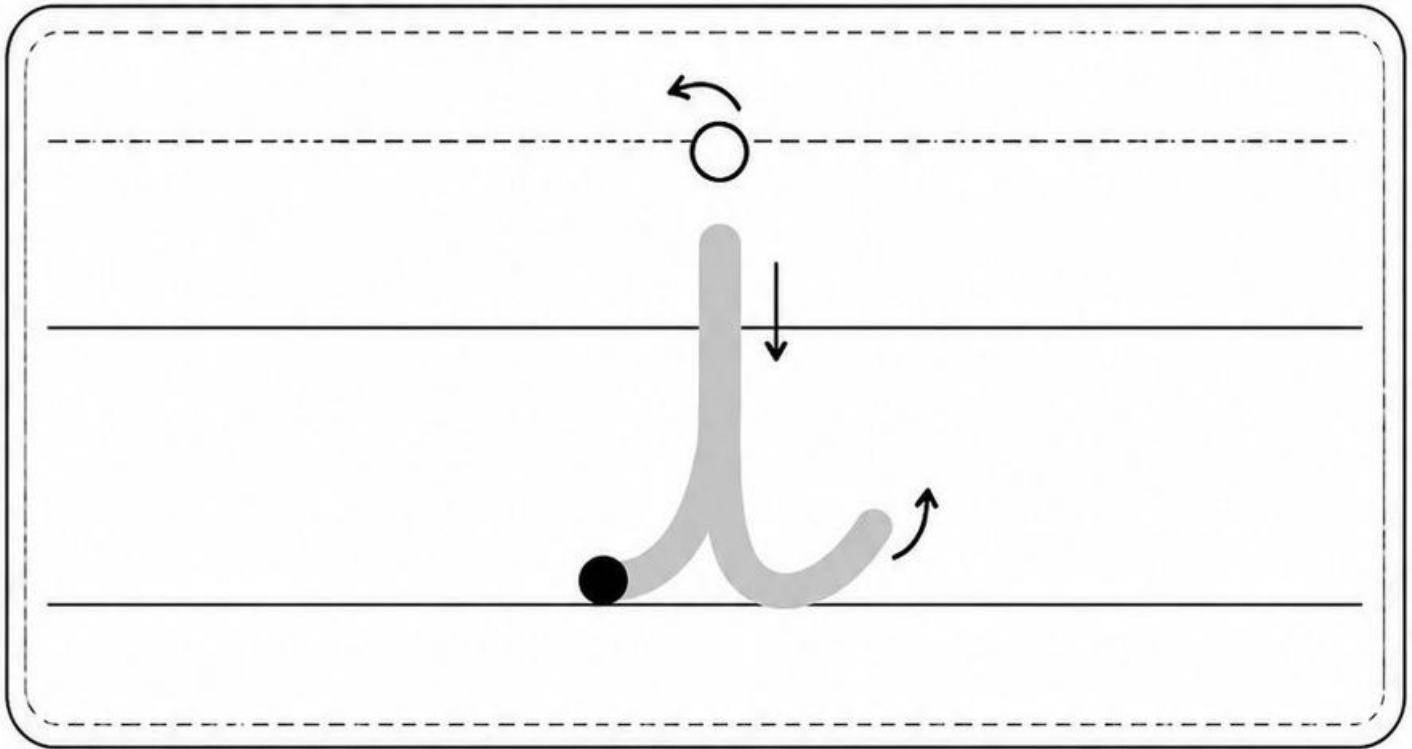

2. Rodea la I.

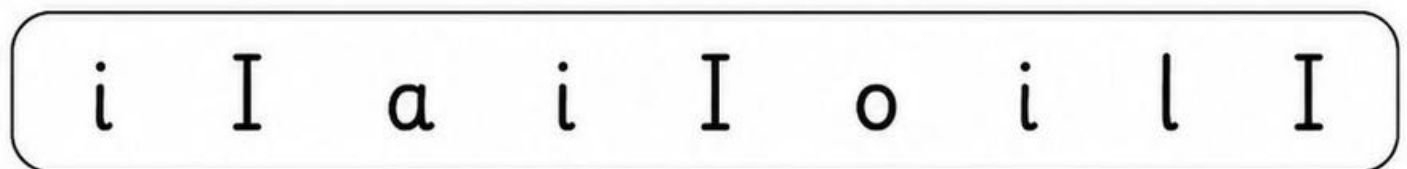

3. Colorea los dibujos que empiezan por I.

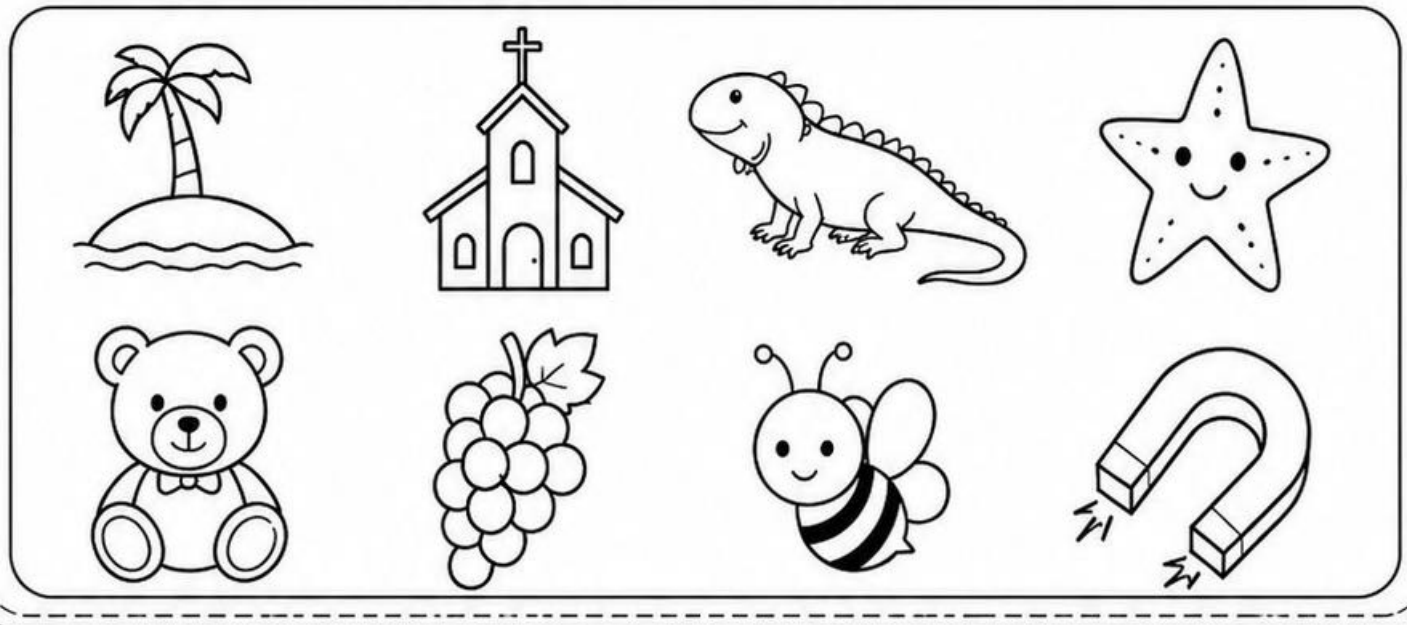

4

La vocal o



1. Repasa la vocal.

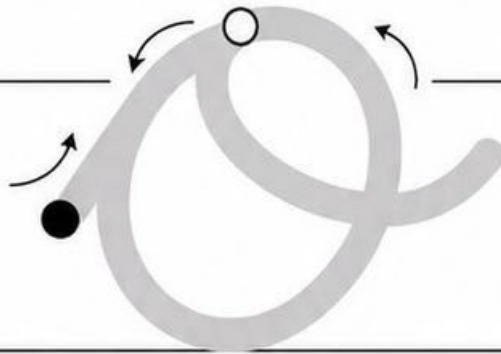

2. Rodea la o.

o O a o O e o i O u o

3. Colorea los dibujos que empiezan por o.

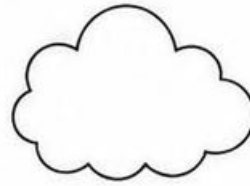
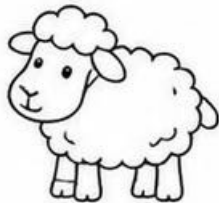
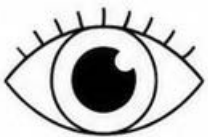

5

La vocal u



1. Repasa la vocal.

Tracing practice area with a large lowercase 'u' on a set of three horizontal lines. The letter is light gray. A black dot at the bottom left of the letter has a curved arrow pointing upwards and to the right, indicating the starting point and direction of the stroke. Two vertical arrows point downwards from the top of the letter, indicating the direction of the second stroke.

2. Rodea la u.

A row of letters for a coloring activity: u U a u I u o U e U u

3. Colorea los dibujos que empiezan por u.

A collection of eight line drawings for coloring, arranged in two rows of four. The first row contains a unicorn, a bunch of grapes, a house, and a star. The second row contains a bear, an umbrella, a hand with the index finger pointing up, and the number 1.





TRAZA EL CILÍNDRO

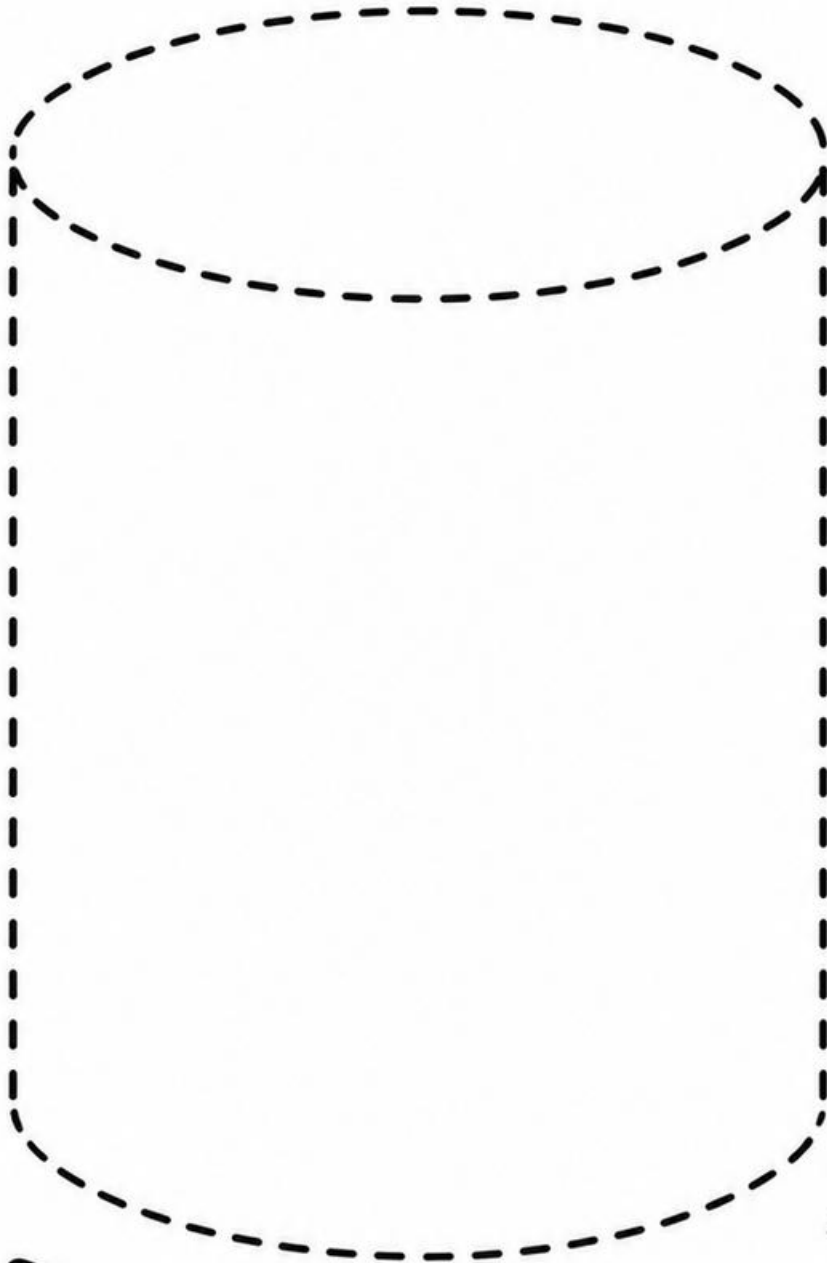



TRAZA EL CUBO

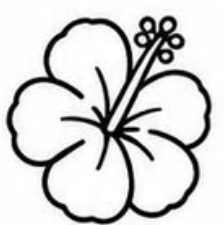
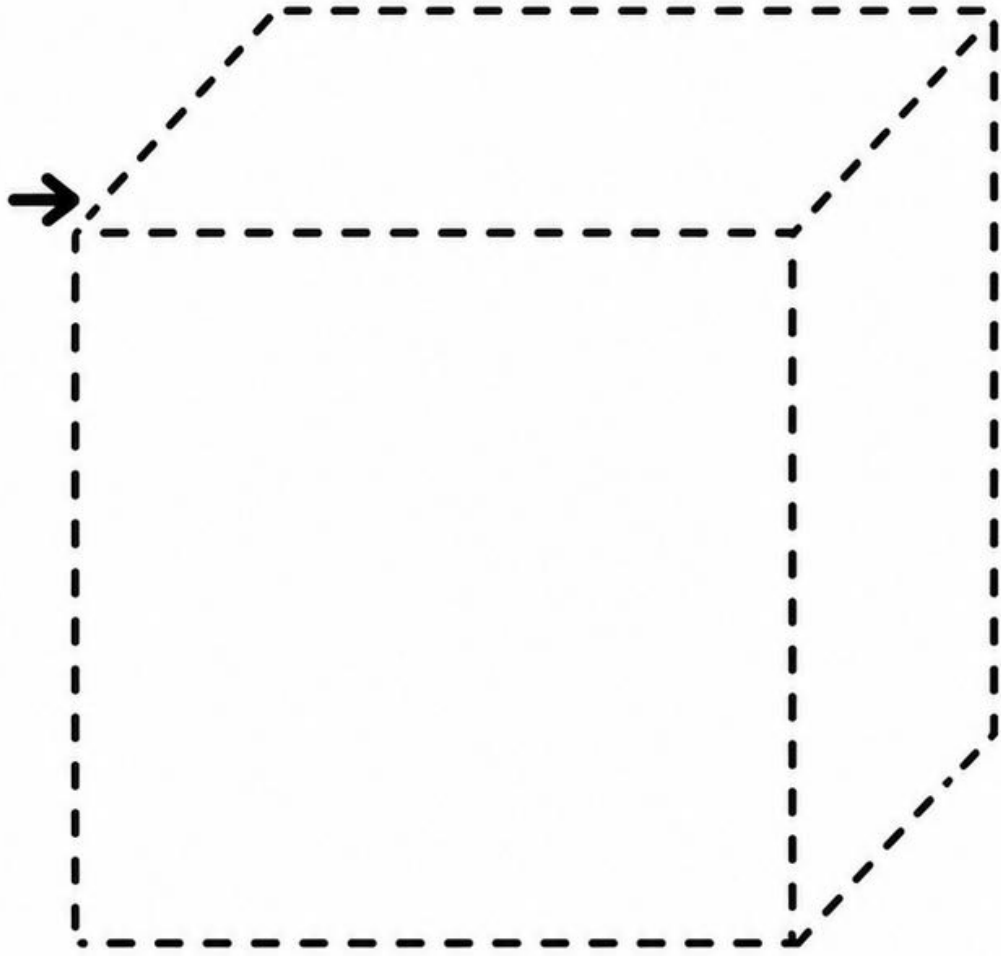
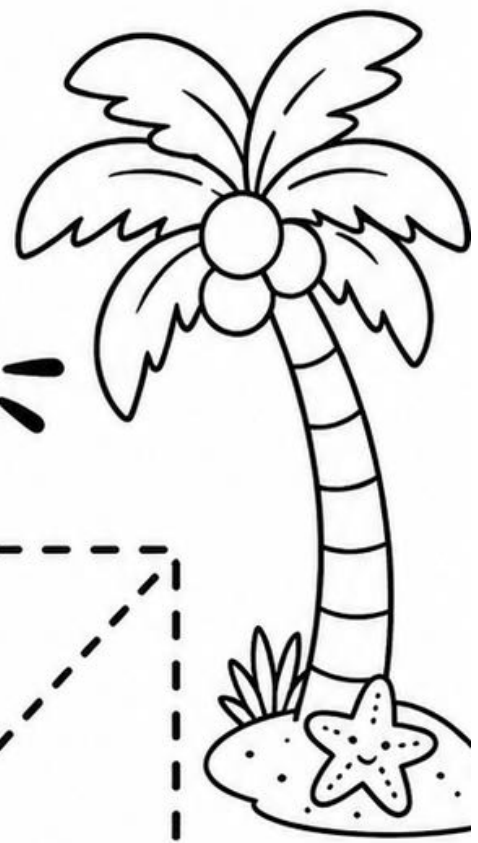

REPASO DE VERANO: EL NÚMERO 11

11



11

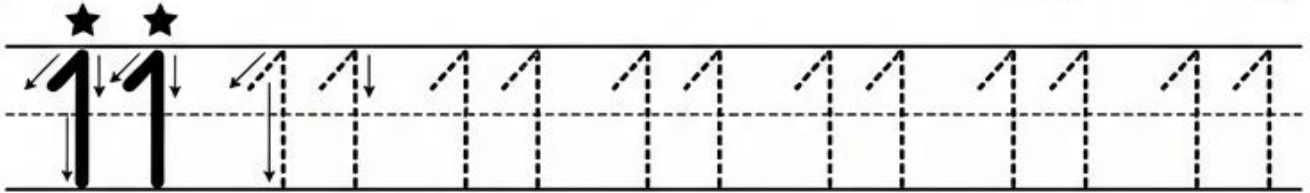
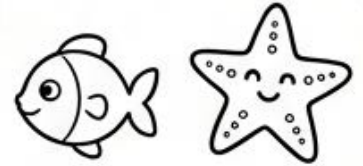
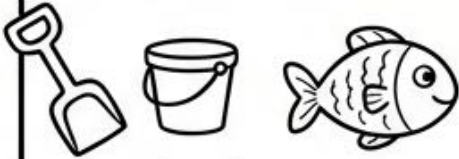
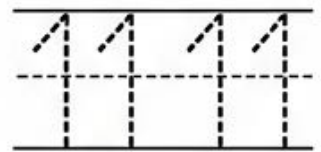
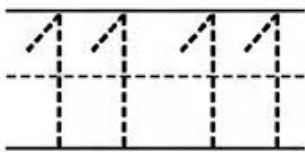
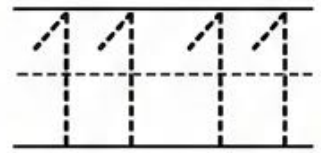
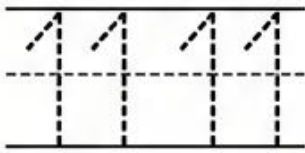

★ ¡CUENTA Y PINTA! ★

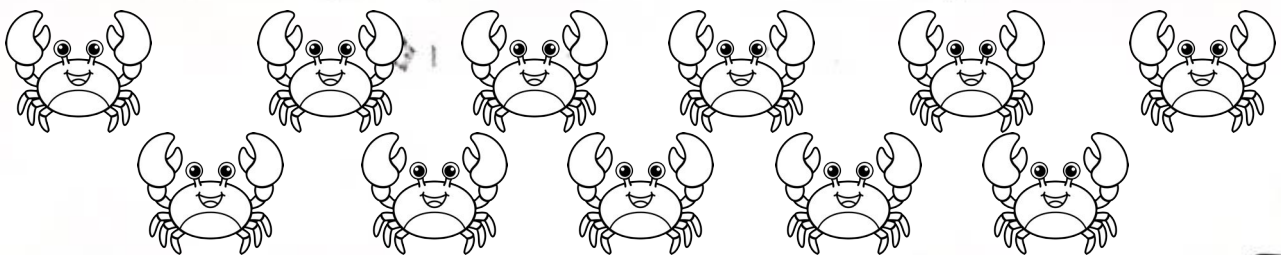

REPASO DE VERANO: EL NÚMERO 12

12

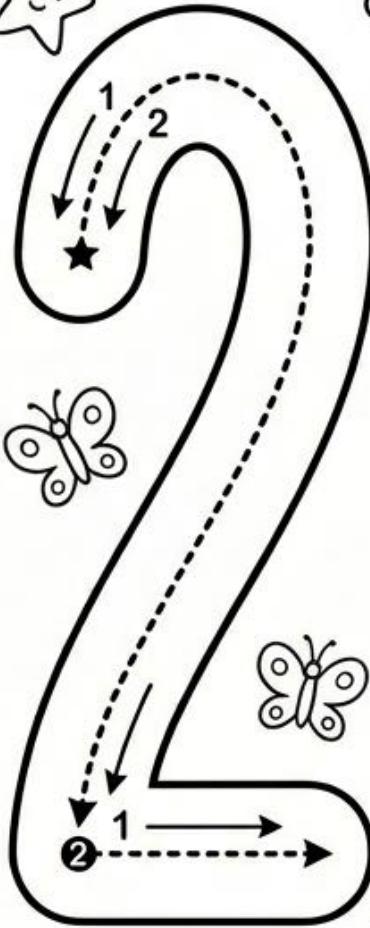
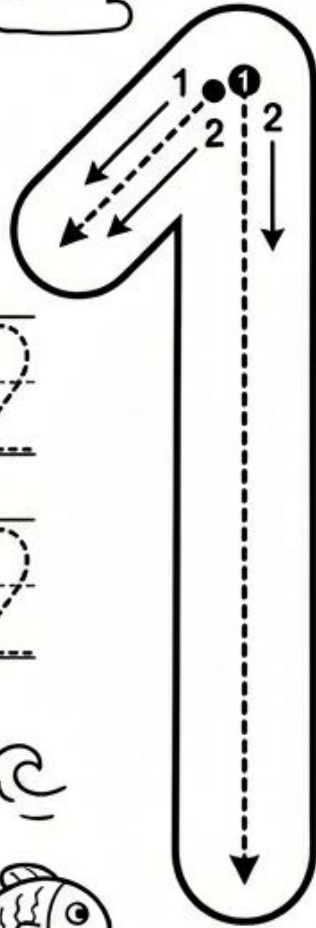

12 12

12 12

12 12

12 12

12 12

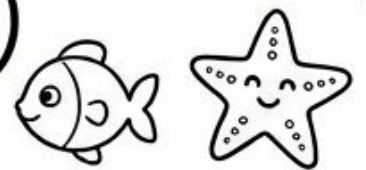

12 12 12 12 12 12 12

★ ¡CUENTA Y PINTA! ★



REPASO DE VERANO: EL NÚMERO 13

13

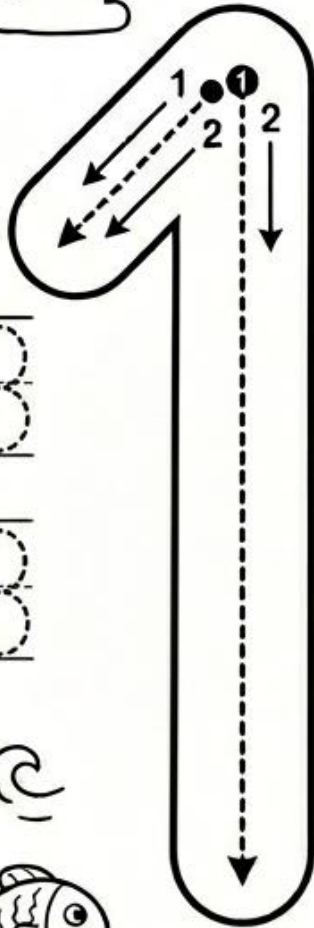

13 13

13 13

13 13

13 13

13 13



13 13 13 13 13 13 13

★ ¡CUENTA Y PINTA! ★

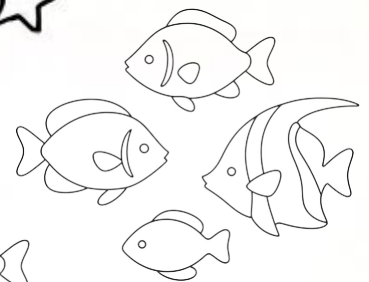
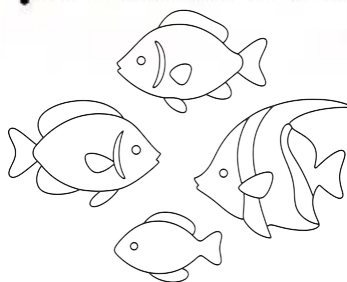
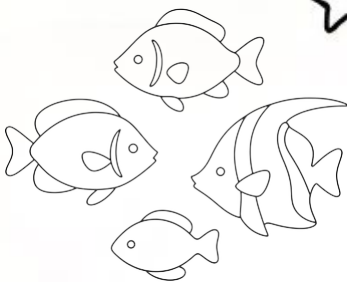

REPASO DE VERANO: EL NÚMERO 14

14

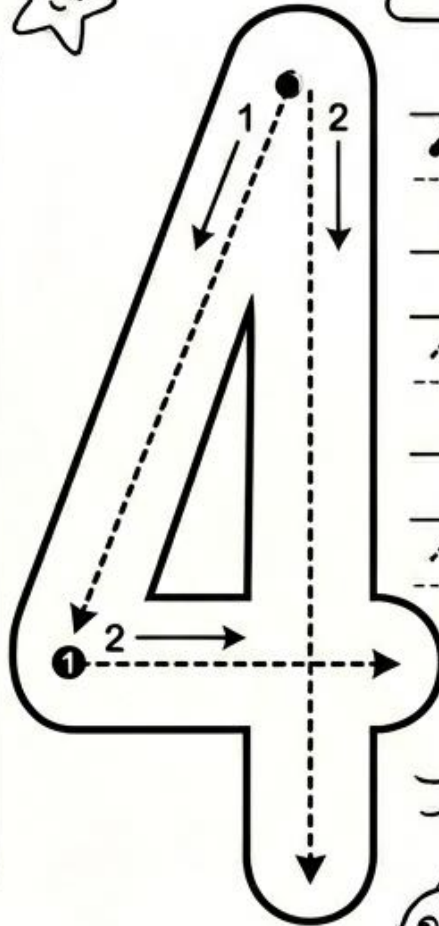
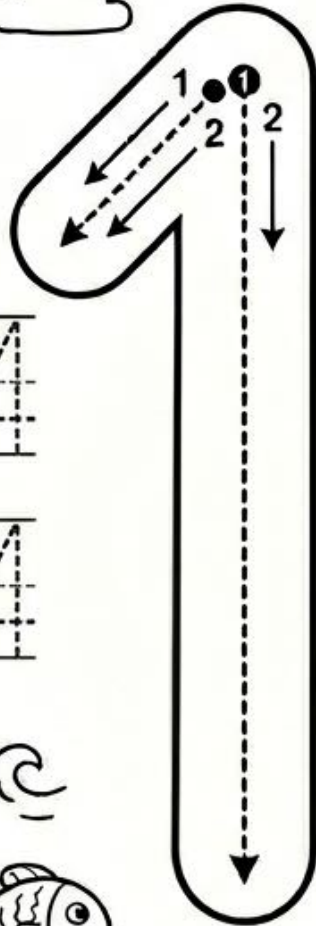

14

14 14

14 14

14 14

14 14

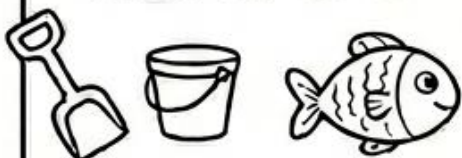

14 14 14 14 14 14 14

★ ¡CUENTA Y PINTA! ★

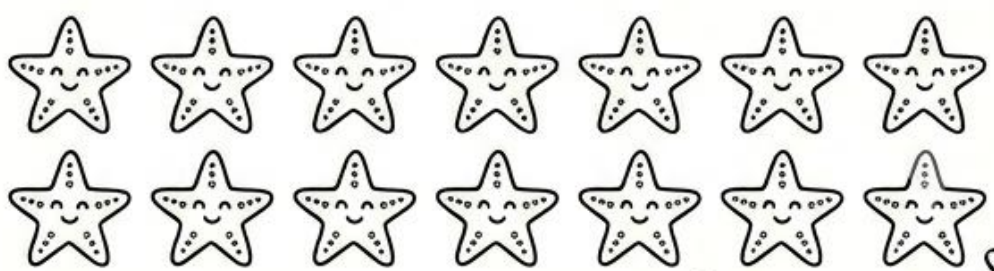

REPASO DE VERANO: EL NÚMERO 15

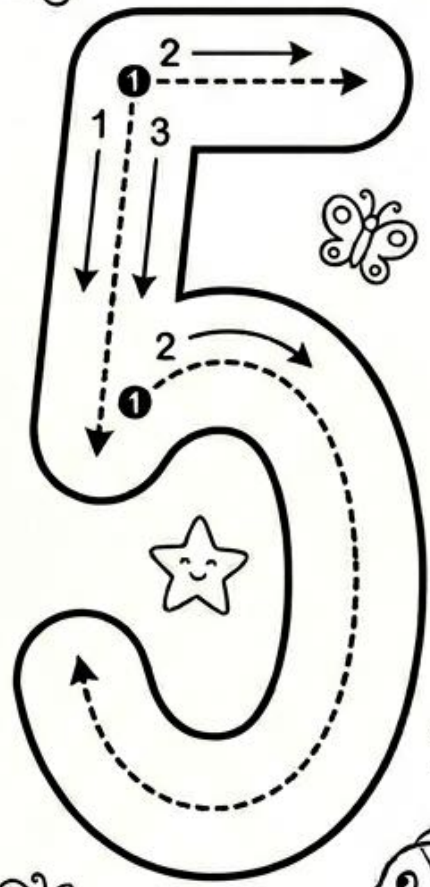
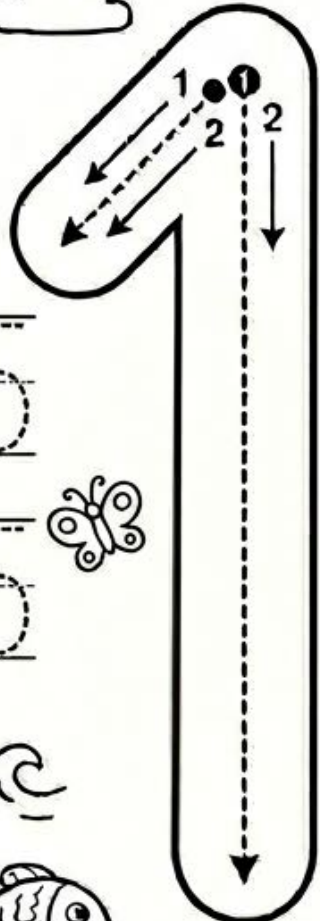

15

15

15 15

15

15 15

15

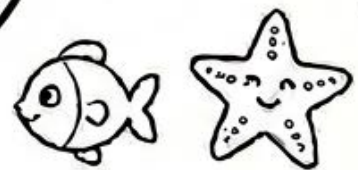
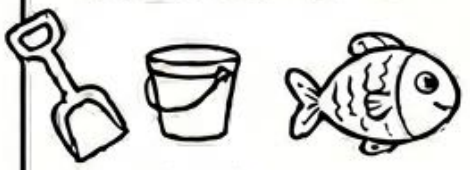

15 15 15 15 15 15 15

★ ¡CUENTA Y PINTA! ★

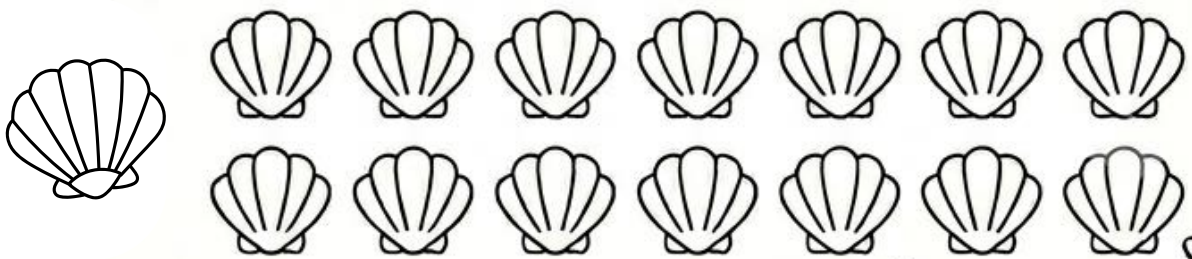

REPASO DE VERANO: EL NÚMERO 16

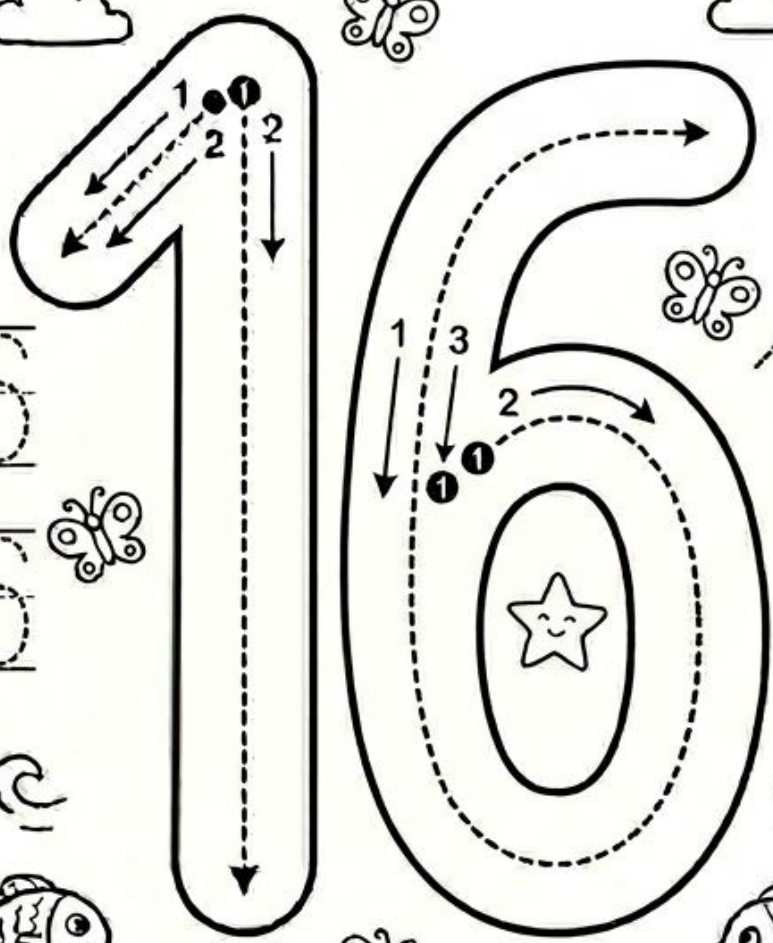

16

16

16 16

16 16

16 16

16

16 16 16 16 16 16 16

★ ¡CUENTA Y PINTA! ★

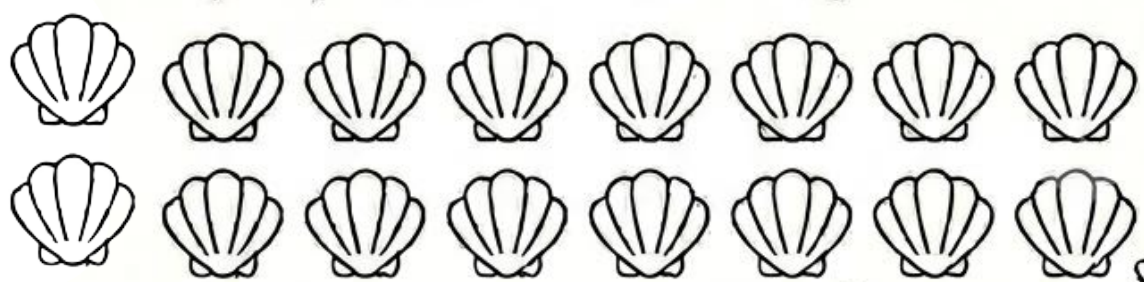

REPASO DE VERANO: EL NÚMERO 17

17

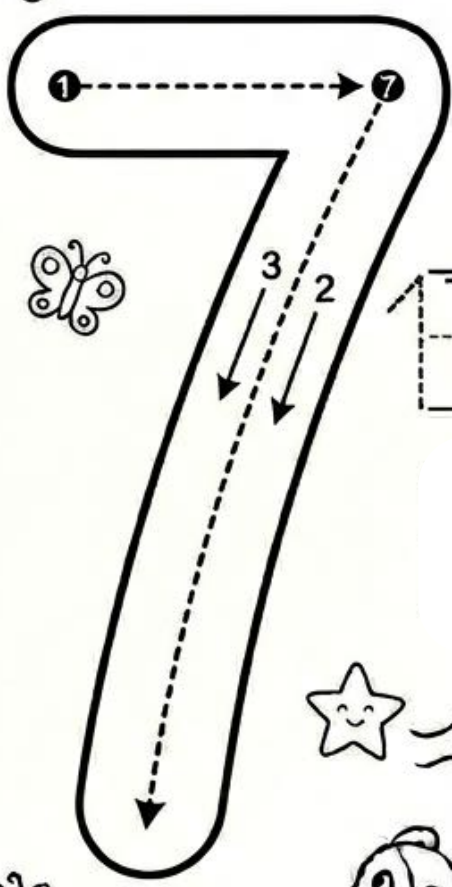
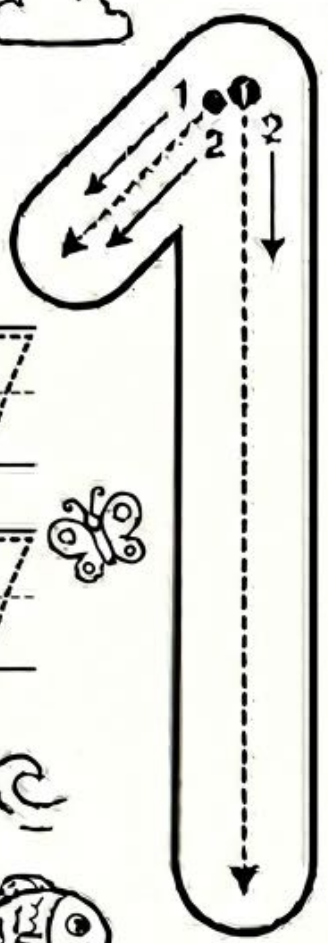

17

17

17

17

17

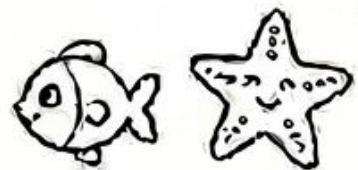
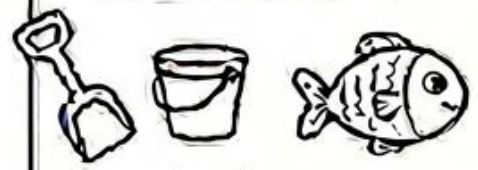

17 17 17 17 17 17 17 17

★ ¡CUENTA Y PINTA! ★

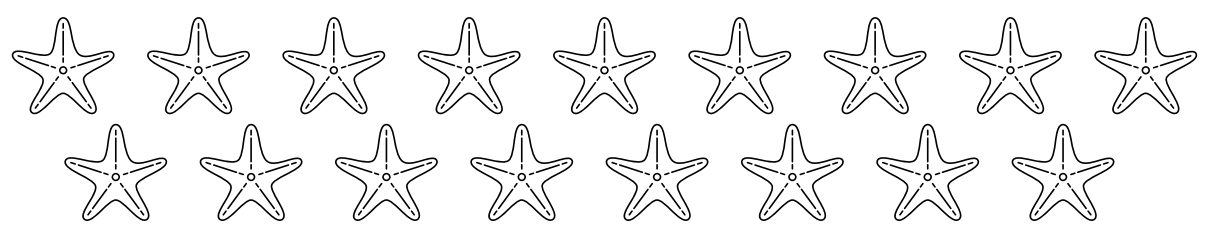

REPASO DE VERANO: EL NÚMERO 18

18

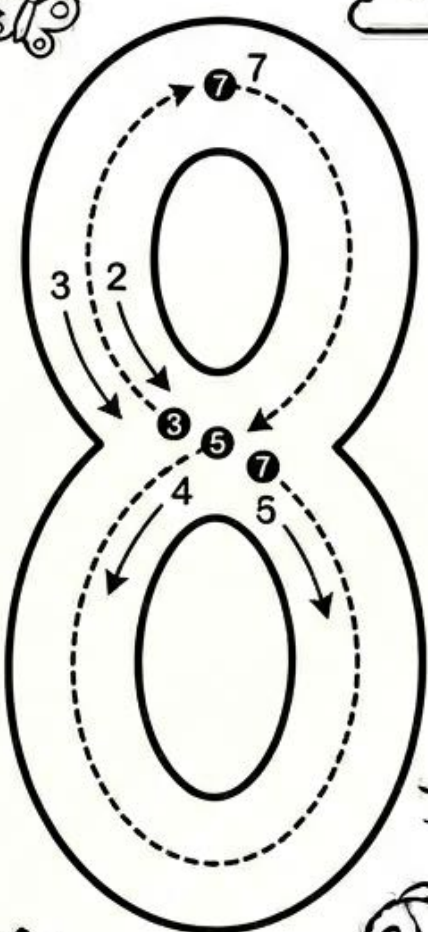
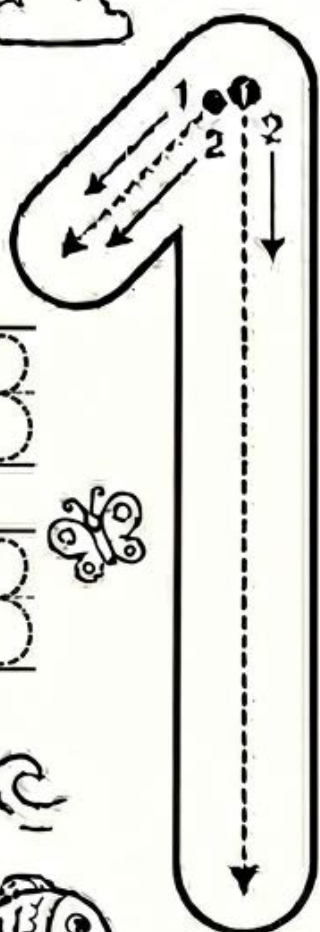

18

18 18

18

18 18

18

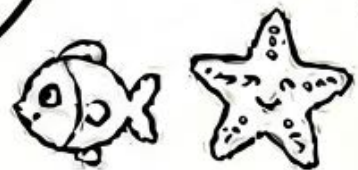
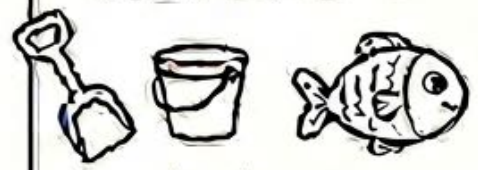

18 18 18 18 18 18 18

★ ¡CUENTA Y PINTA! ★

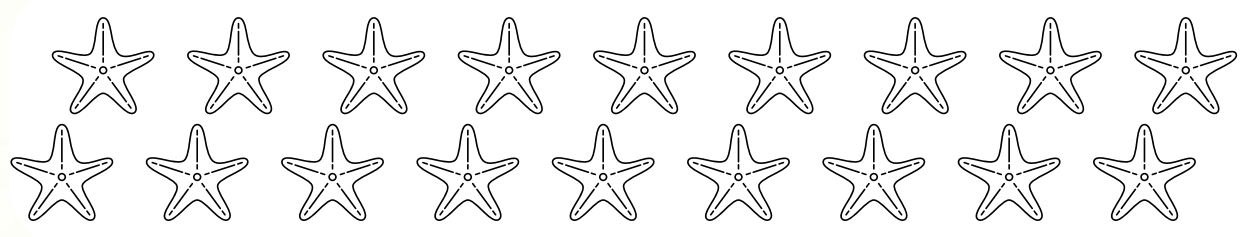

REPASO DE VERANO:

EL NÚMERO 19

19

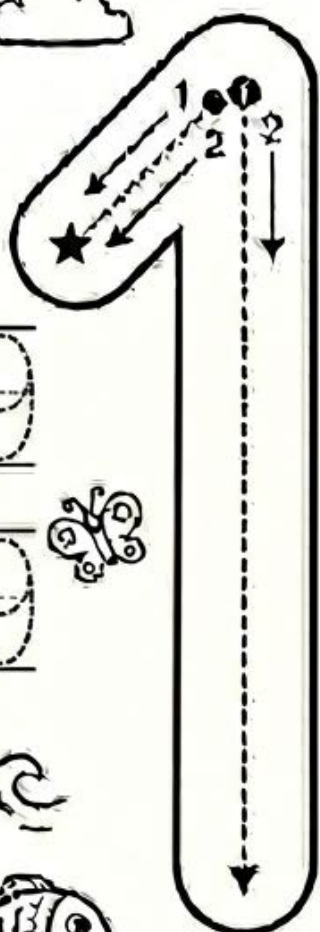

19

19 19

19

19 19

19

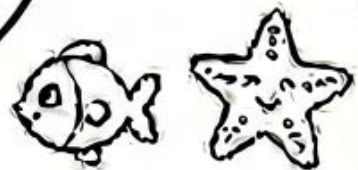
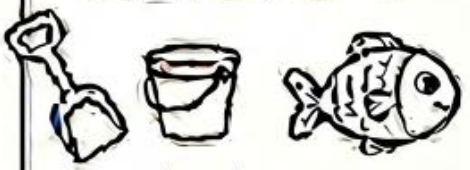

19 19 19 19 19 19 19

★ ¡CUENTA Y PINTA! ★

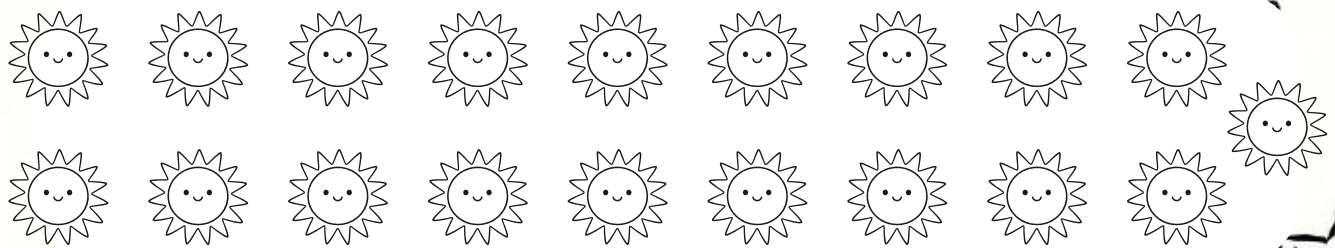

REPASO DE VERANO:
¡TRAZA EL 20!

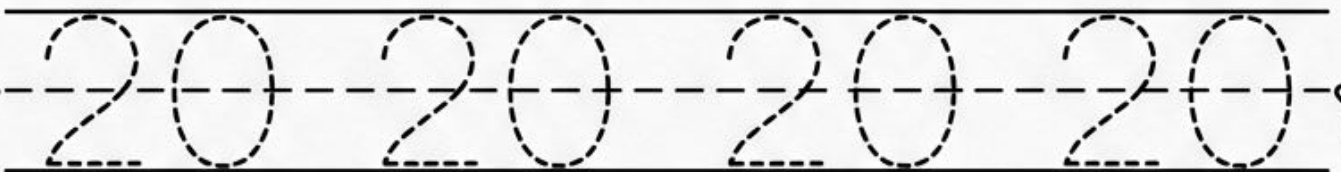
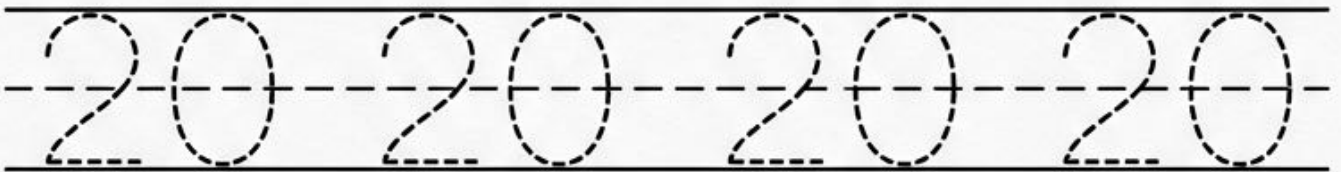
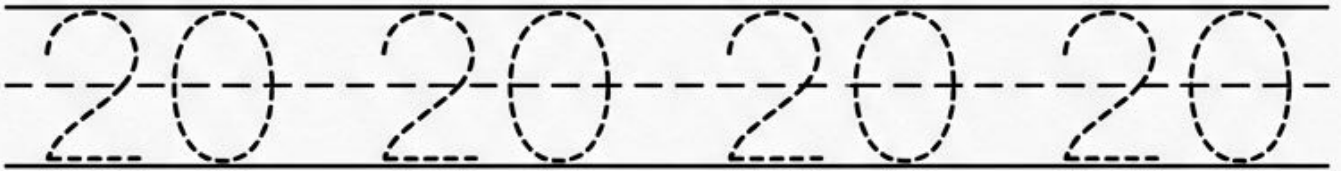

20

¡FELIZ VERANO!



NOMBRE: _____



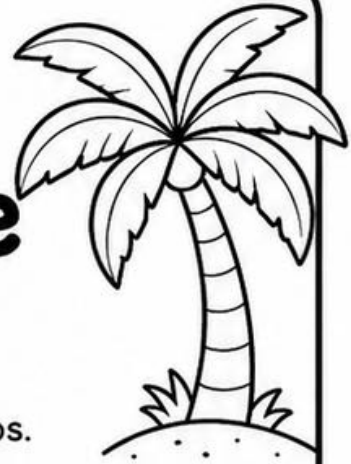

Completa la serie

Series de 3 elementos

Observa el patrón y completa los últimos 3 espacios.

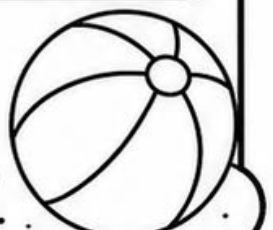
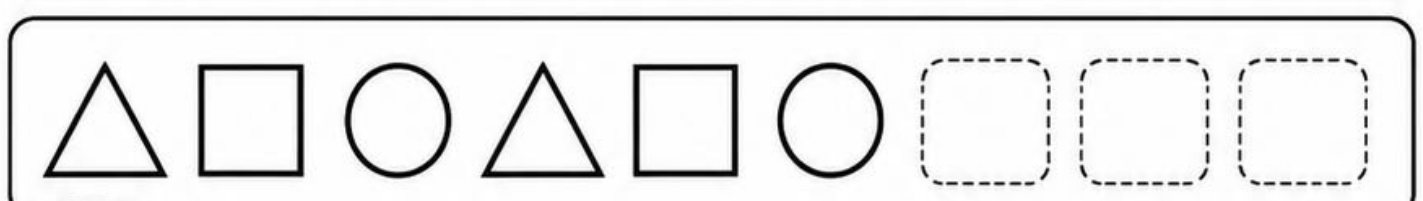
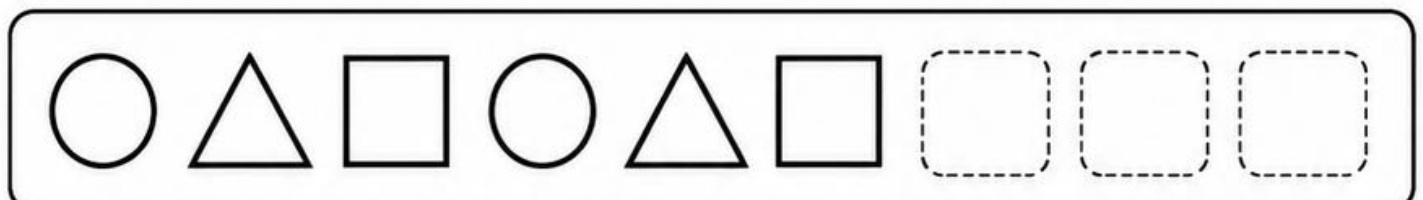
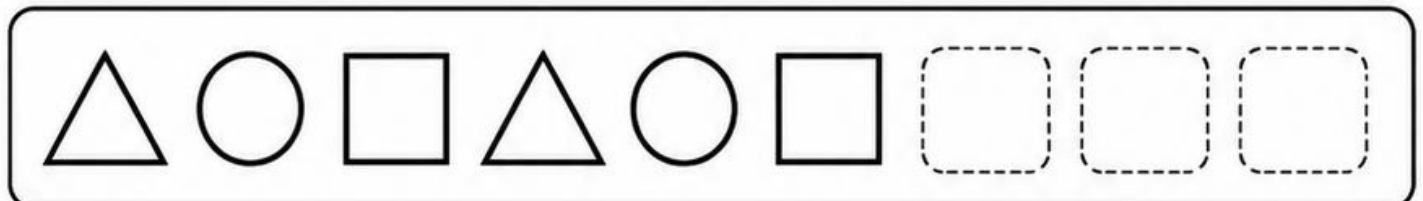
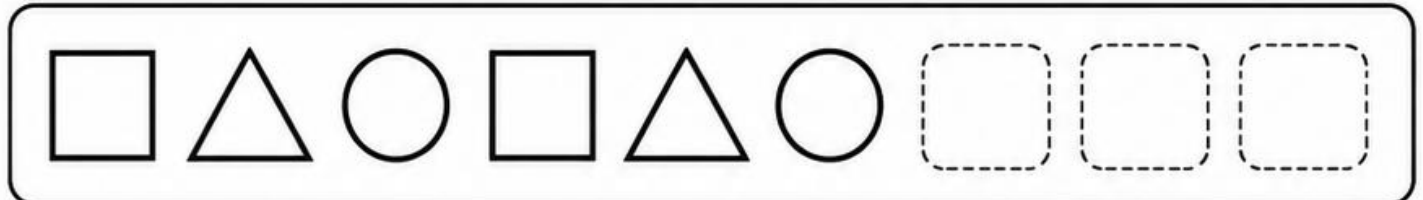
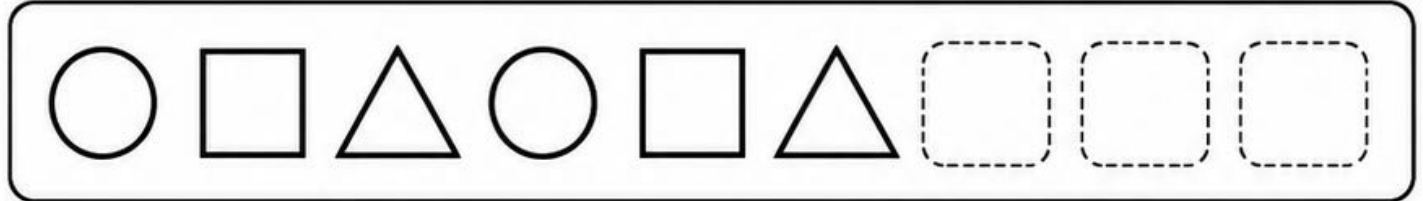

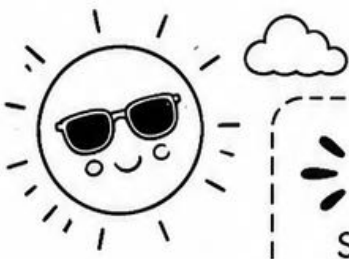



























COMPLETA LA SERIE









Sigue el patrón y completa los últimos 3 elementos.



















								
---	---	---	---	---	---	---	---	---





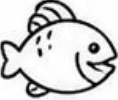

								
---	---	---	---	---	---	---	---	---

								
--	--	--	--	--	--	--	--	--

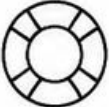
								
---	---	---	---	---	---	---	---	---

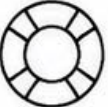
								
---	---	---	---	---	---	---	---	---

								
---	---	---	---	---	---	---	---	---

								
---	---	---	---	---	---	---	---	---





COMPLETA LA SERIE

Sigue el patrón y completa los últimos 3 elementos.

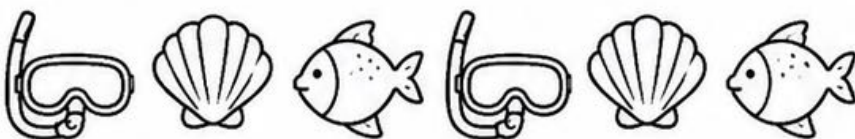
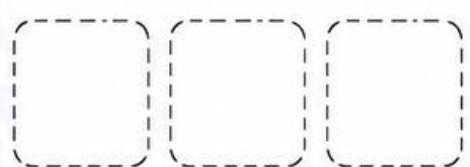
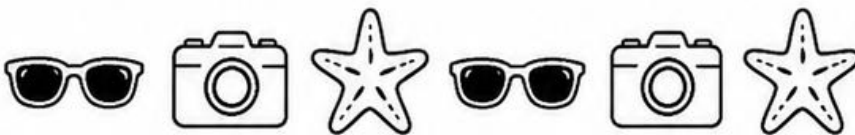
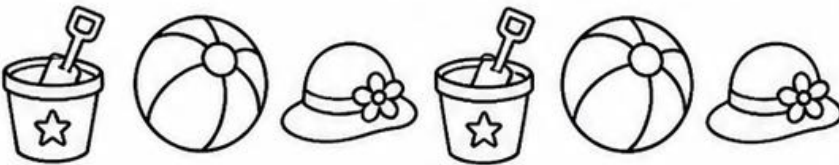

La letra m

1. Repasa la letra.

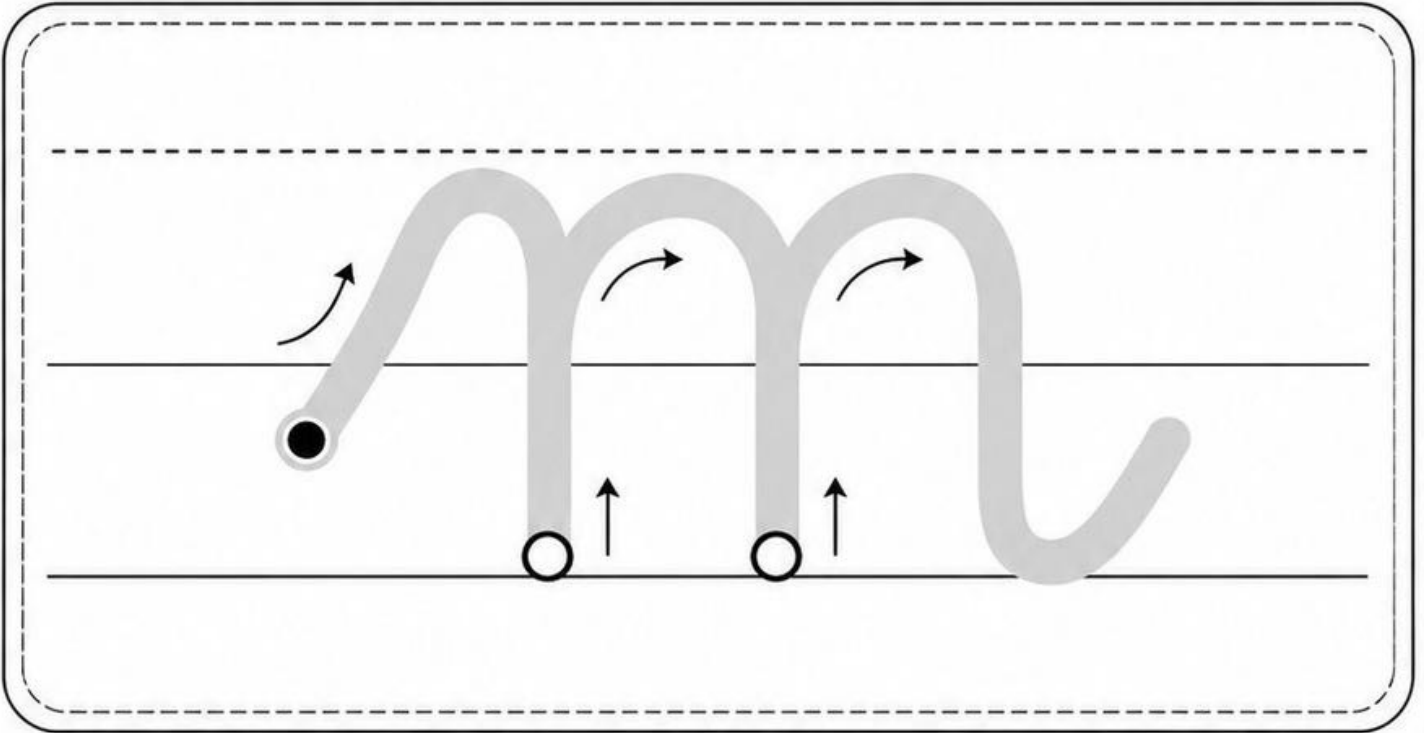

2. Rodea la m.

m M a m n M e l m o M u

3. Colorea los dibujos que empiezan por m.

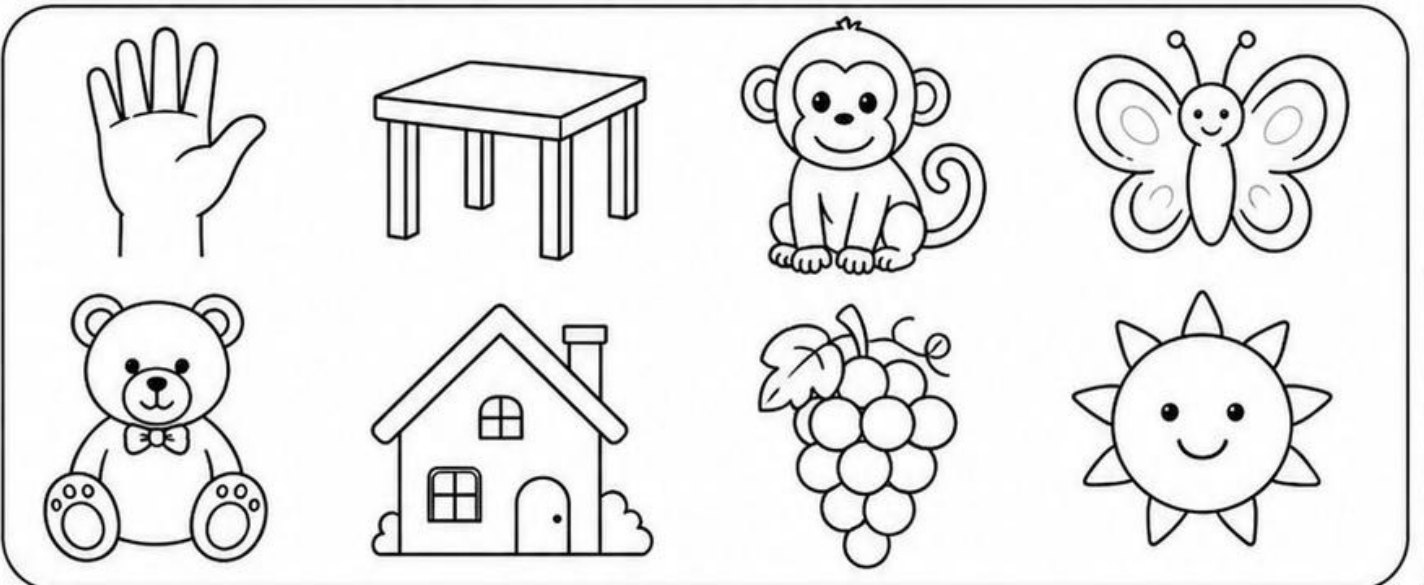

La letra p



1. Repasa la letra.

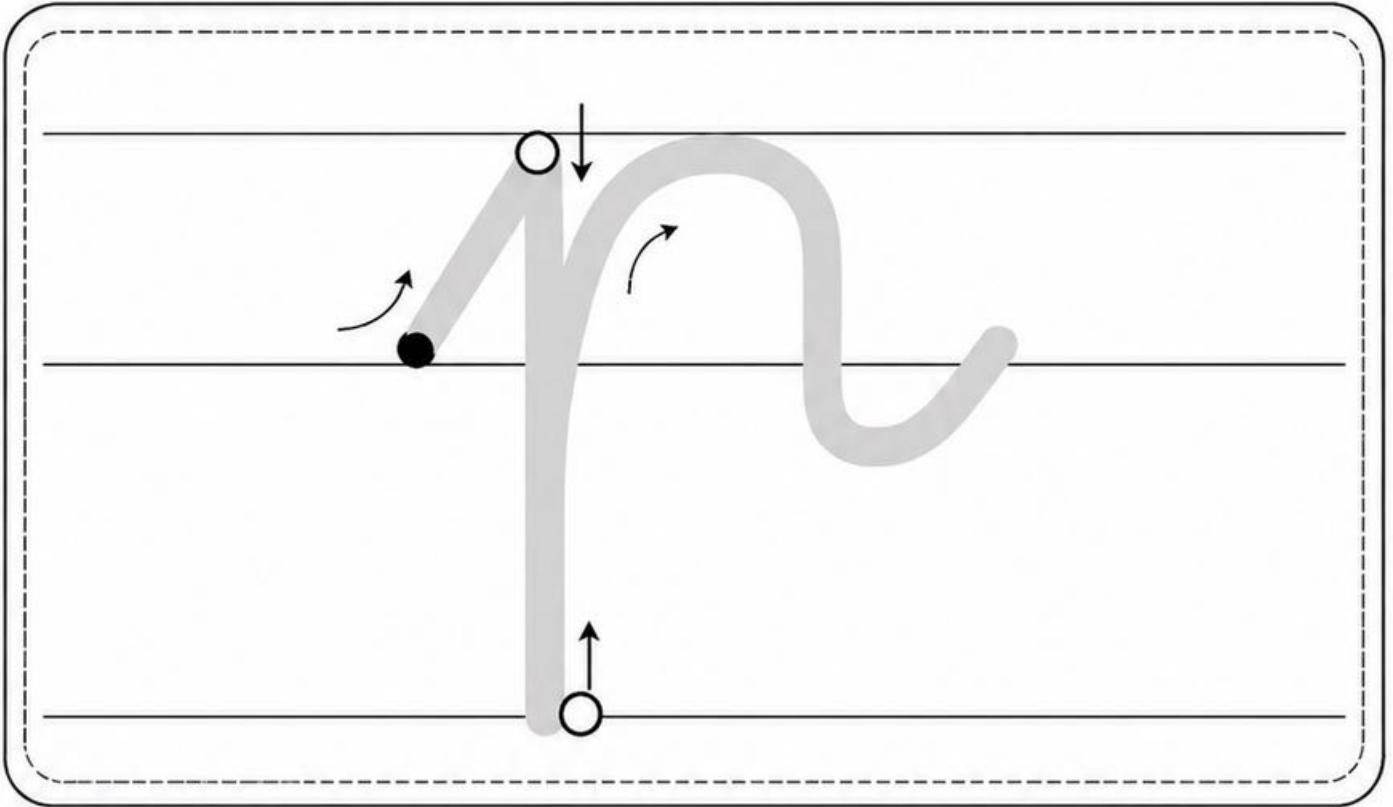

2. Rodea la p.



3. Colorea los dibujos que empiezan por p.

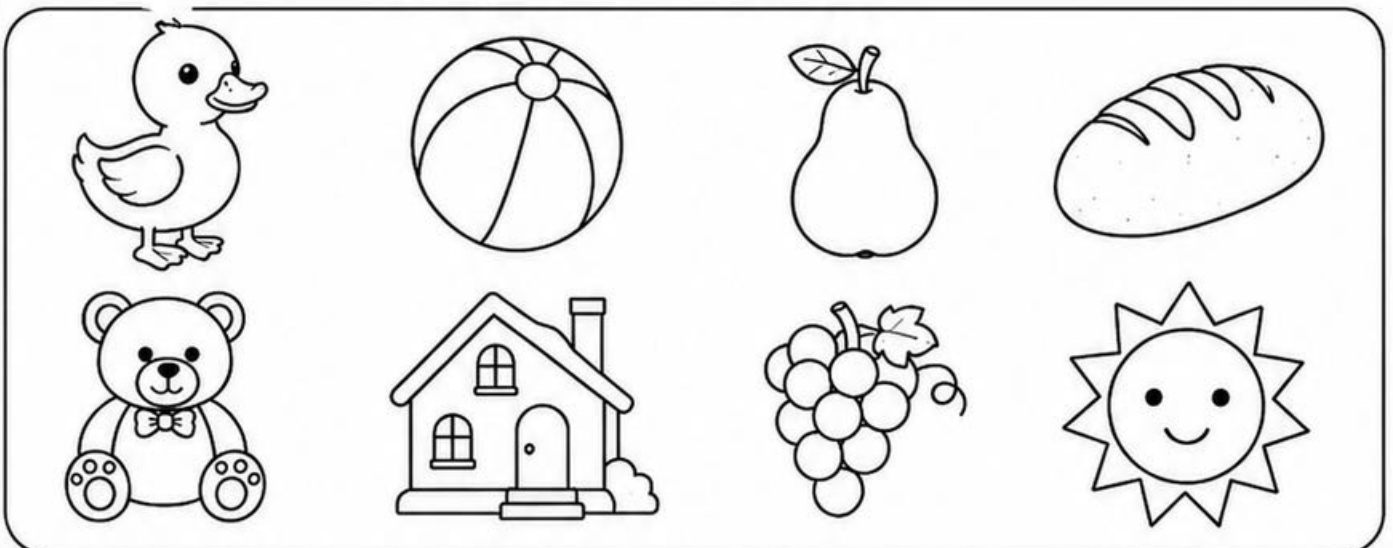

La letra l



1. Repasa la letra.

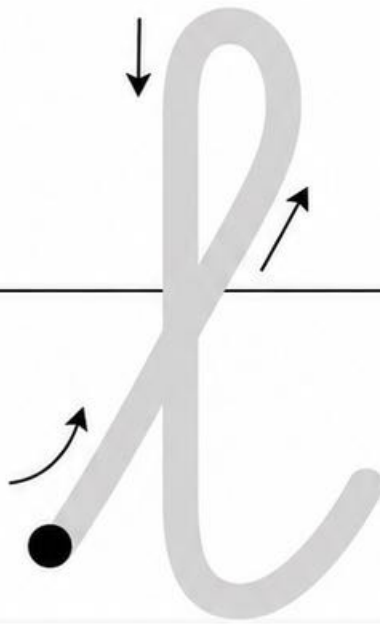

2. Rodea la l.

l L a l n L e i l o L u

3. Colorea los dibujos que empiezan por l.

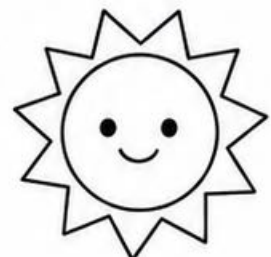
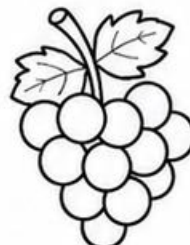
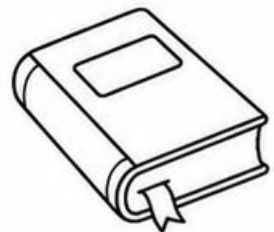

La letra s



1. Repasa la letra.

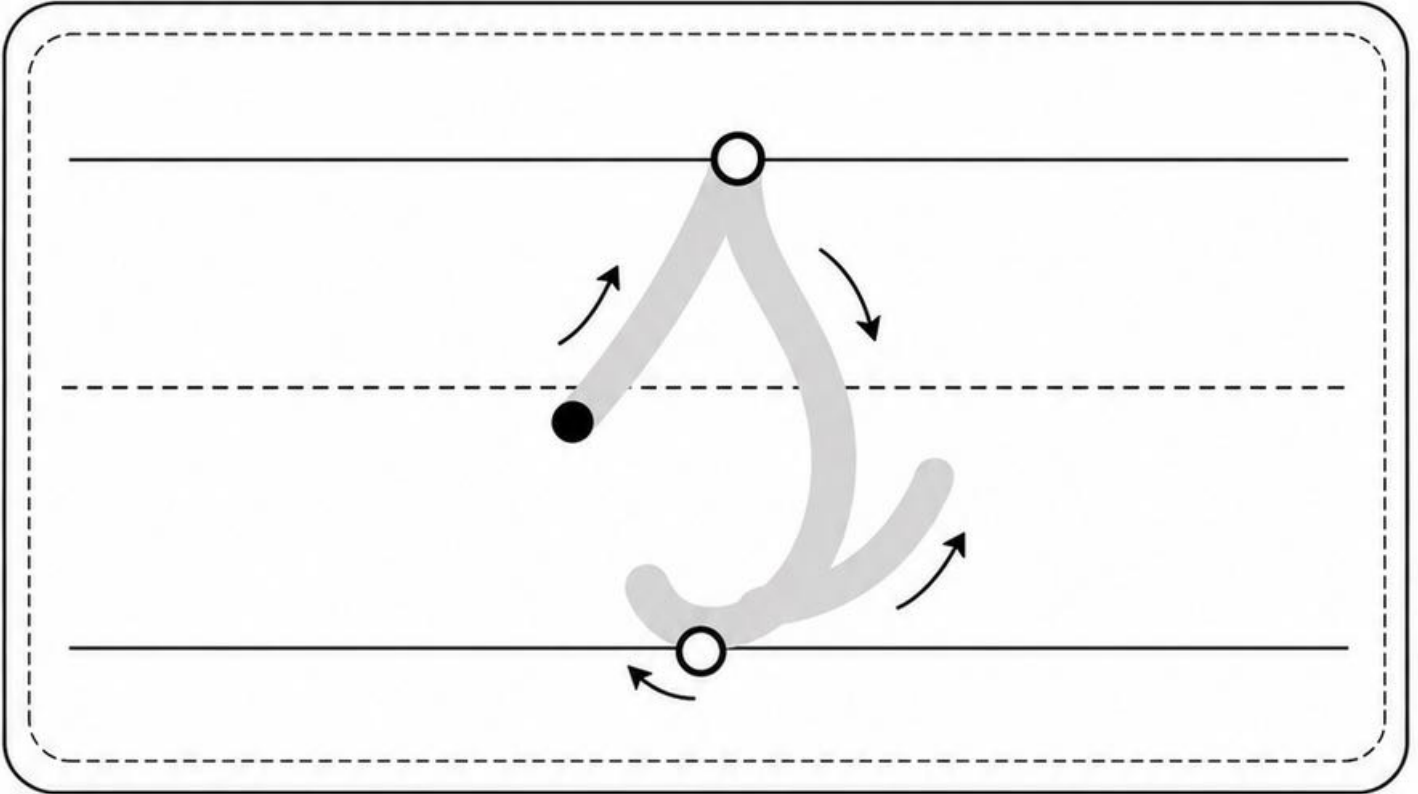

2. Rodea la s.



3. Colorea los dibujos que empiezan por s.

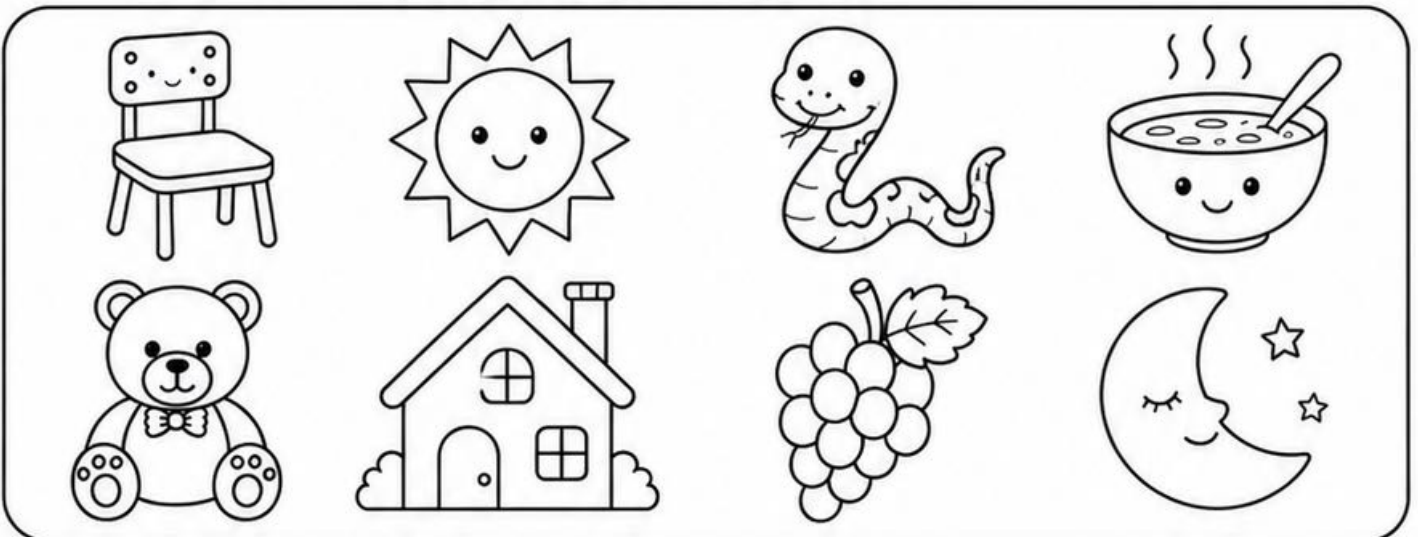

La letra t



1. Repasa la letra.

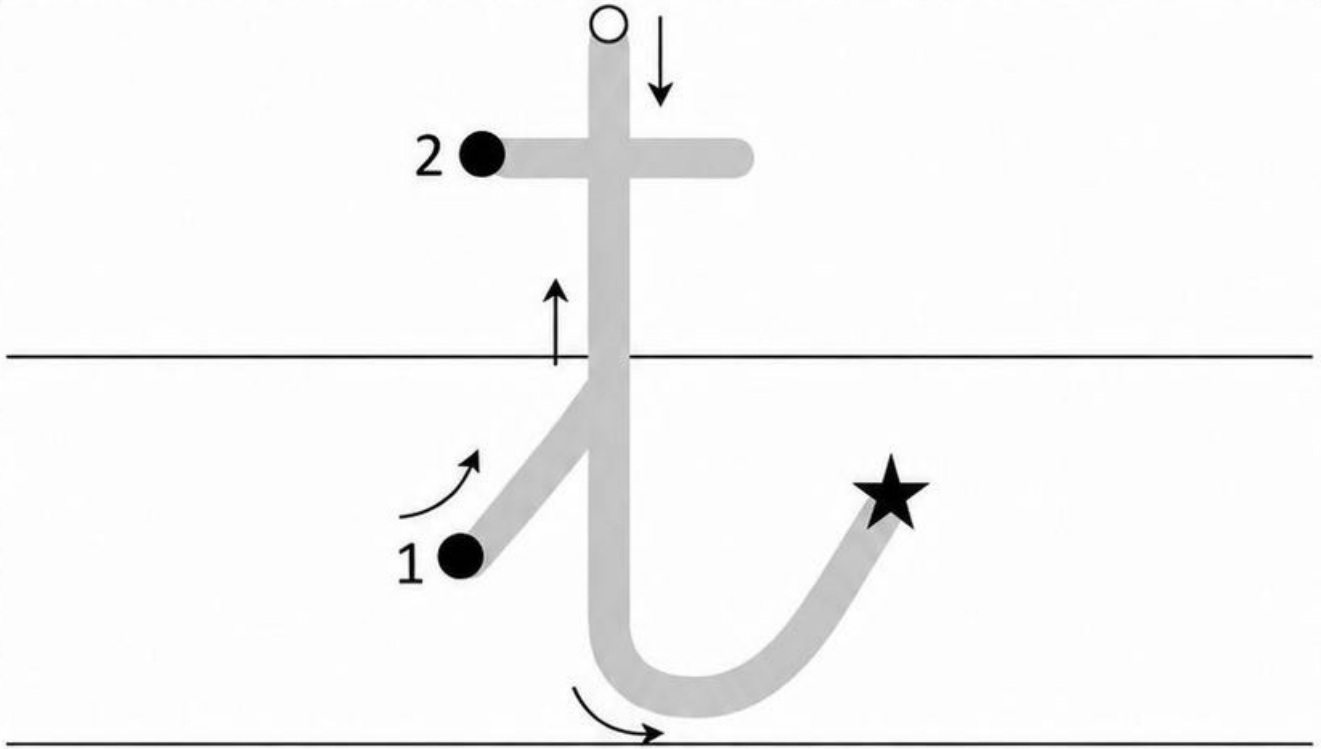

2. Rodea la t.

t l f t T t j t f t L t

3. Colorea los dibujos que empiezan por t.

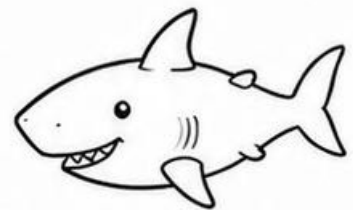
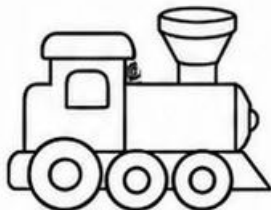
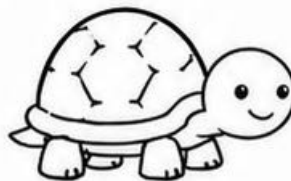
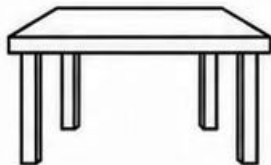

La letra n



1. Repasa la letra.

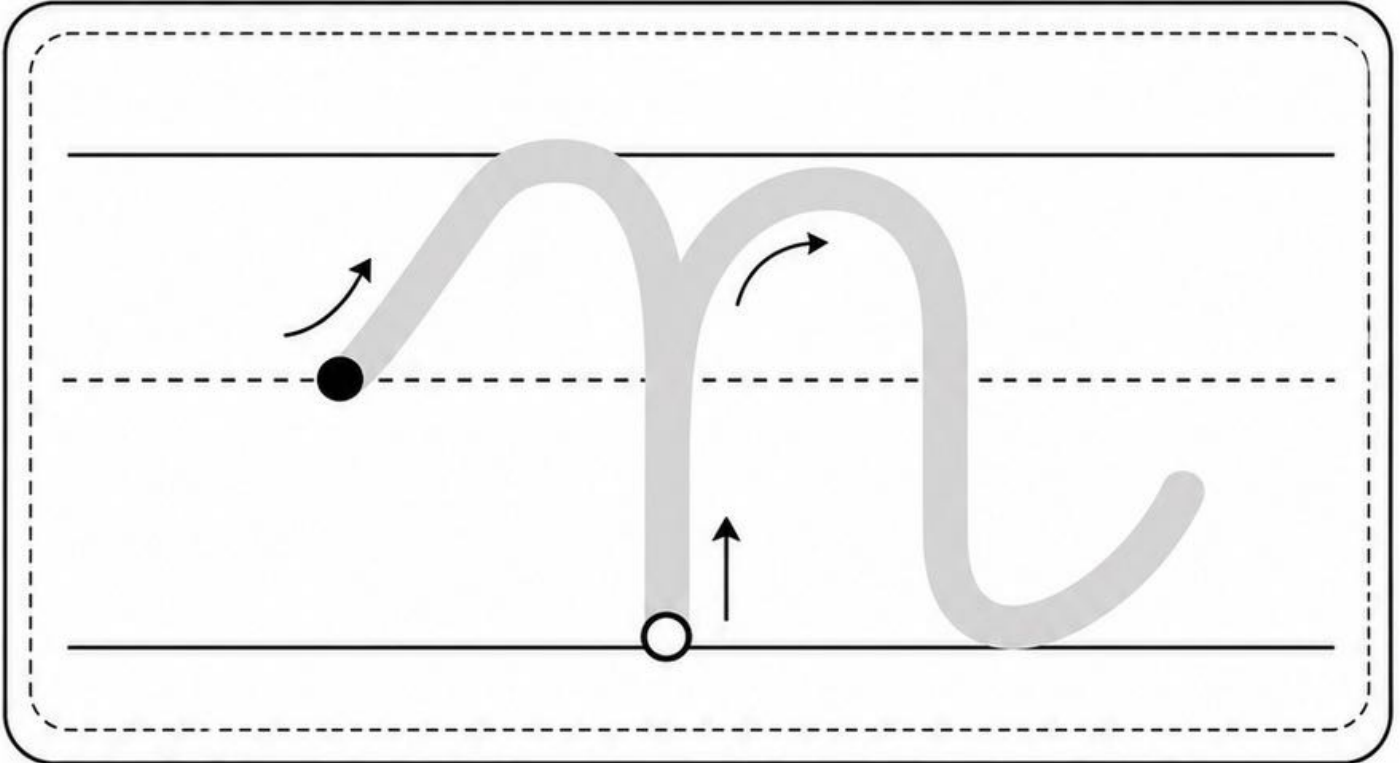

2. Rodea la n.



3. Colorea los dibujos que empiezan por n.

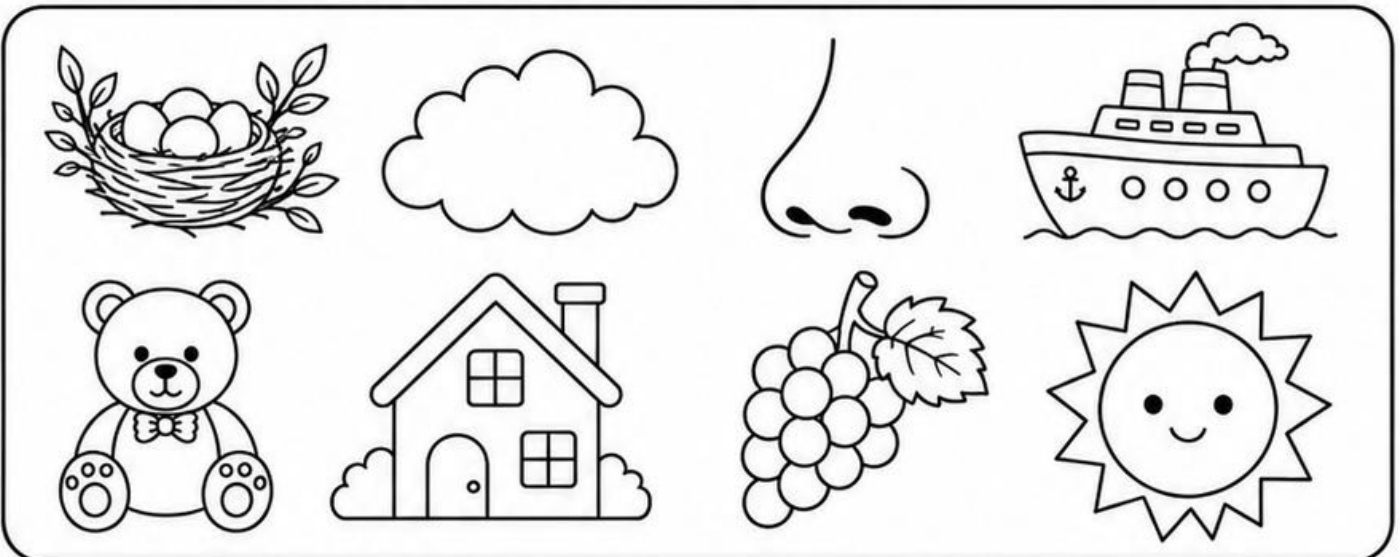

La letra d



1. Repasa la letra.

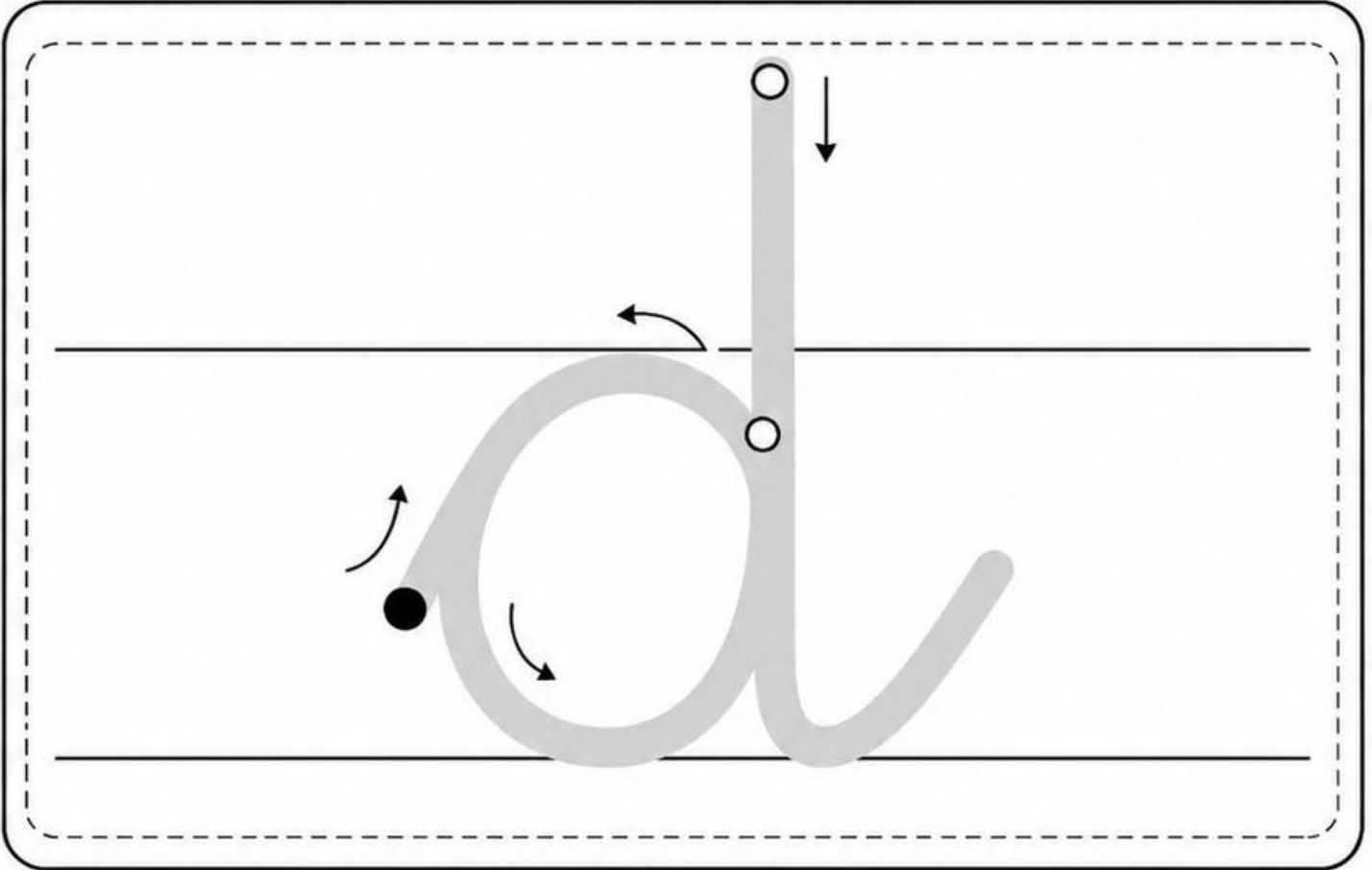

2. Rodea la d.

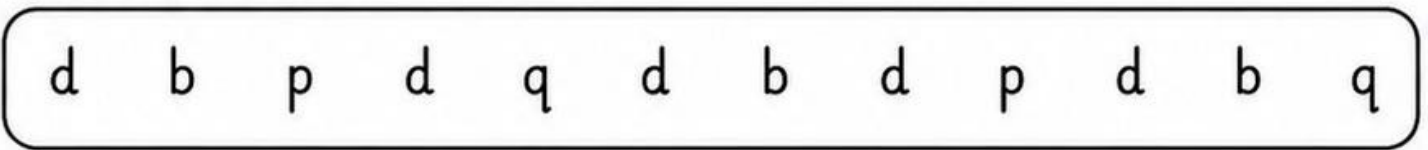

3. Colorea los dibujos que empiezan por d.

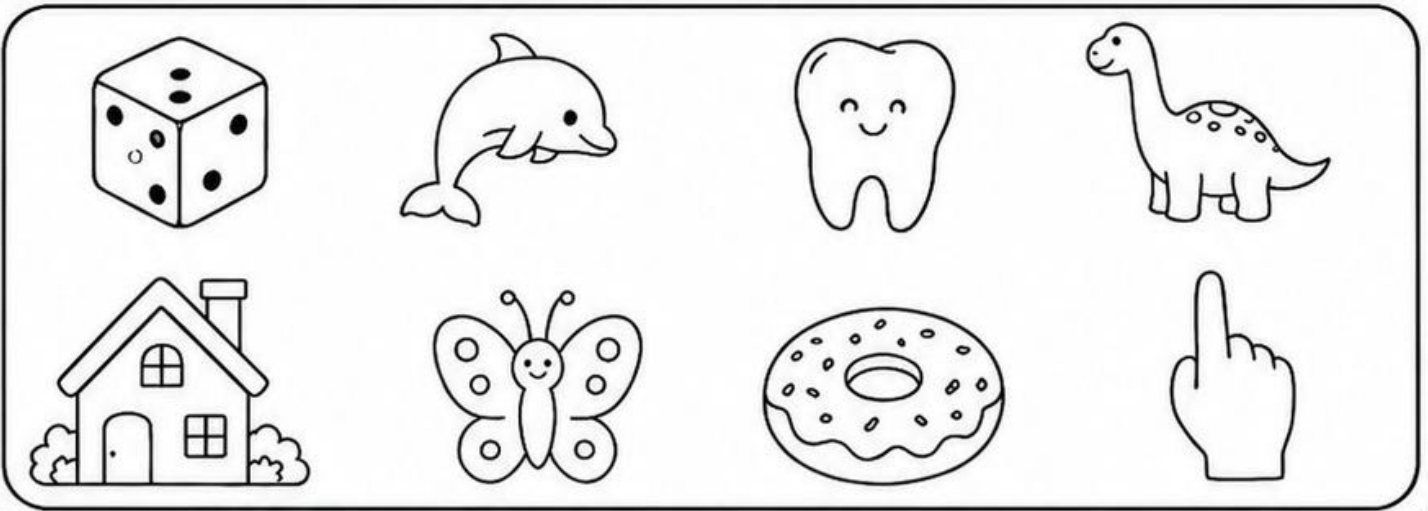

La letra f



1. Repasa la letra.

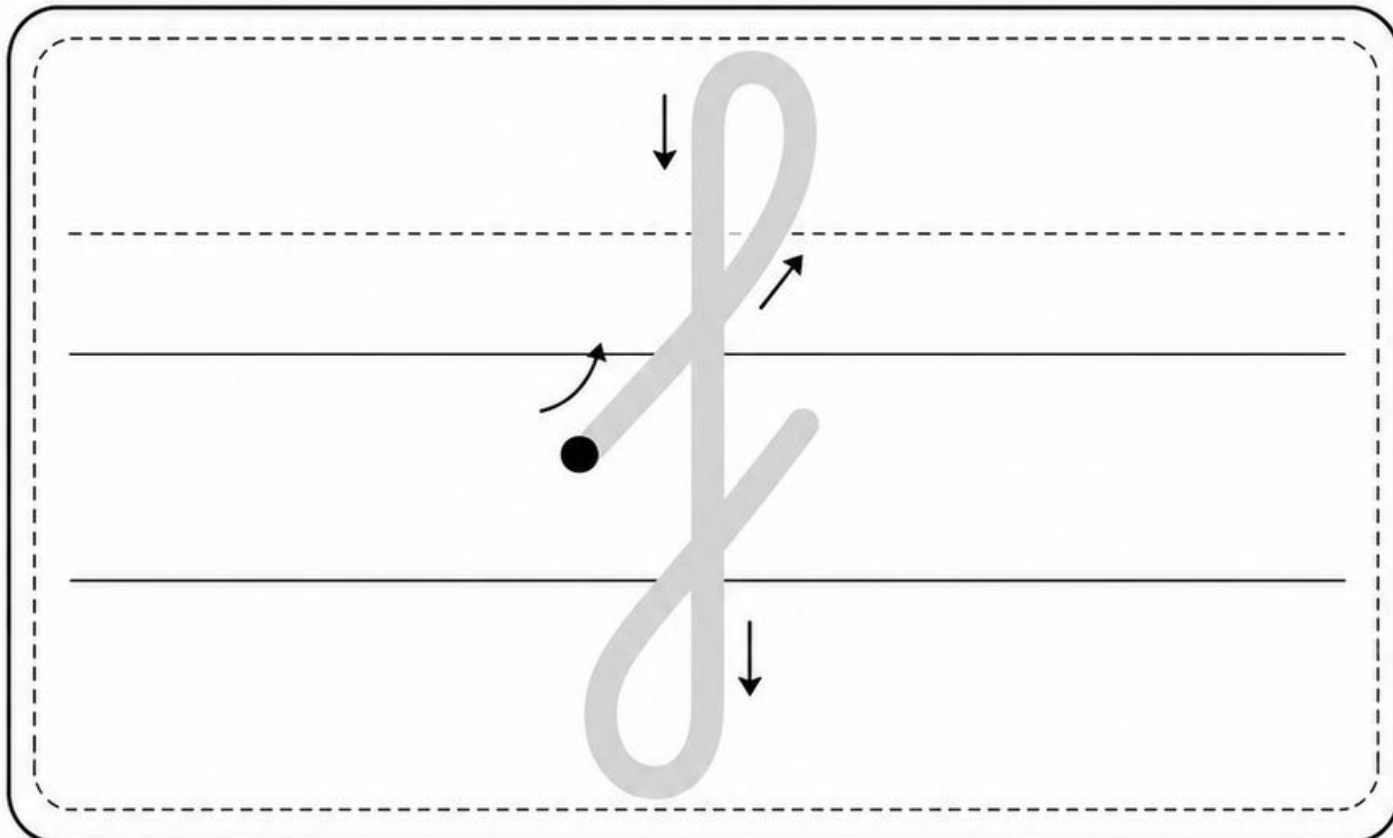

2. Rodea la f.



3. Colorea los dibujos que empiezan por f.

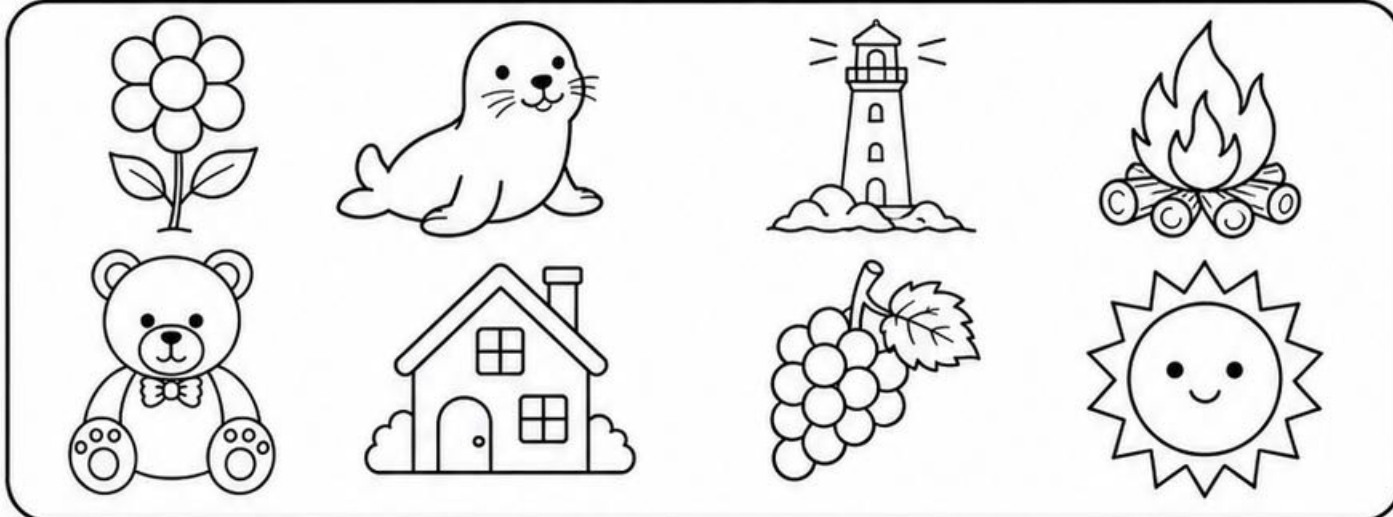

La letra r



1. Repasa la letra.

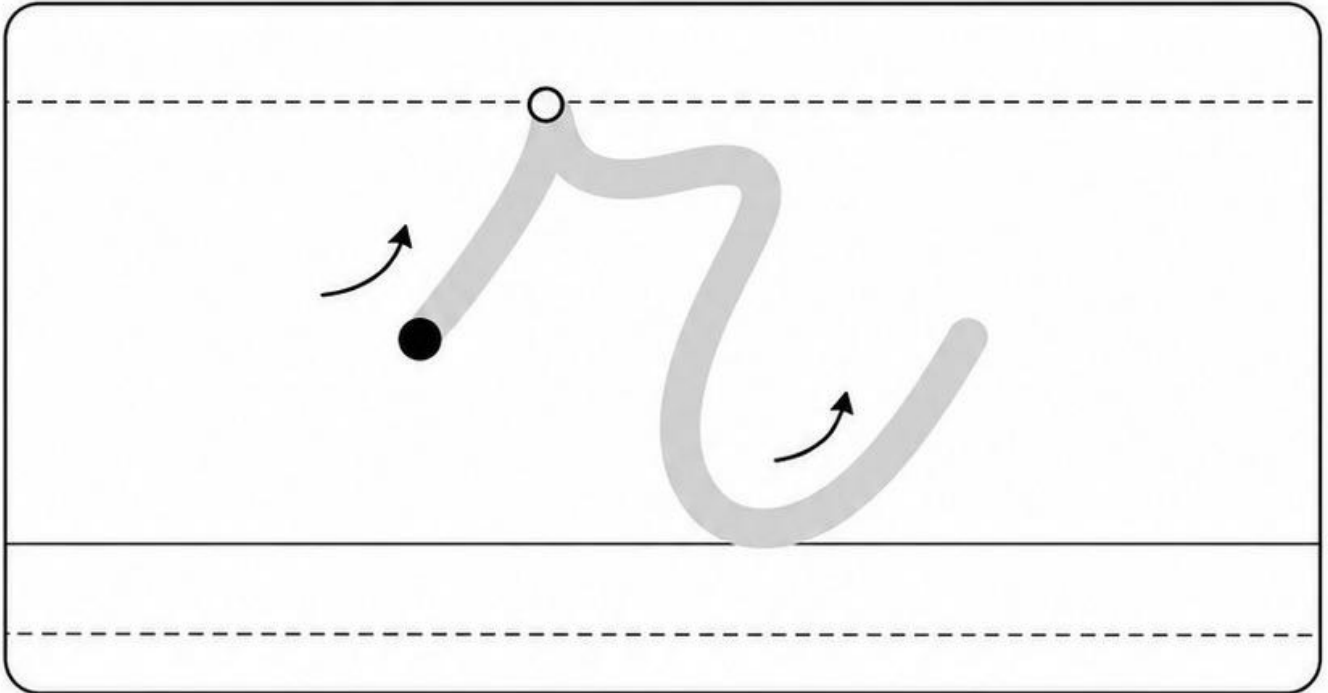

2. Rodea la r.

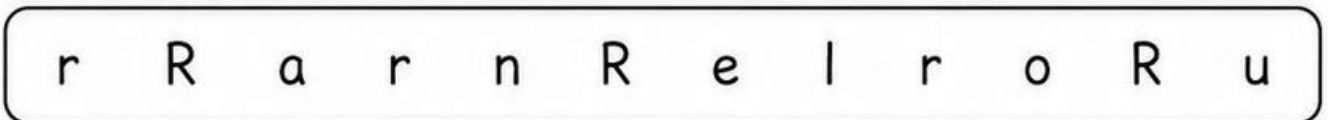

3. Colorea los dibujos que empiezan por r.

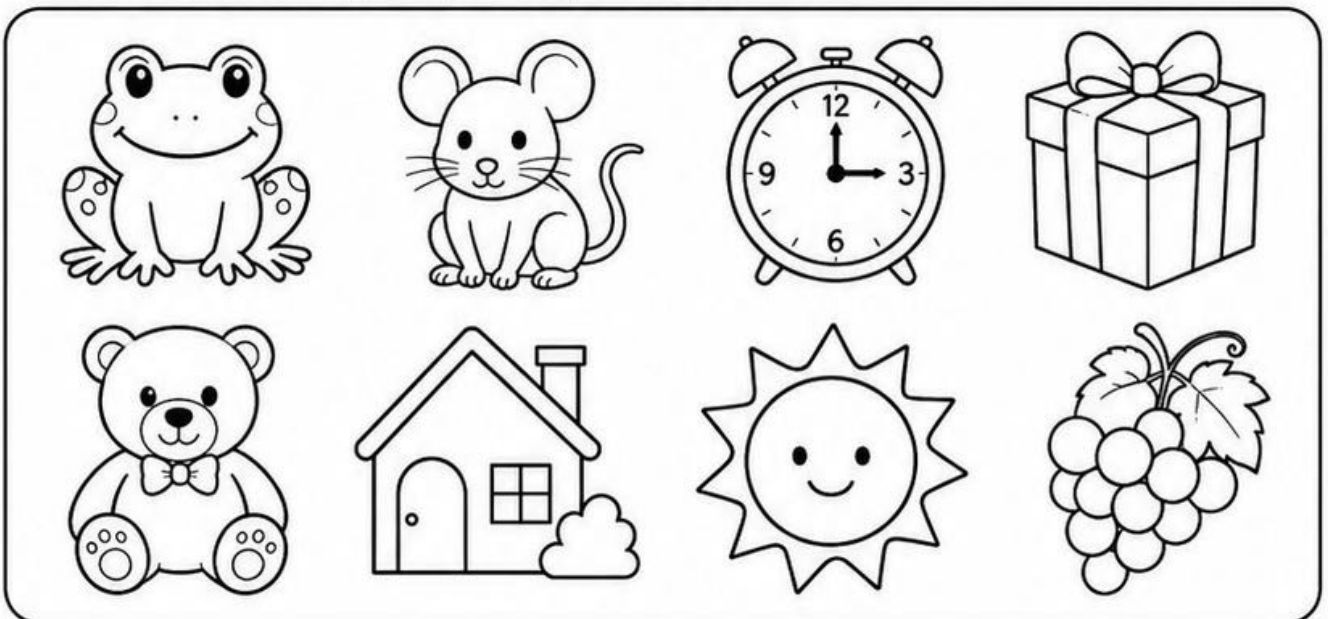

La letra b.



1. Repasa la letra.

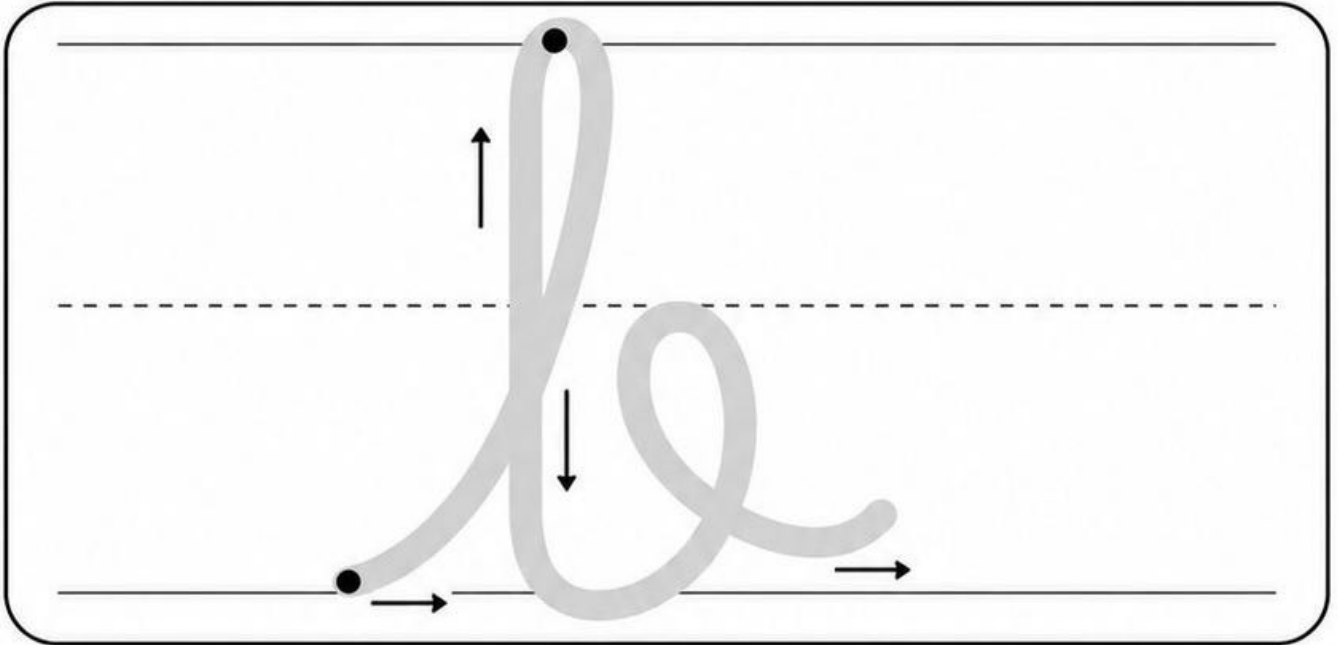

2. Rodea la b.

b B a b d B e l b o B u

3. Colorea los dibujos que empiezan por b.

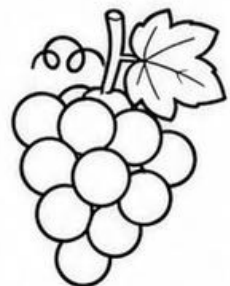
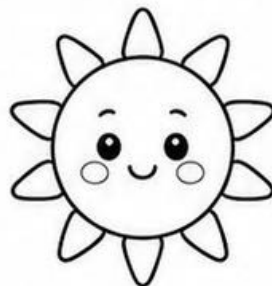

La letra v



1. Repasa la letra.

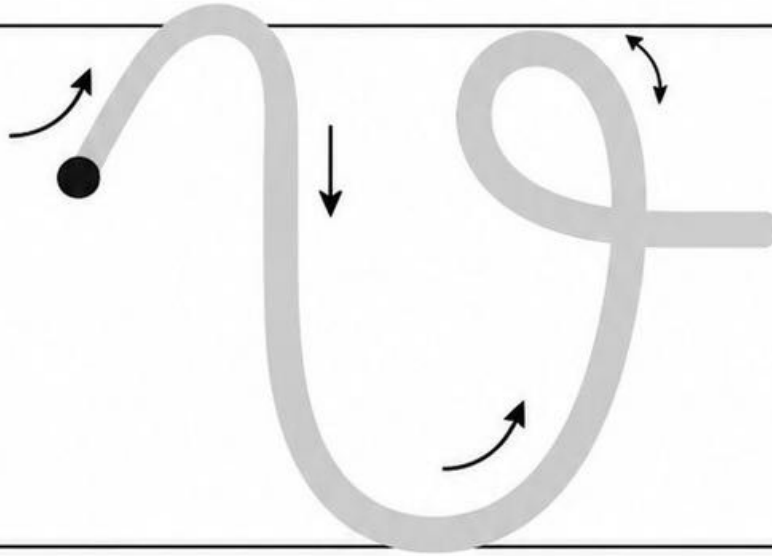

2. Rodea la v.

va ve vi vo vu av ev iv ov uv vi vu

3. Colorea los dibujos que empiezan por v.

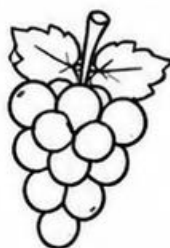
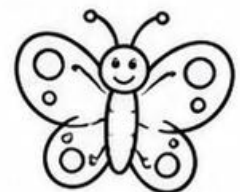
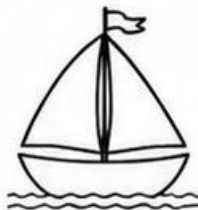
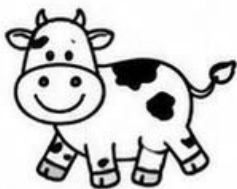
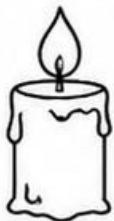

La letra g



1. Repasa la letra.

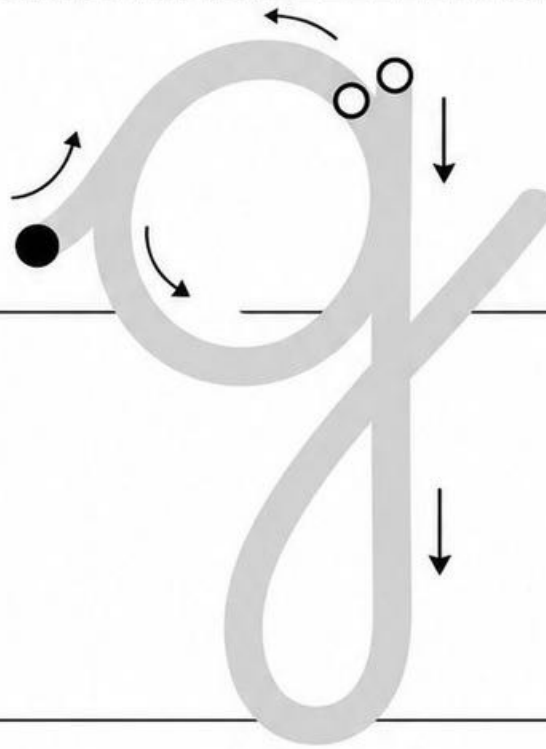

2. Rodea la g.

g G a g q G e l g o G u

3. Colorea los dibujos que empiezan por g.

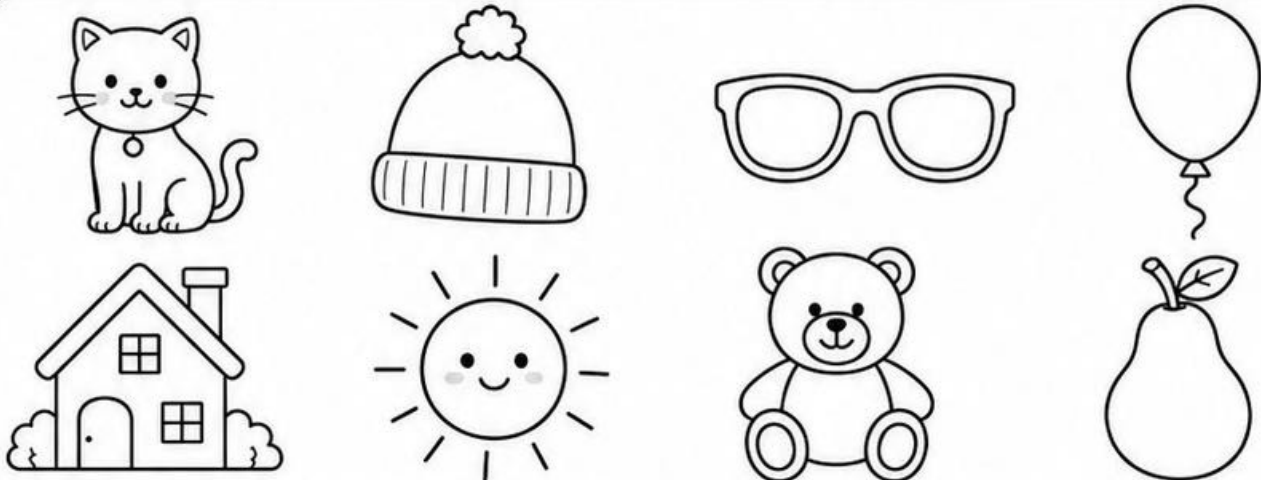

La letra j



1. Repasa la letra.

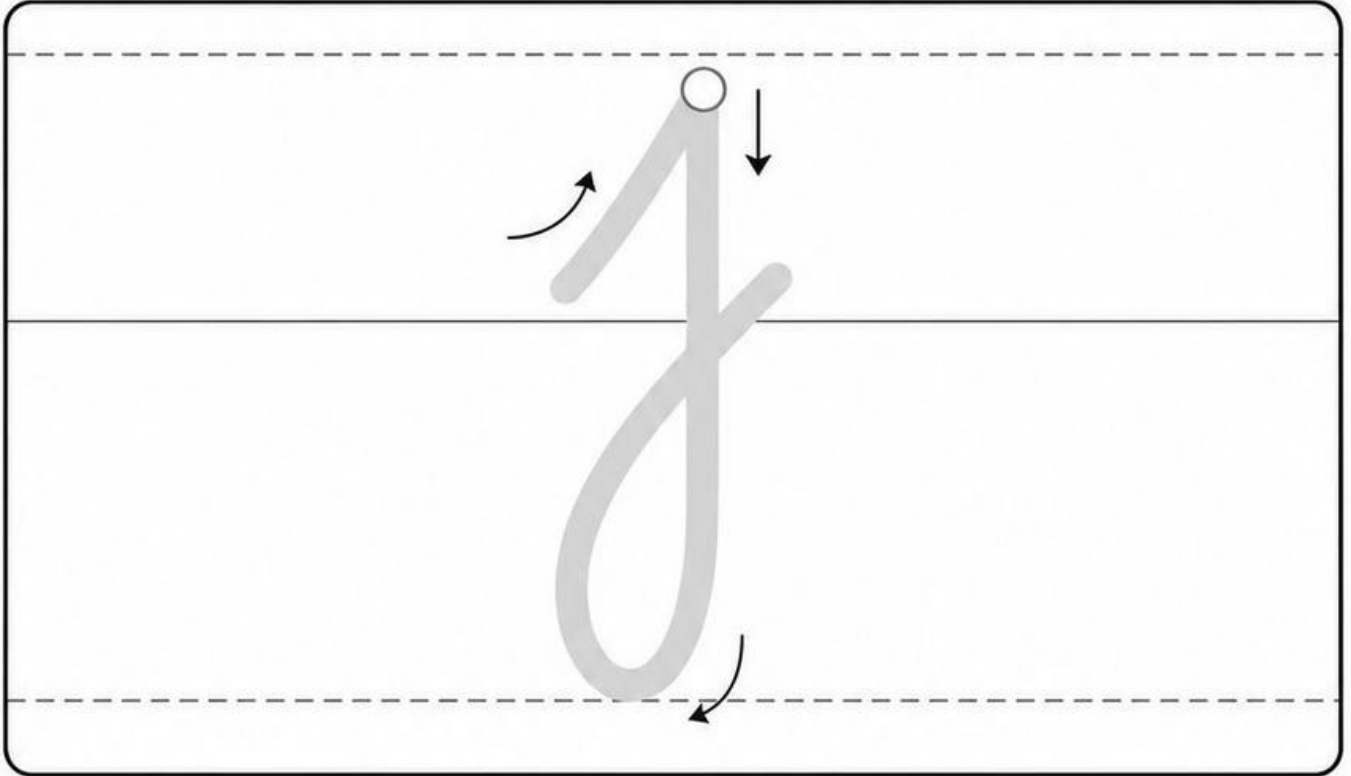

2. Rodea la j.

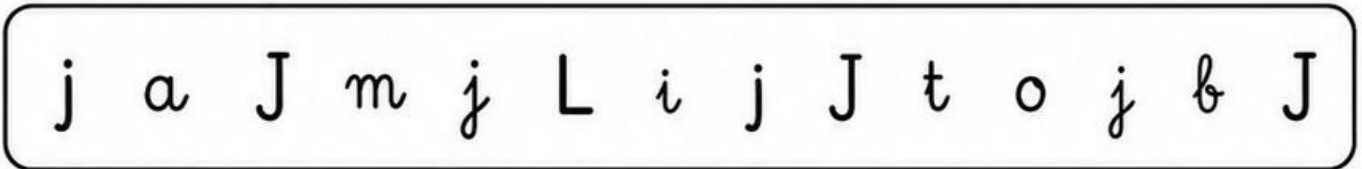

3. Colorea los dibujos que empiezan por j.

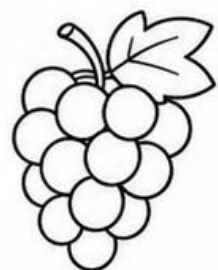
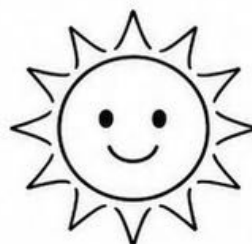

La letra c



1. Repasa la letra.

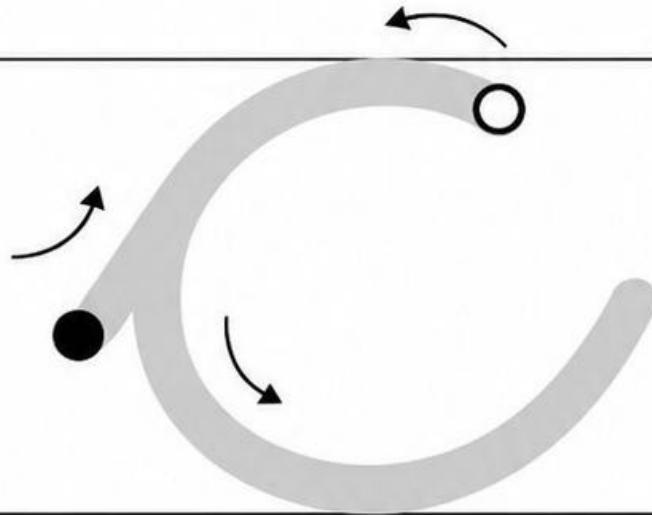

2. Rodea la c.

c e C o a c e C u c o a C c

3. Colorea los dibujos que empiezan por c.

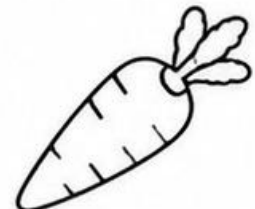
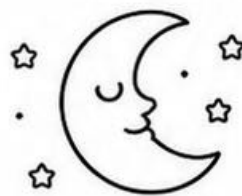

La letra qu



1. Repasa la letra.

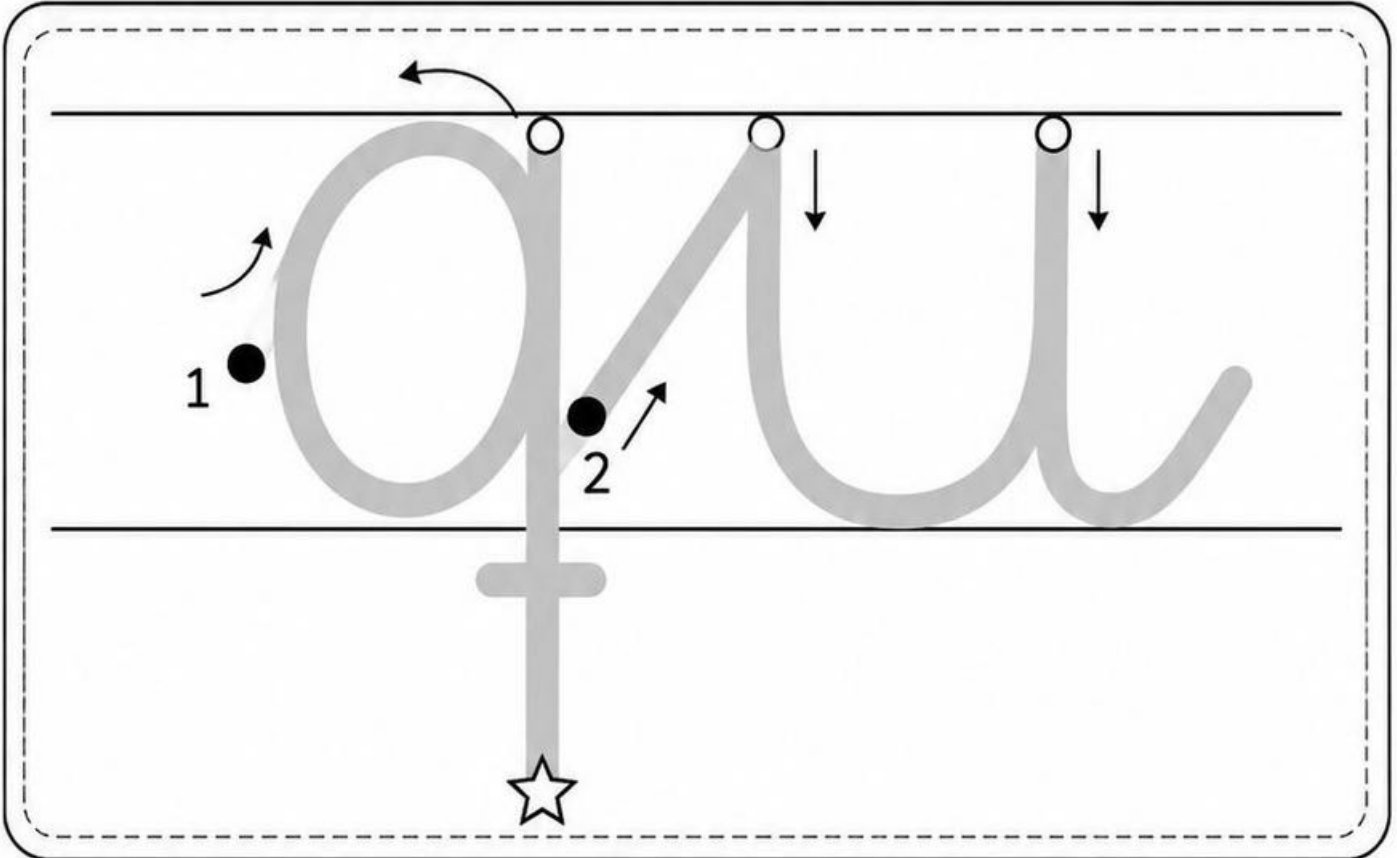

2. Rodea la qu.

qa que qi qo qu qa qu qi qu qo que qu

3. Colorea los dibujos que empiezan por qu.

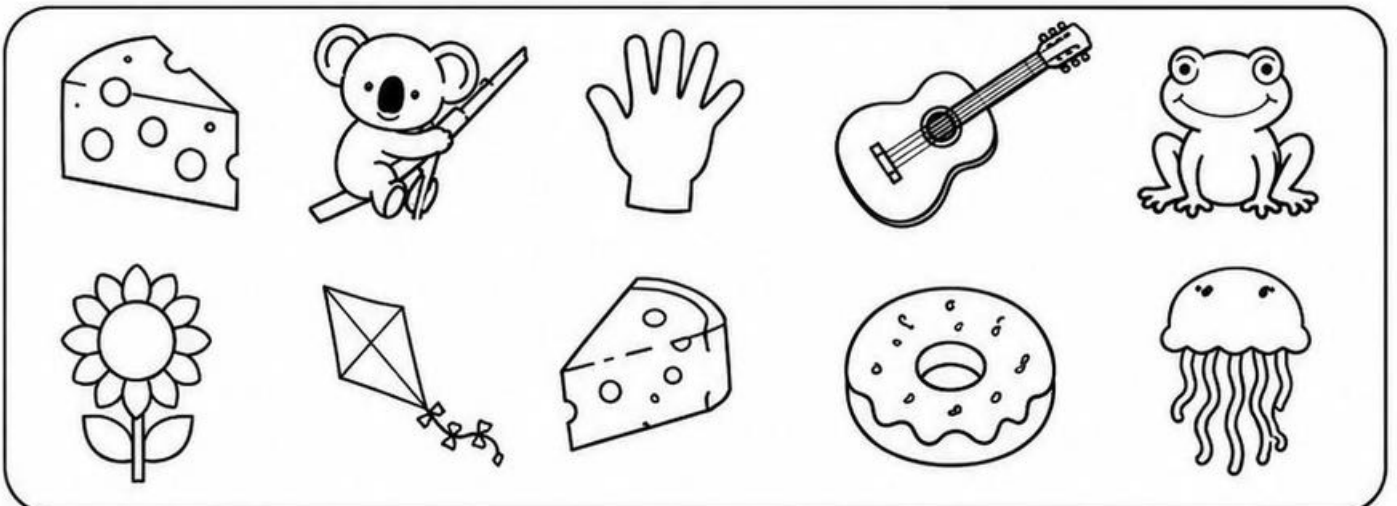

La letra z



1. Repasa la letra.

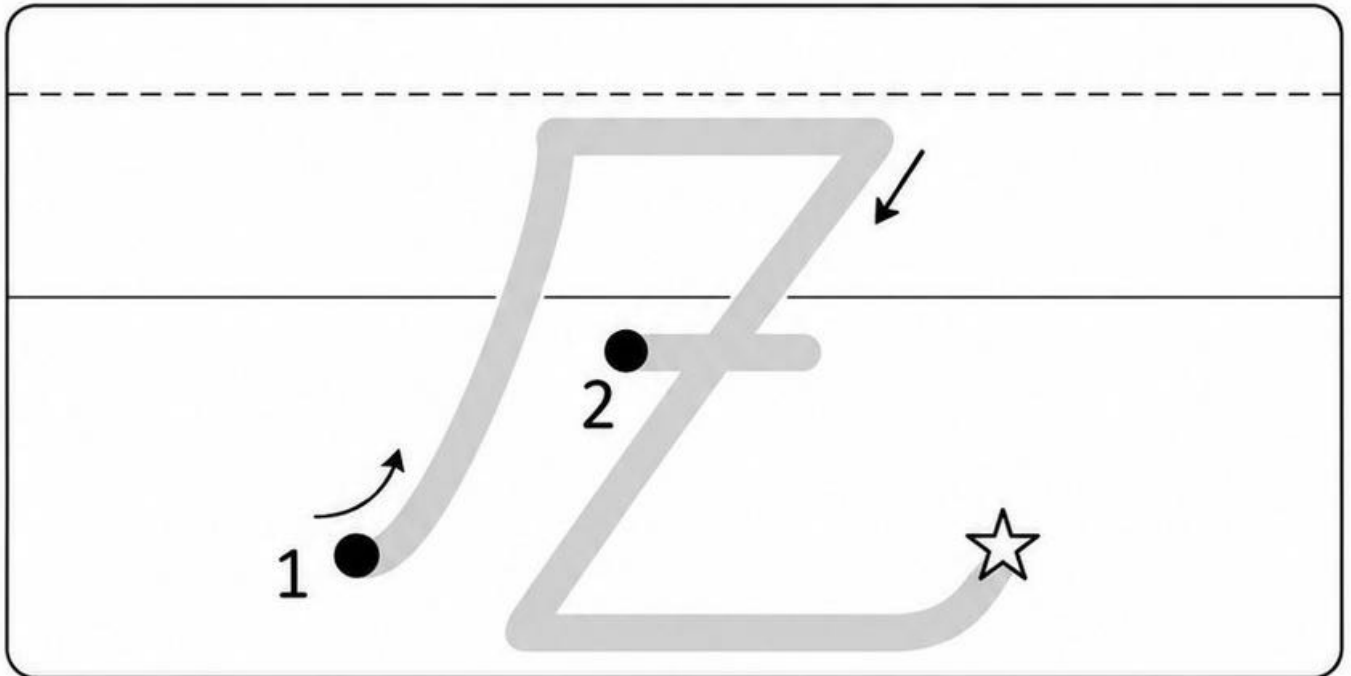

2. Rodea la z.

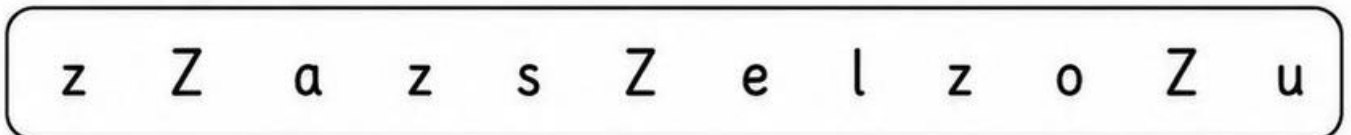

3. Colorea los dibujos que empiezan por z.



zapato



zorro

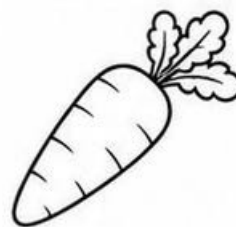

zanahoria



zumo



casa



oso

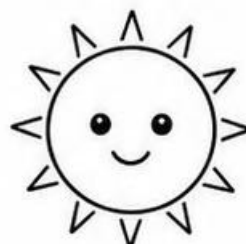

sol



uvas



La letra ll



1. Repasa la letra.

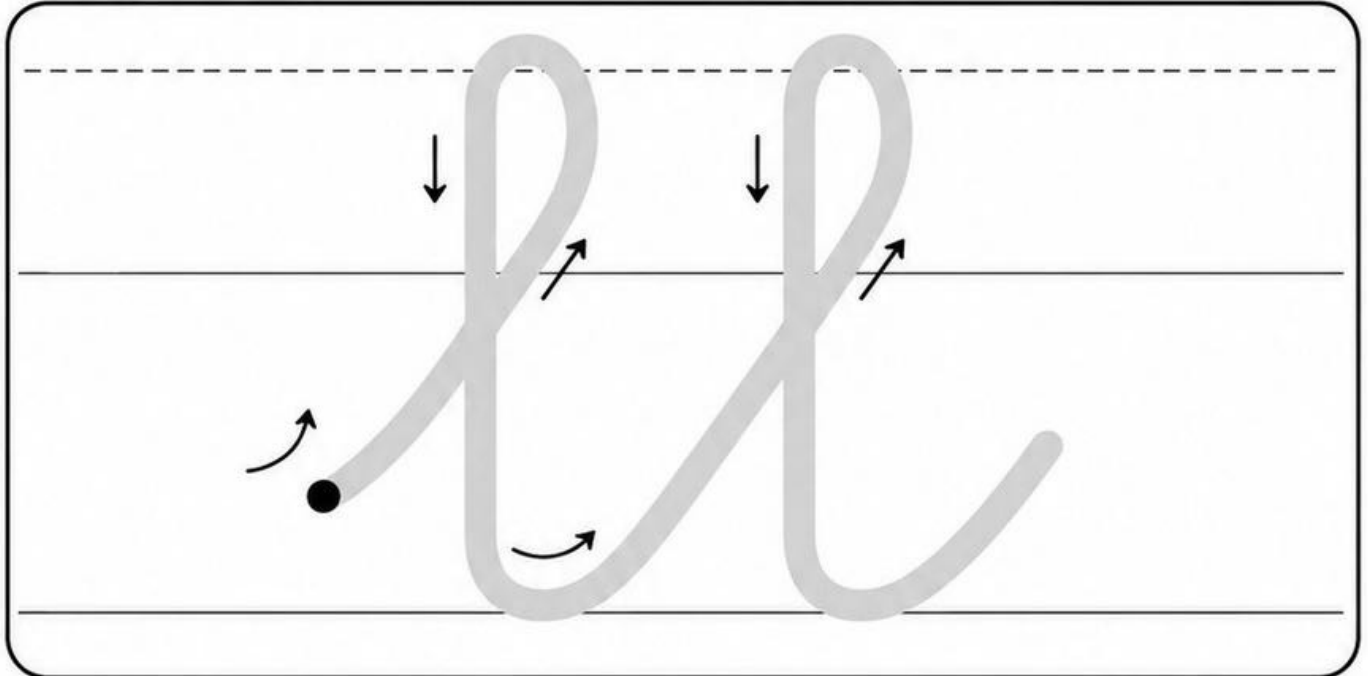

2. Rodea la ll.

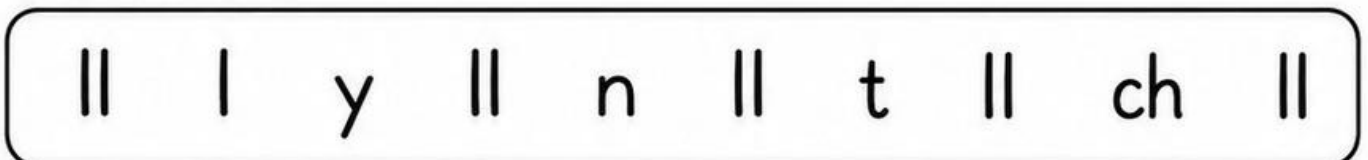

3. Colorea los dibujos que empiezan por ll.

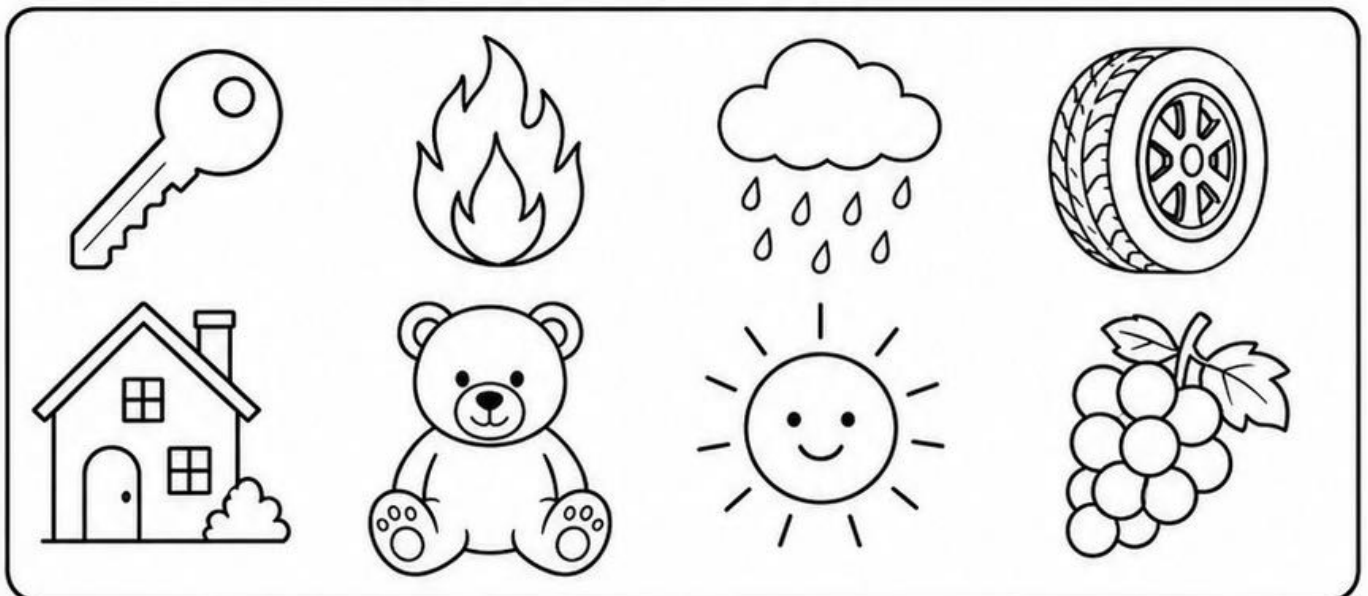

La letra h



1. Repasa la letra.

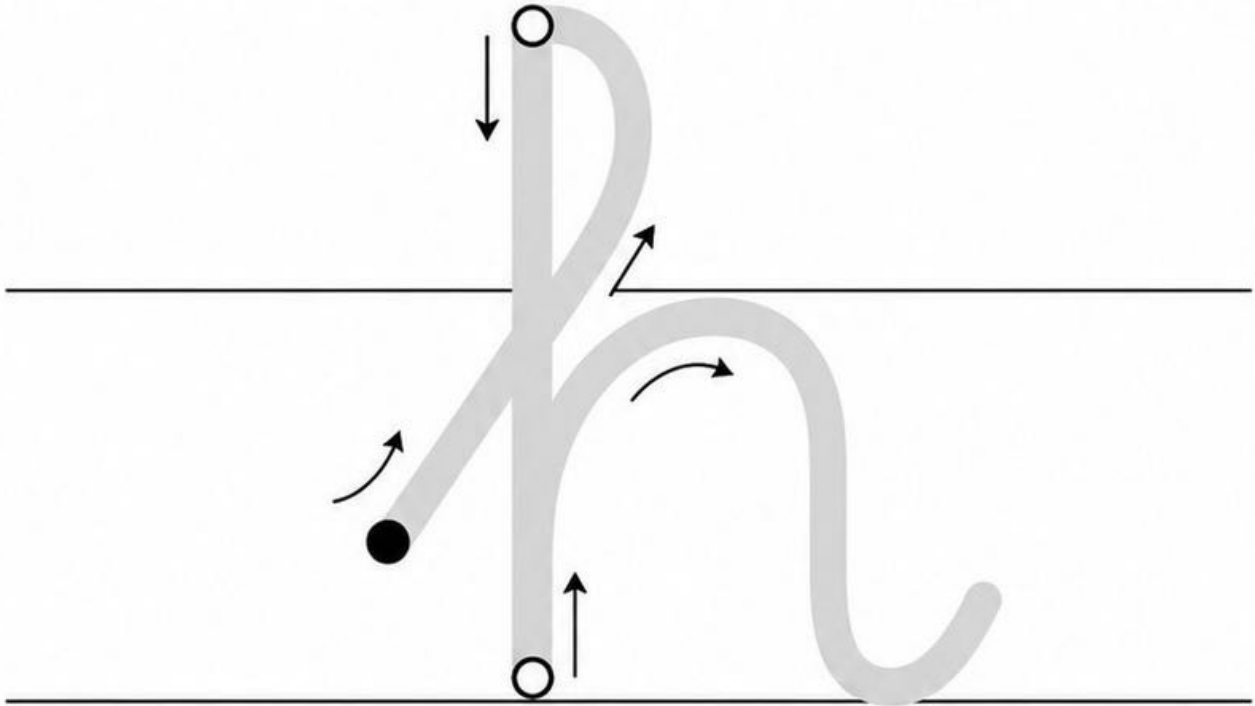

2. Rodea la h.

h n b h k h n h m h k

3. Colorea los dibujos que empiezan por h.

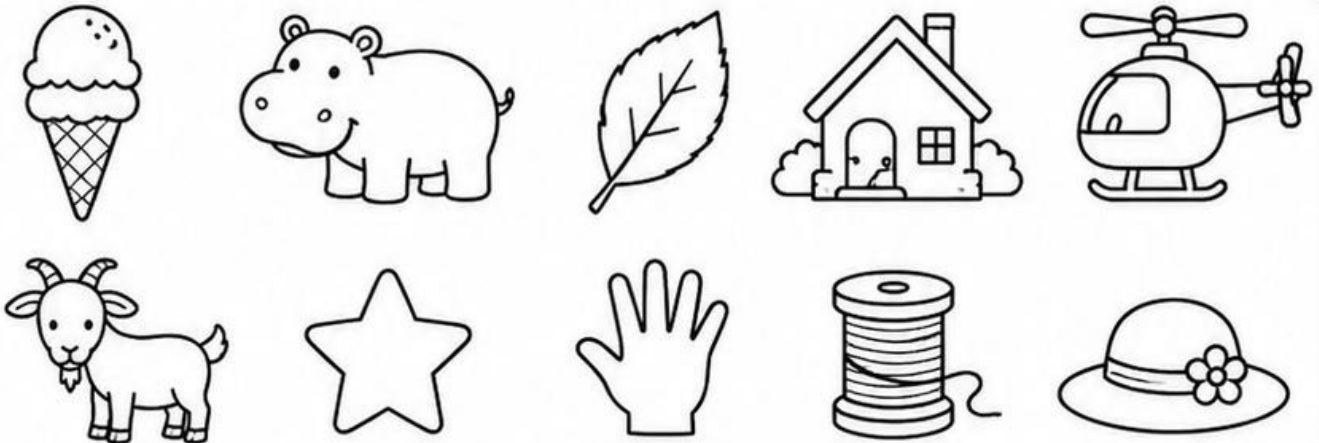

La letra ch



1. Repasa la letra.

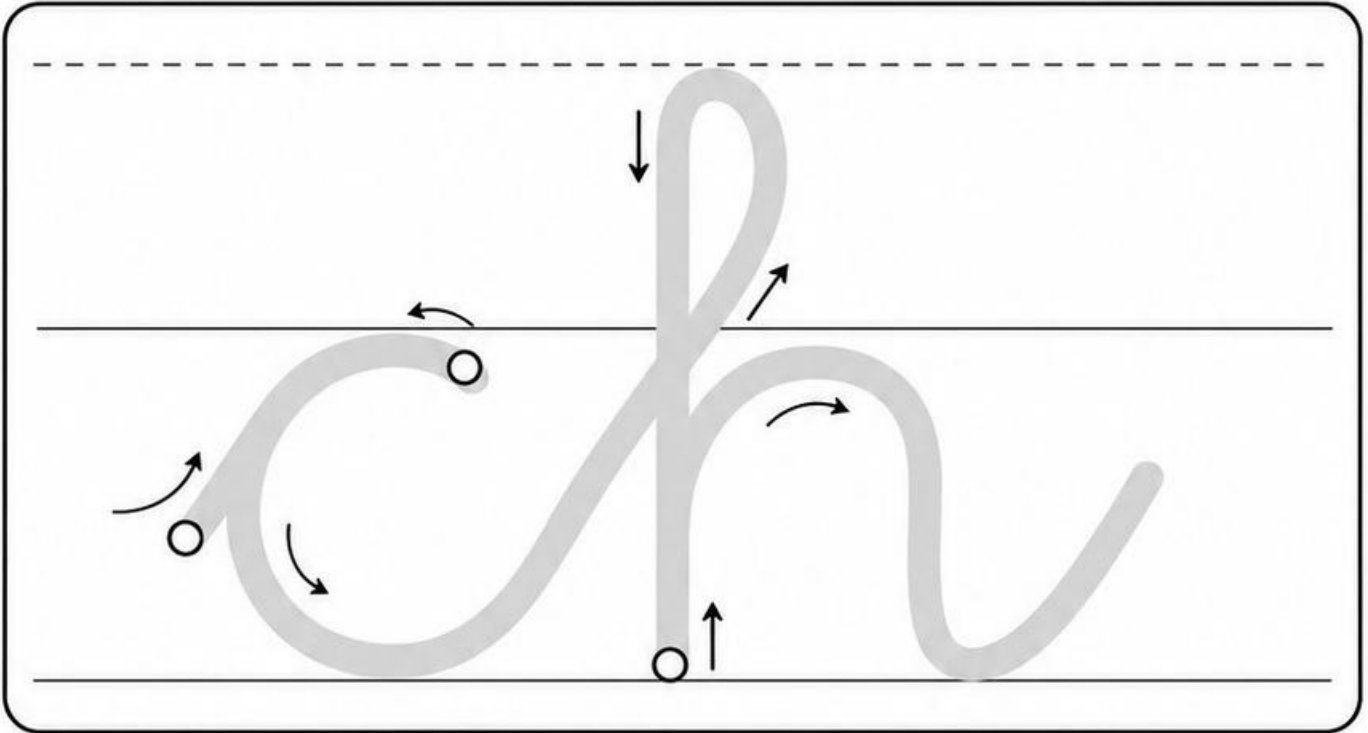

2. Rodea la ch.

ch c h ch l ch t ch n ch m ch

3. Colorea los dibujos que empiezan por ch.

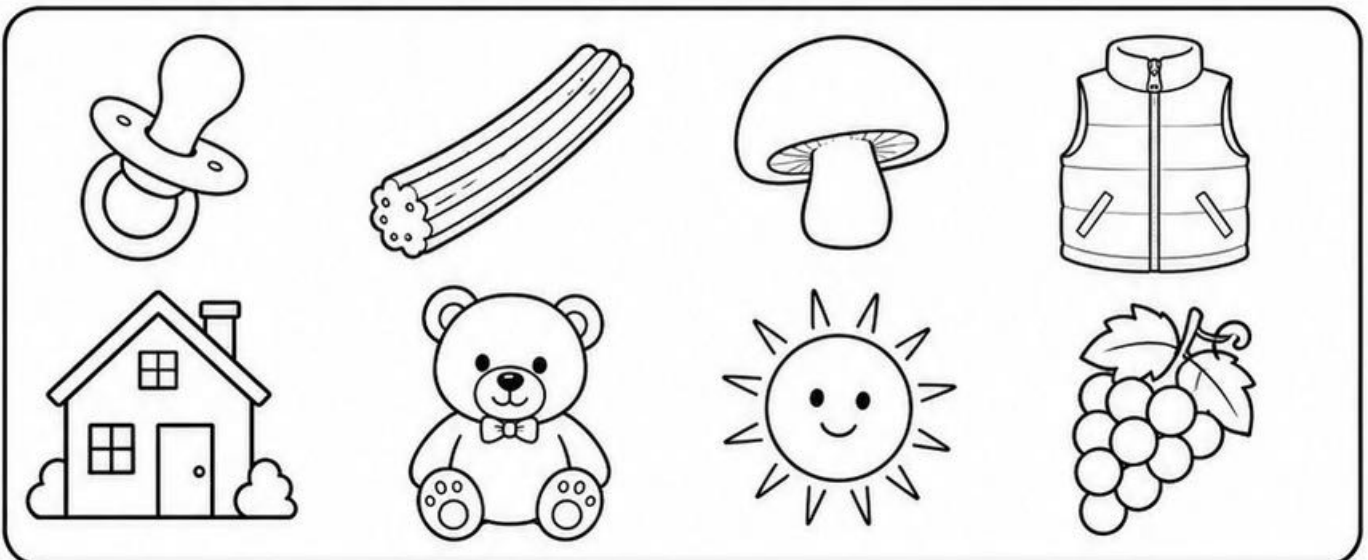

La letra k



1. Repasa la letra.

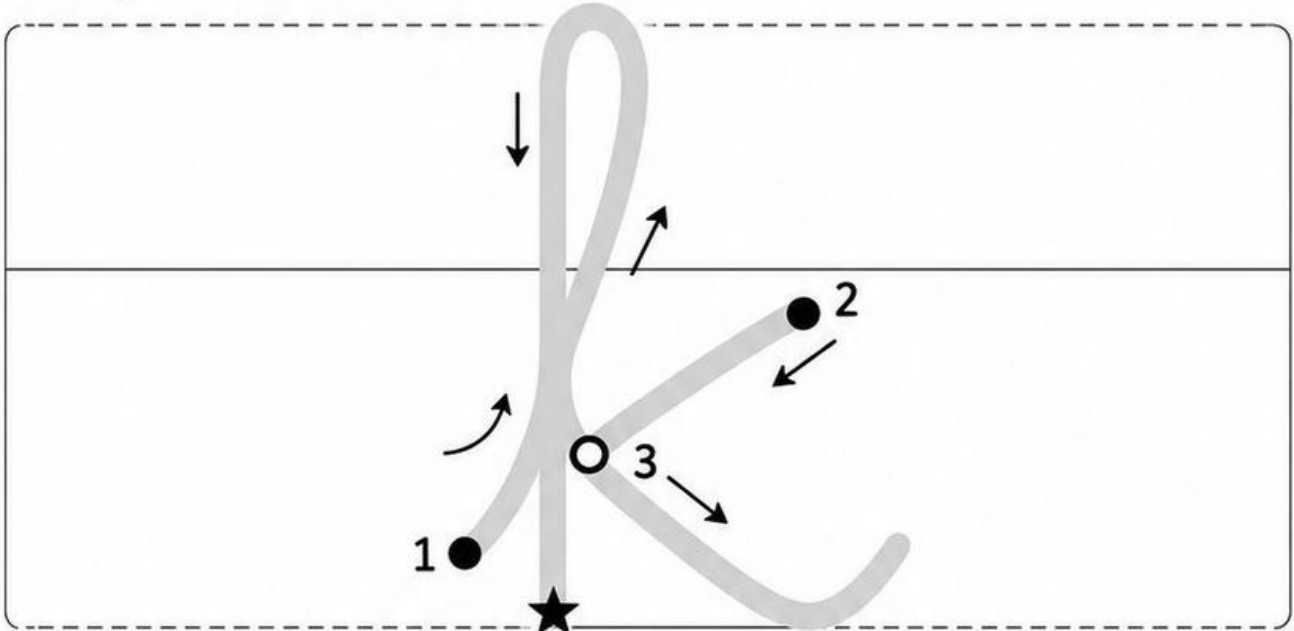

2. Rodea la k.



3. Colorea los dibujos que empiezan por k.

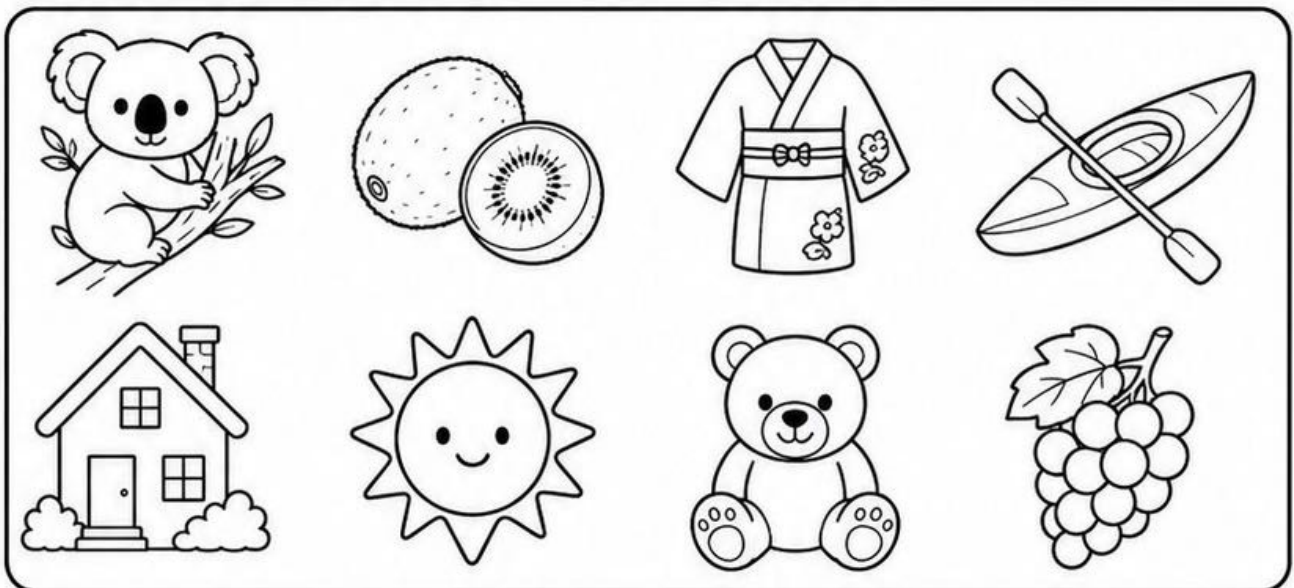

La letra ñ



1. Repasa la letra.

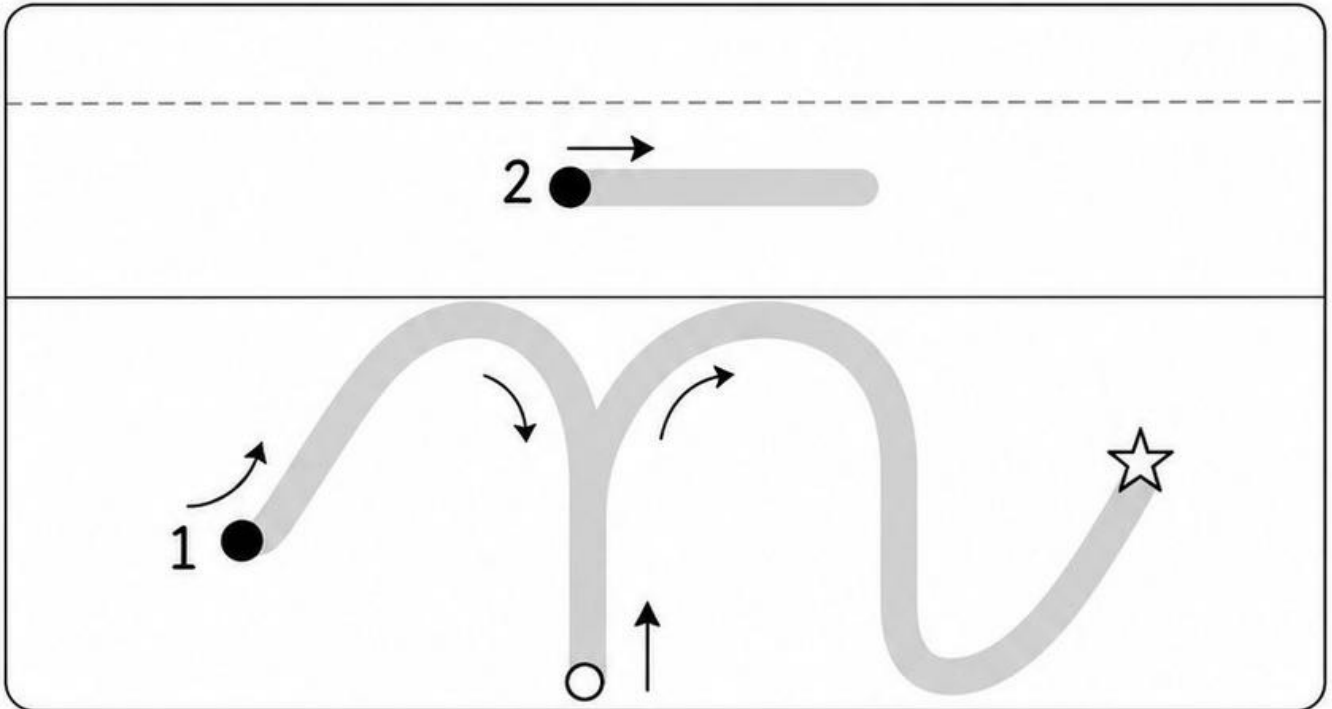

2. Rodea la ñ.

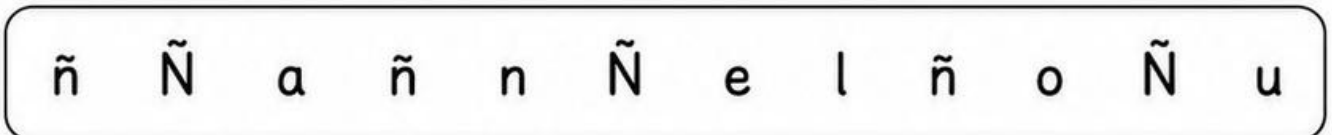

3. Colorea los dibujos que empiezan por ñ.

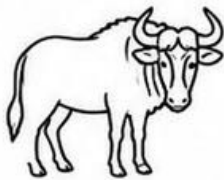

ñu

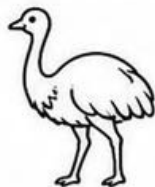

ñandú



ñoquis

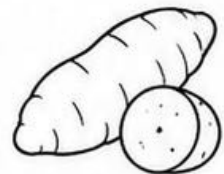

ñame



oso



casa

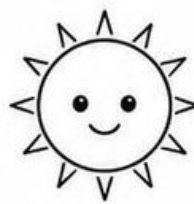

sol

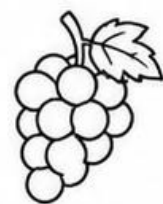

uvas



La letra y



1. Repasa la letra.

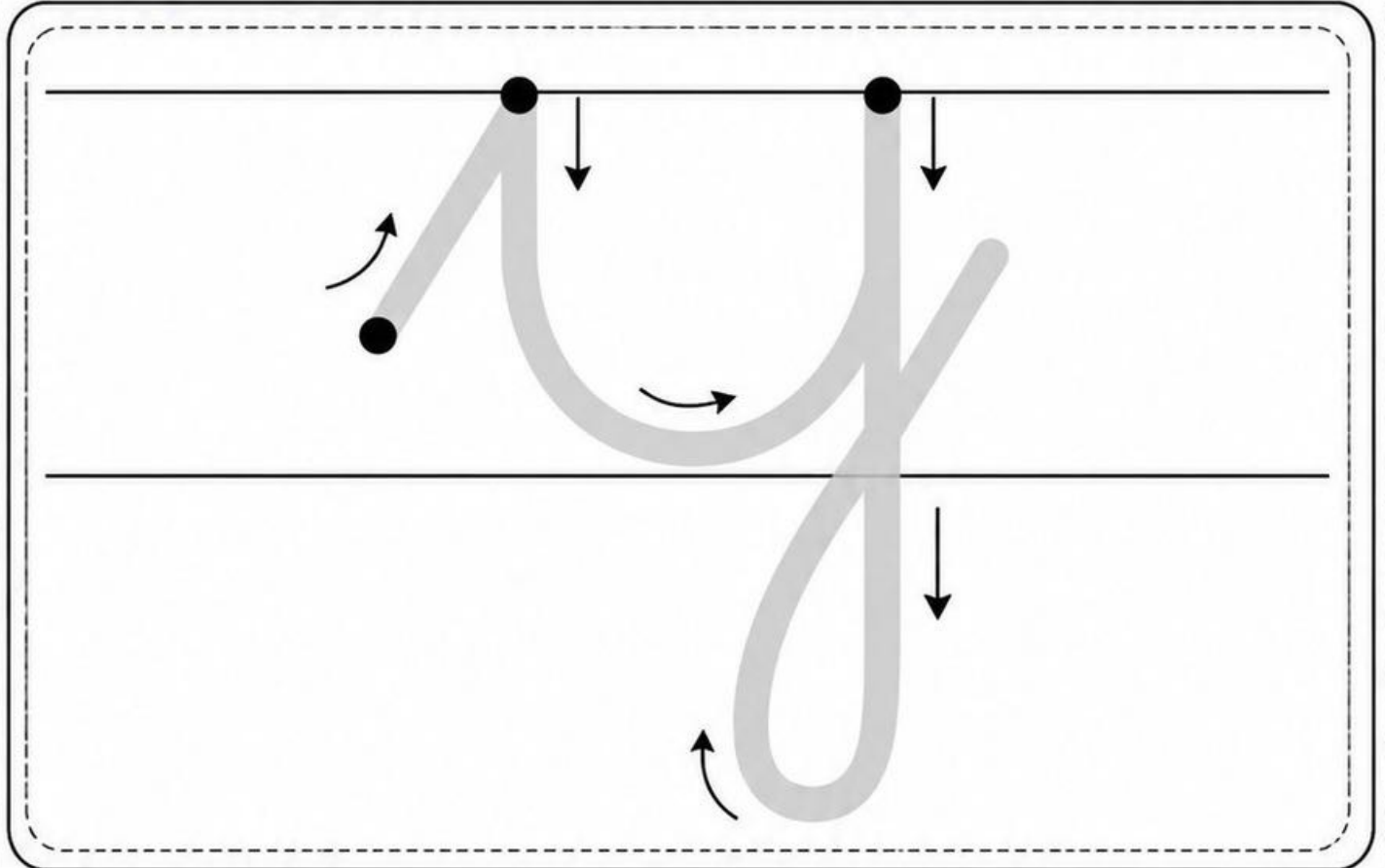

2. Rodea la y.

ya ye yi yo yu ay ey iy oy uy yi yu

3. Colorea los dibujos que empiezan por y.

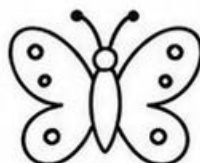
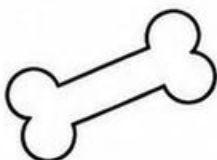
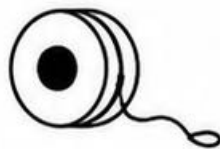

La letra w



1. Repasa la letra.

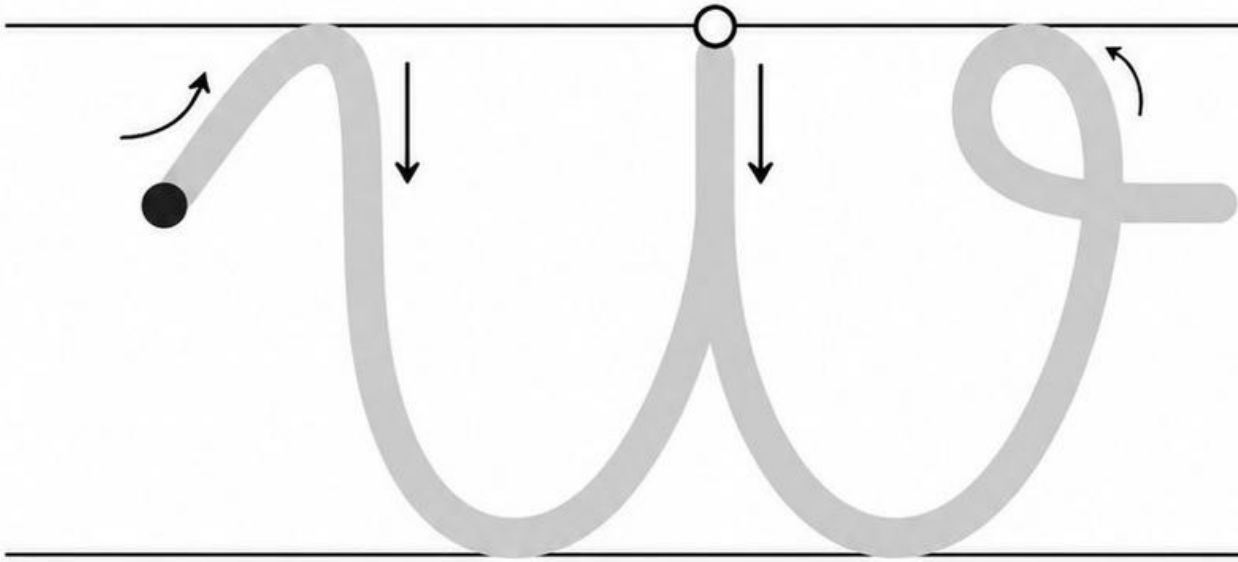

2. Rodea la w.

wa we wi wo wu aw ew iw ow uw wi wu

3. Colorea los dibujos que empiezan por w.

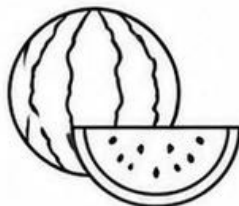
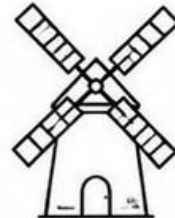
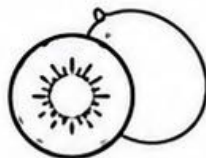
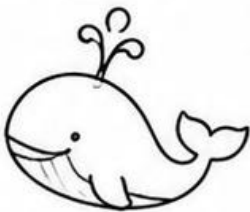

La letra x



1. Repasa la letra.

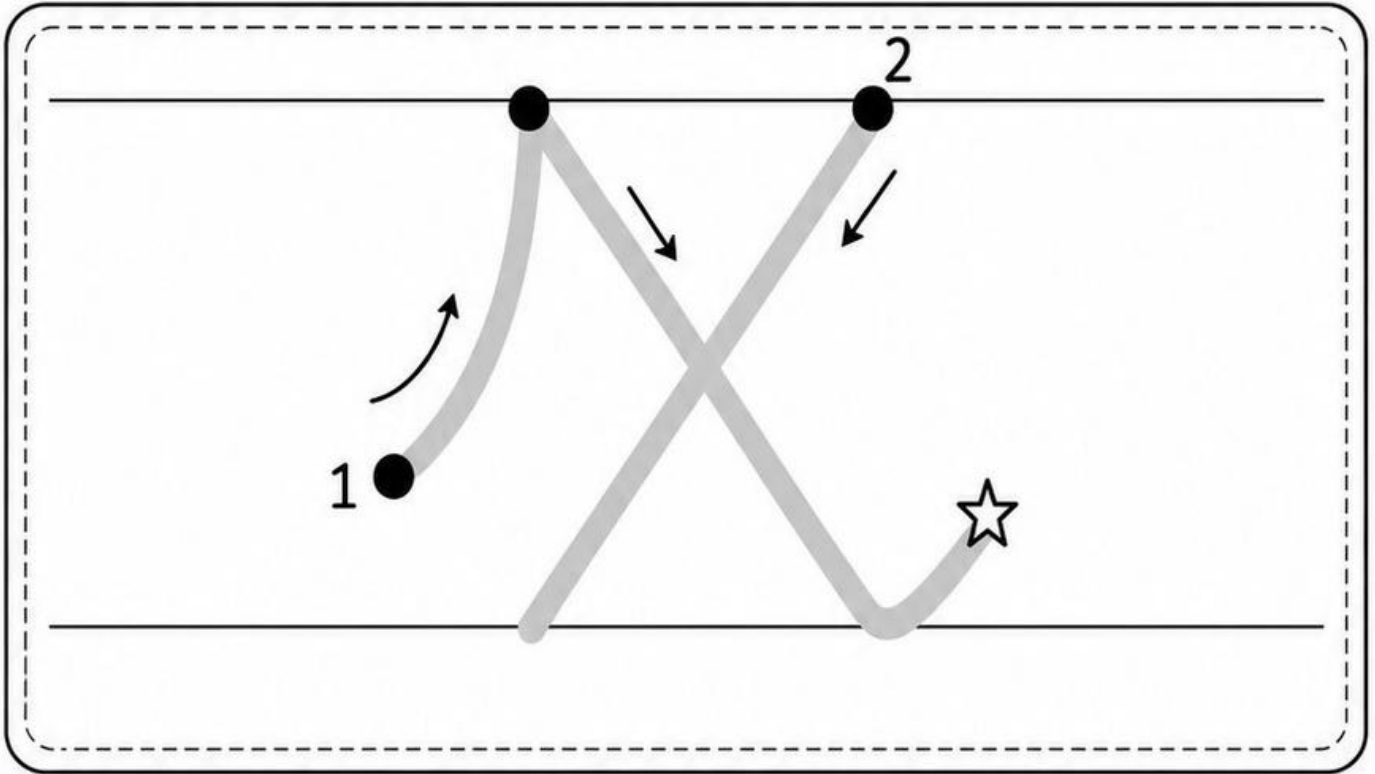

2. Rodea la x.

xa xe xi xo xu ax ex ix ox ux xi xu

3. Colorea los dibujos que empiezan por x.

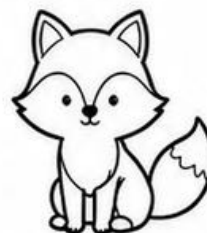
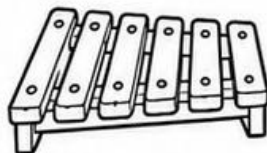
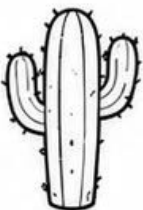
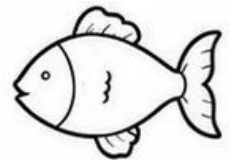
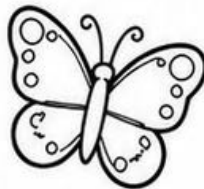
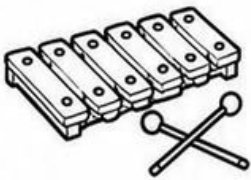

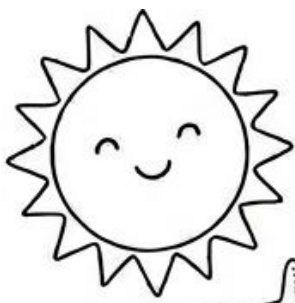

¡APRENDO A SUMAR EN VERANO!

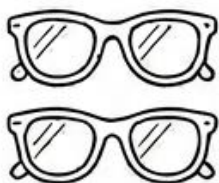
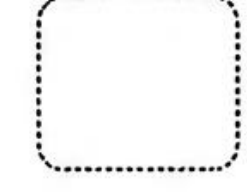
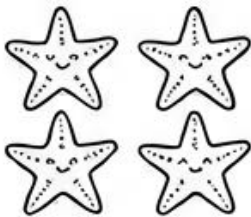
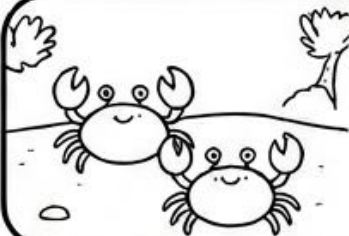
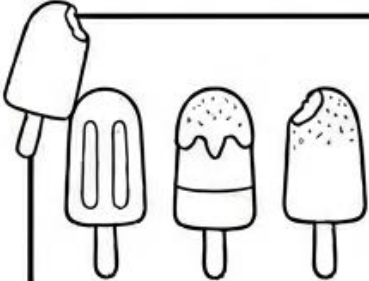
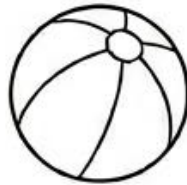

NOMBRE: _____

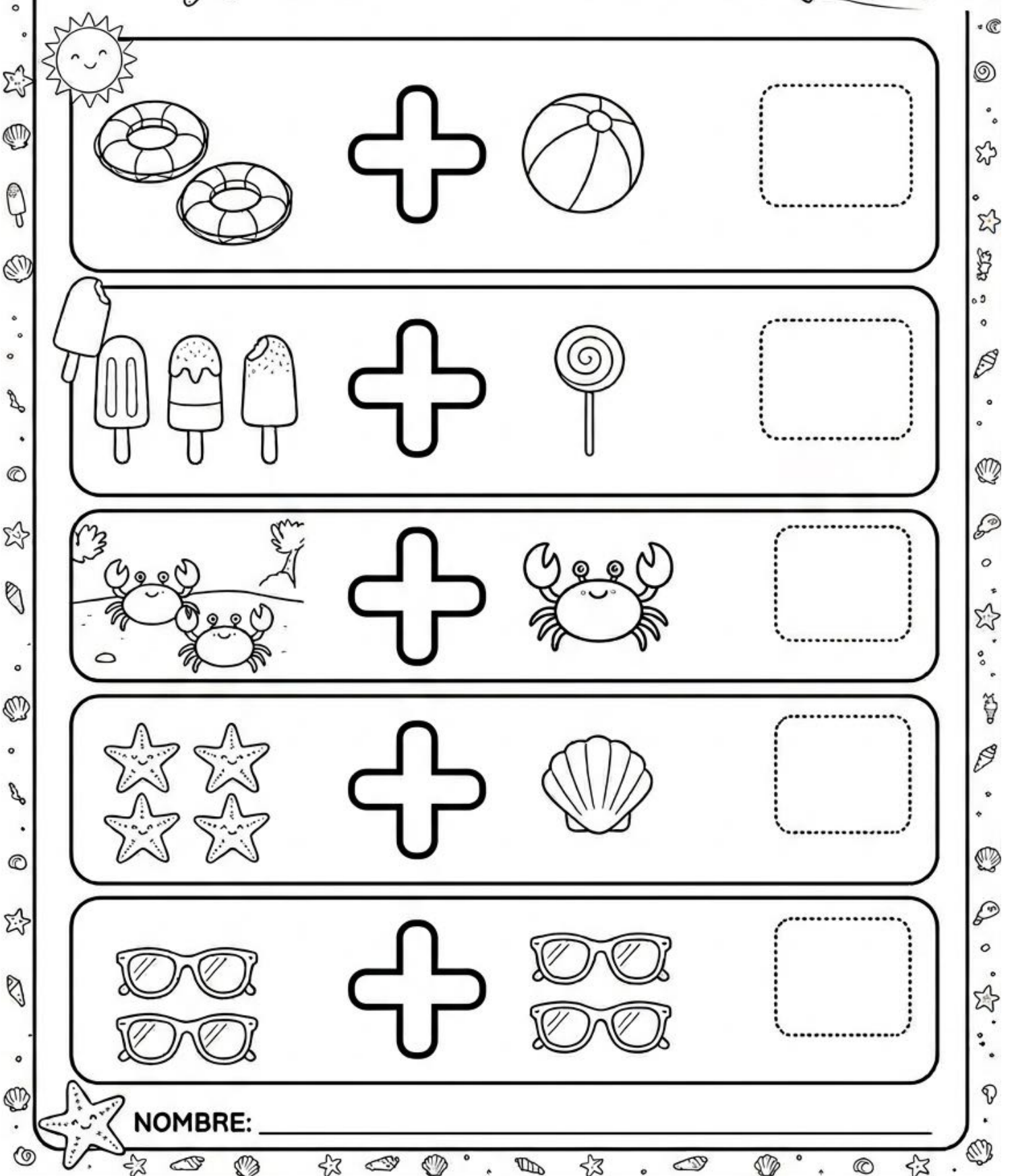



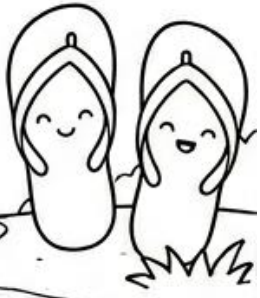

¡SUMAS DIVERTIDAS DE VERANO!

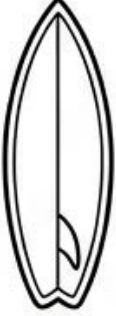
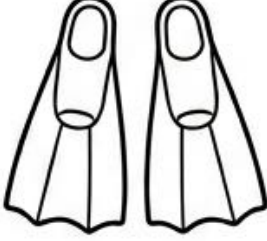

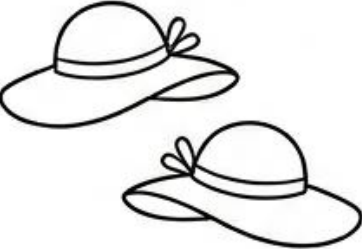

 +
 

 +
 

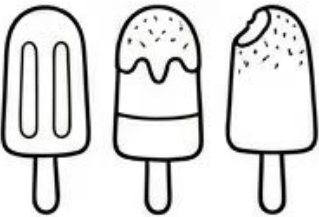
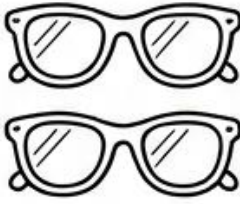
 +
 

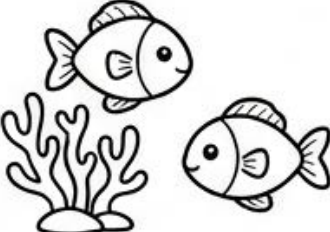
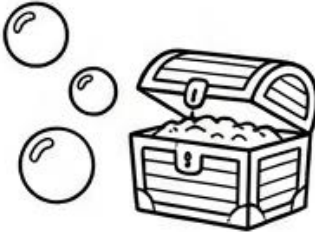
 +
 

 +
 





NOMBRE: _____





¡MIS SUMAS DE VERANO!



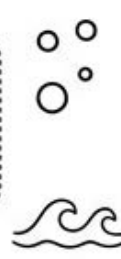

 +
 
 =

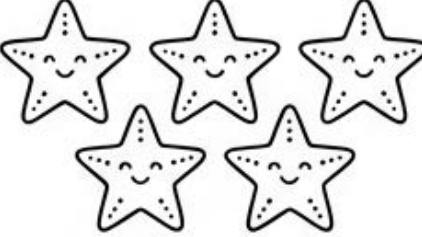
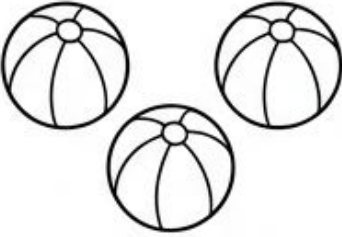

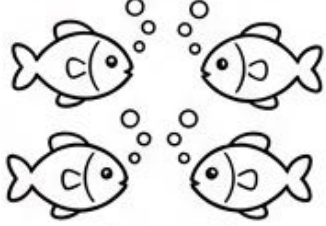

 +
 
 =

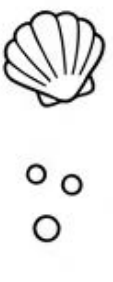

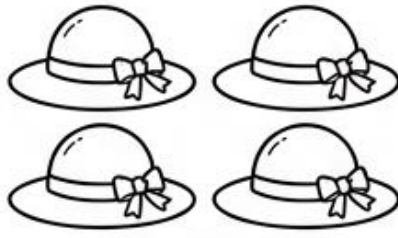
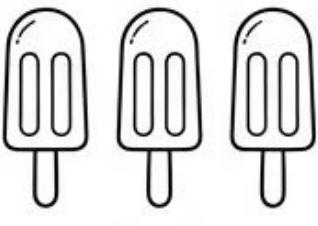

 +
 
 =



 +
 
 =

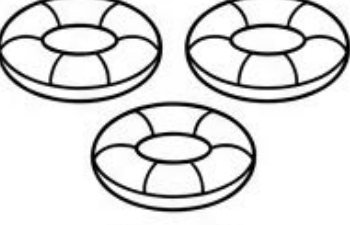

 +
 
 =



NOMBRE: _____





¡SUMAS DE VERANO!



+

=

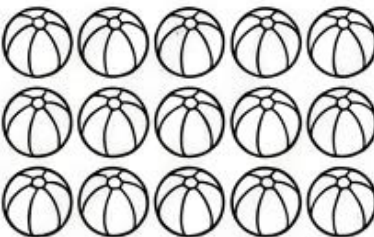

+

=

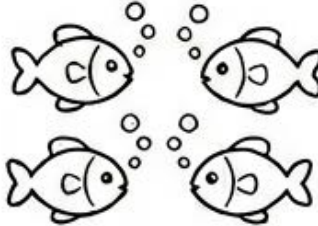

+

=

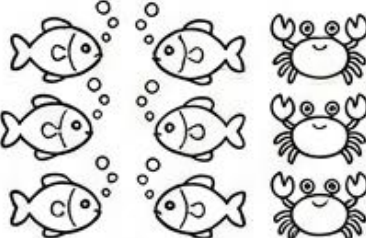
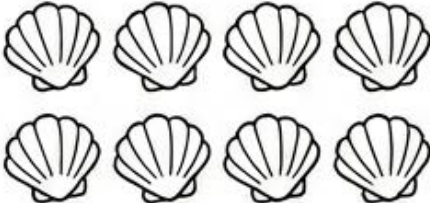

+

=

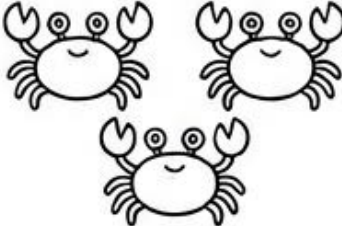

+

=



TOTAL DE OBJETOS CONTADOS: _____

TU NOMBRE:



FECHA:



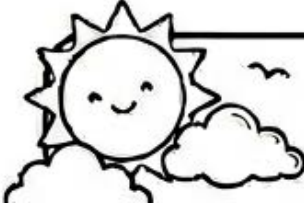

NOMBRE: _____

FECHA: _____

¡ASOCIA NÚMEROS Y DIBUJOS DE VERANO!

Cuenta y une

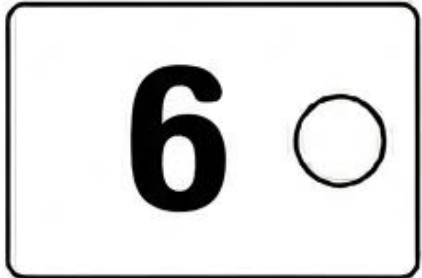
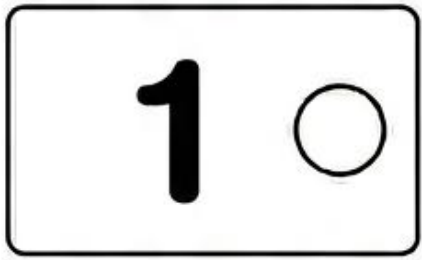
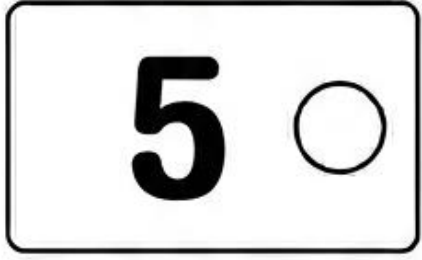
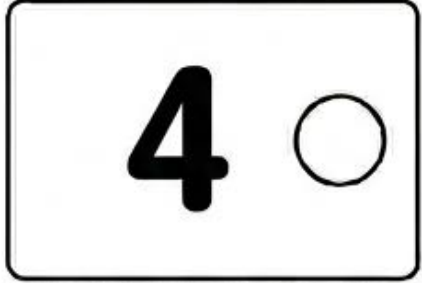
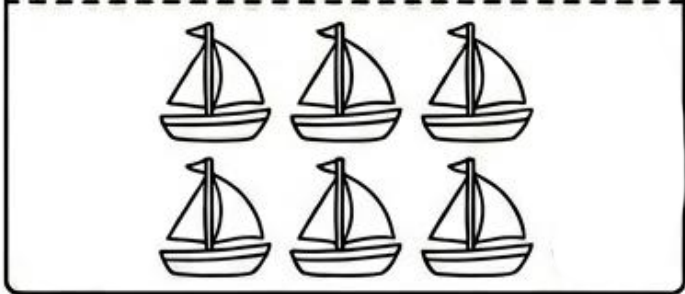
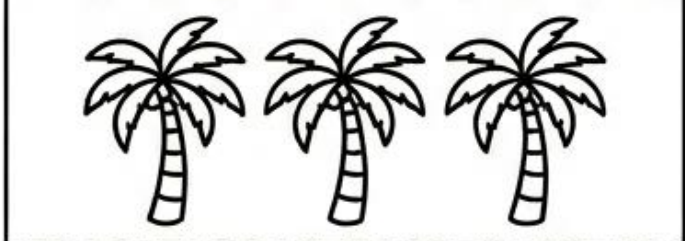
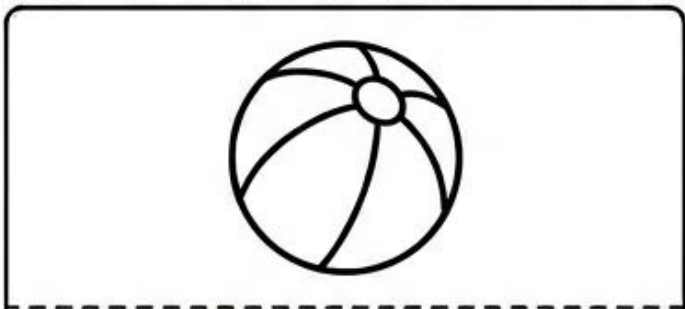
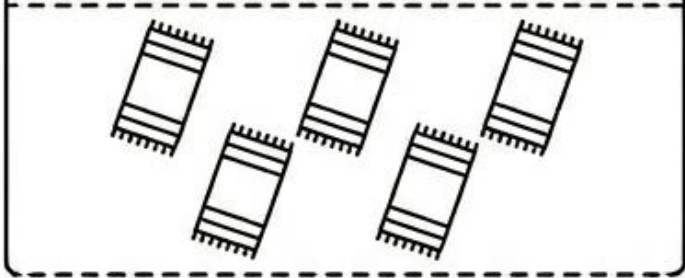
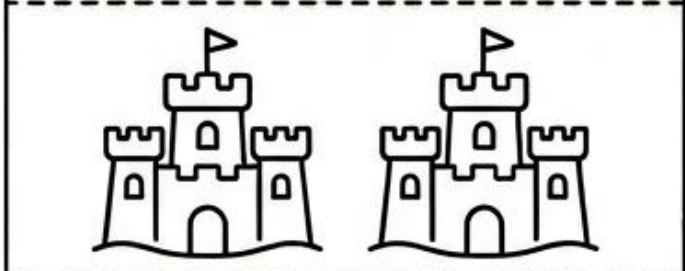
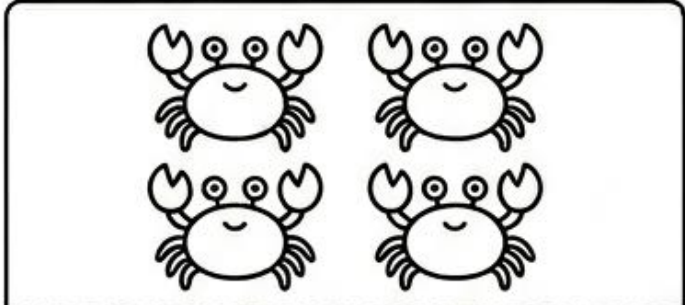

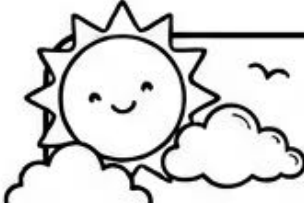

NOMBRE: _____

FECHA: _____

¡ASOCIA NÚMEROS Y DIBUJOS DE VERANO!

Cuenta y une

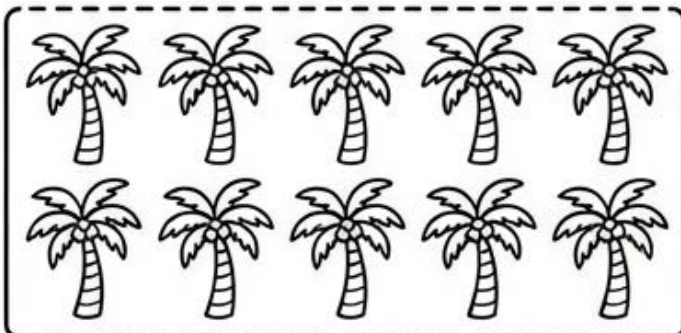
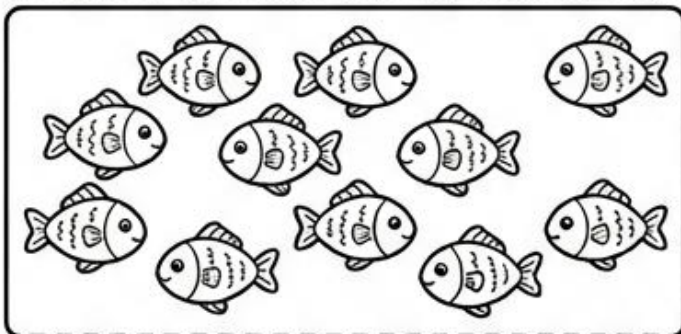
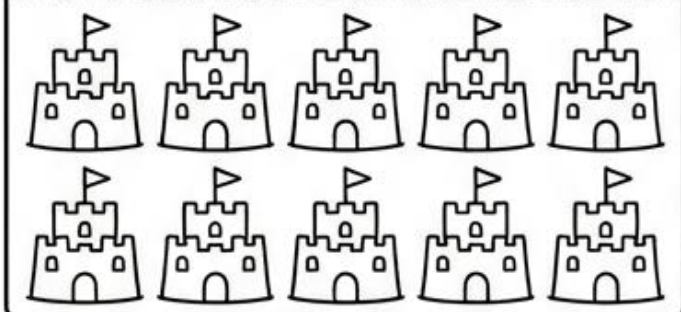
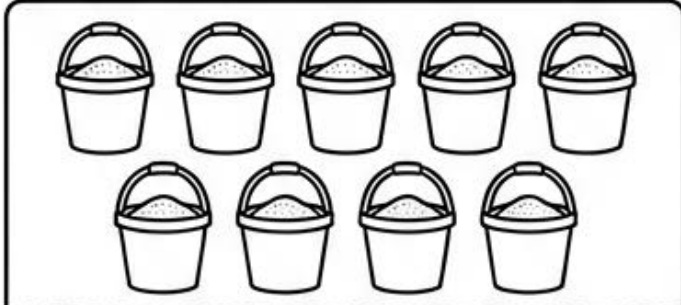

15 ○

9 ○

1 ○

7 ○

11 ○

3 ○



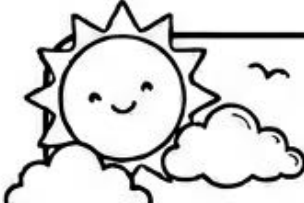

NOMBRE: _____

FECHA: _____



¡ASOCIA NÚMEROS Y DIBUJOS DE VERANO!

Cuenta y une

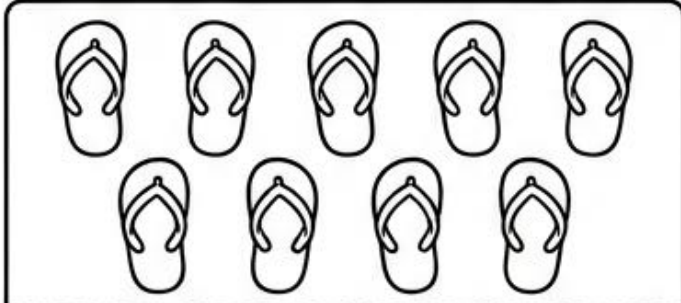

20 ○

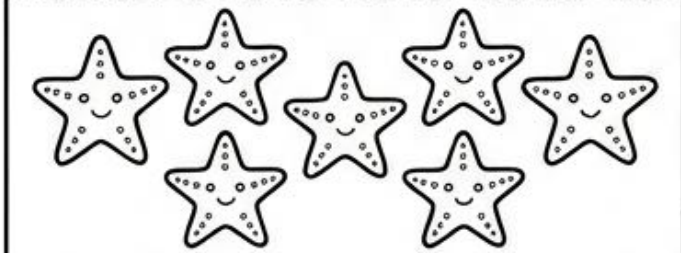

5 ○

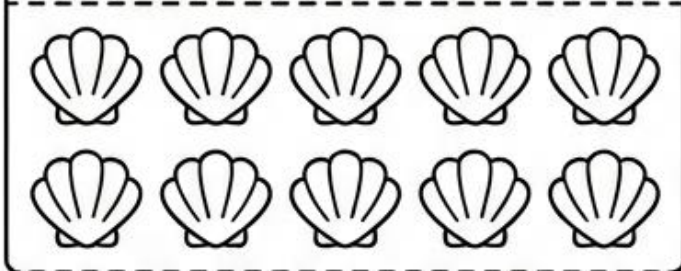

18 ○

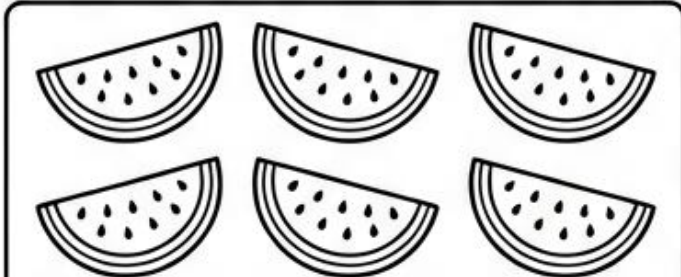

8 ○

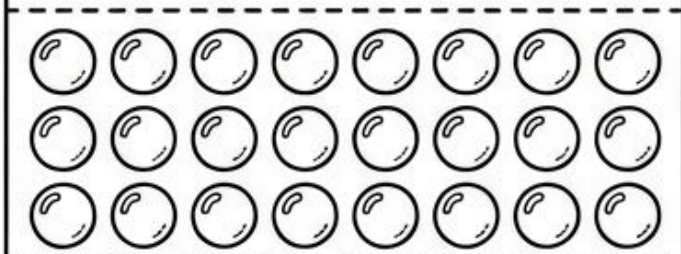

6 ○

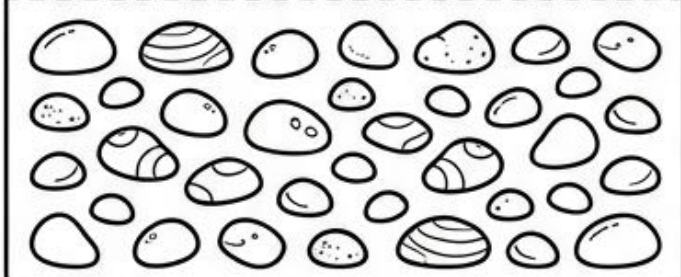

12 ○



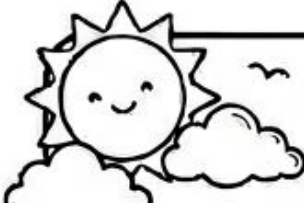

NOMBRE: _____

FECHA: _____

¡ASOCIA NÚMEROS Y DIBUJOS DE VERANO!

Cuenta y une

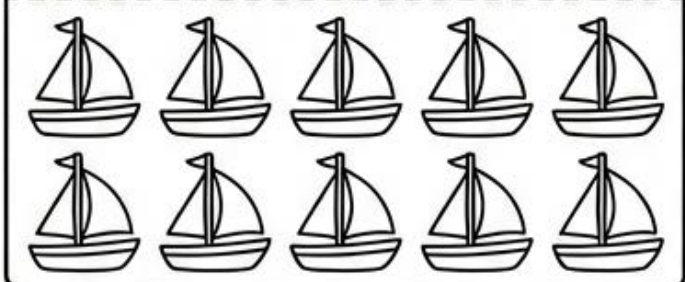
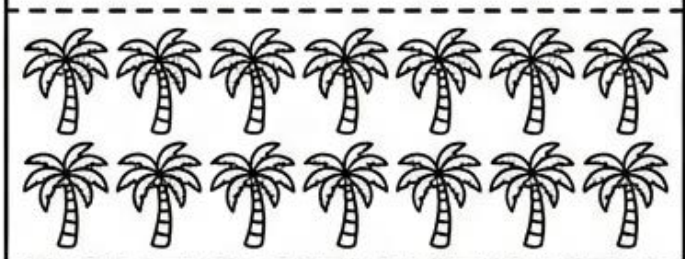
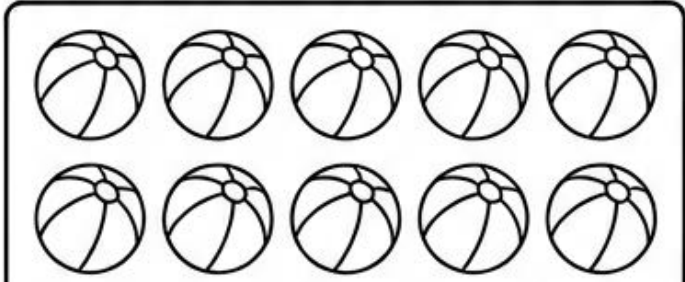
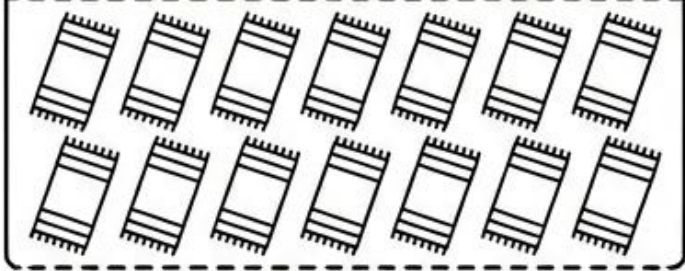
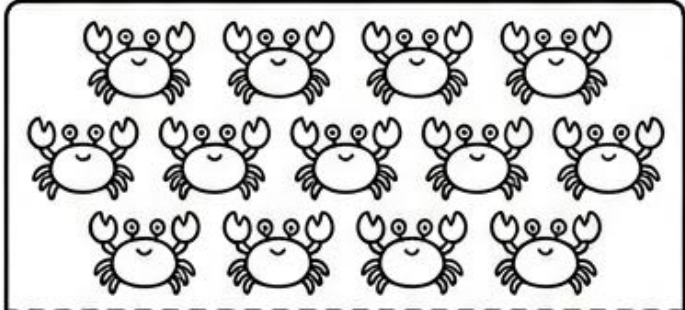

7 ○

19 ○

13 ○

11 ○

9 ○

15 ○



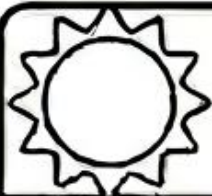

¡HOLA VERANO!



FICHA DE LECTURA Y ESCRITURA (EDAD: 5 AÑOS)
¡VAMOS A LEER Y UNIR LAS SÍLABAS!

1 LEO SÍLABAS DIRECTAS



PA	LA
PE	LE
PI	LI
PU	LU
SA	SA
SE	SI
SO	SU
TA	MA
TE	ME
TI	MI
TO	MO
TU	MU



2 UNIMOS SÍLABAS Y DIBUJAMOS

PA + TO =

ME + SA =

LO + SA =

GA + TO =



3 LEO PALABRAS CORTAS Y SENCILLAS

SOL
MAR
PEZ
BOLA
PALA
OLA
AGUA
CASA
CALOR
NUBE

4 COMPLETO LAS PALABRAS

-
-
-
-

O LA E P L



MI VERANO DE LECTURA

NOMBRE: _____

1 ¡LEE Y PINTA LAS SÍLABAS!

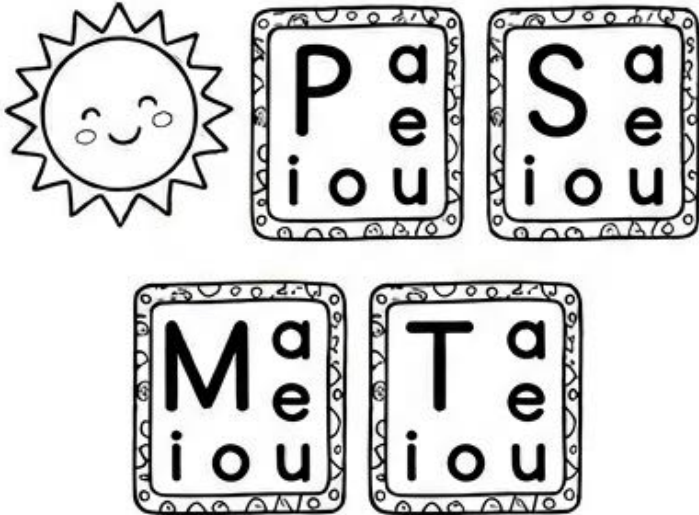

2 ¡LEE LAS PALABRAS!



3 ¡ASOCIA LA PALABRA Y EL DIBUJO!



PEZ
PELOTA
SOL
PLAYA
CASTILLO

4 ¡ESCRIBE Y DIBUJA!

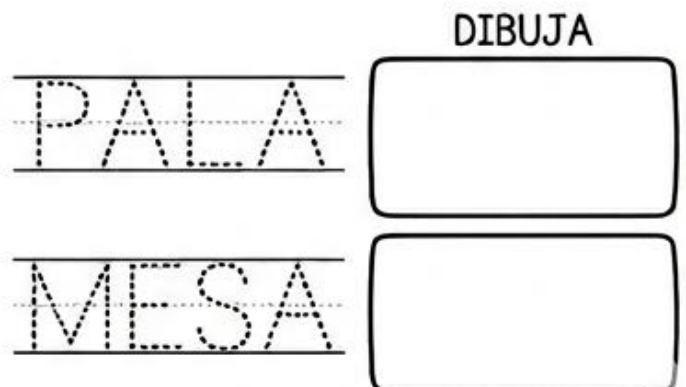
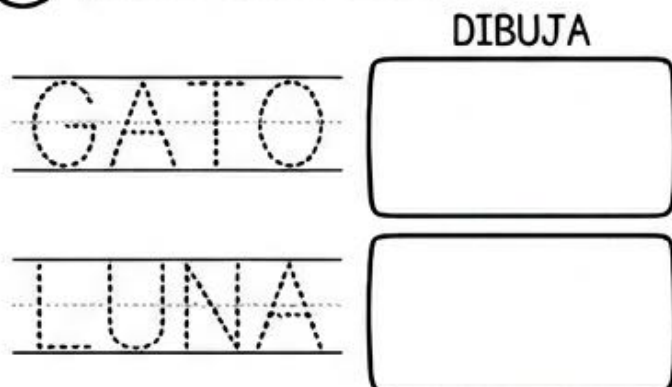

¡MIS SÍLABAS DE VERANO!

NOMBRE: _____ FECHA: _____

1. LEE Y COLOREA EL DIBUJO



SOL



CUBO

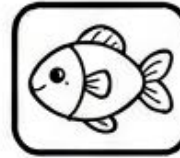

PEZ

2. UNE LA SÍLABA CON EL DIBUJO



• PA

• HE

• PE

• O

3. ESCRIBE LA PALABRA Y COLOREA

A.  PAL + ME + RA = PALMERA

B.  PE LO TA = PELOTA

C.  HE LA DO = HELADO

¡MI SEMANA DIVERTIDA DE VERANO!

Nombre: _____

Fecha: _____

Colorea

DÍAS DE LA SEMANA

Dibuja



Lunes Martes Miércoles Jueves Viernes Sábado Domingo

¡AYER, HOY Y MAÑANA!

AYER

PASADO



Estaba... _____



HOY

AHORA



Estoy... _____



MAÑANA

FUTURO



Estaré... _____



Sigue la flecha

¡APRENDIENDO LAS HORAS EN PUNTO!

(muy básico)



La hora en punto
¡Son las 9 en punto!

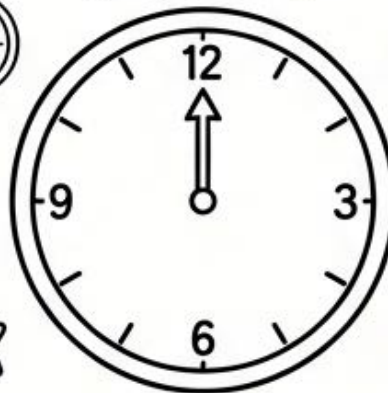

¡Son las 12 en punto!
(Mediodía)

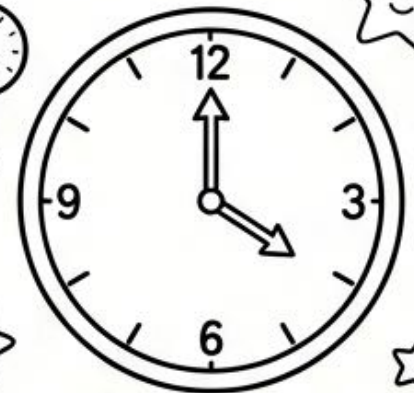

La hora en punto
¡Son las 4 en punto!



¡OTRO DÍA DIVERTIDO DE VERANO!

Nombre: _____

Fecha: _____

MI DÍA DE VERANO

MAÑANA

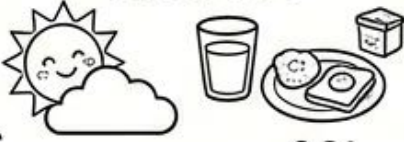

SOL

MEDIODÍA



COMIDA

TARDE



PLAYA

NOCHE



LUNA

AYER



RECUERDO

ACTIVIDADES DE HOY



Hice esto / Haré esto



Hice esto / Haré esto



Hice esto / Haré esto

ACTIVIDADES DE AYER



Hice esto / Haré esto



Hice esto / Haré esto

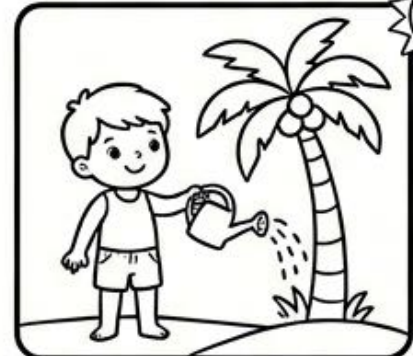

Hice esto / Haré esto

DÍA DE LA SEMANA

Lunes

Martes

Miércoles

Jueves

Viernes

Sábado

Domingo